

ANALOG MULTIPLEXER/DEMULTIPLEXER

4067B-SINGLE 16-CHANNEL
4097B-DIFFERENTIAL 8-CHANNEL

- **LOW ON RESISTANCE:** 125Ω (typ.) OVER 15 V_{p-p} SIGNAL INPUT RANGE FOR V_{DD} - V_{SS} = 15V
- **HIGH OFF RESISTANCE:** CHANNEL LEAKAGE OF ±10pA (typ.) @ V_{DD} - V_{SS} = 10V
- **MATCHED SWITCH CHARACTERISTICS:** ΔR_{ON} = 5Ω (typ.) FOR V_{DD} - V_{SS} = 15V
- **VERY LOW QUIESCENT POWER DISSIPATION** UNDER A DIGITAL CONTROL INPUT AND SUPPLY CONDITIONS: 0.2μW (typ.) @ V_{DD} - V_{SS} = 10V
- **BINARY ADDRESS DECODING ON CHIP**
- **QUIESCENT CURRENT SPECIFIED TO 20V** FOR HCC DEVICE
- **STANDARDIZED SYMMETRICAL OUTPUT CHARACTERISTICS**
- **5V, 10V AND 15V PARAMETRIC RATINGS**
- **INPUT CURRENT OF 100nA** AT 18V AND 25°C FOR HCC DEVICE
- **100% TESTED FOR QUIESCENT CURRENT**
- **MEETS ALL REQUIREMENTS OF JEDEC TENTATIVE STANDARD No 13A, "STANDARD SPECIFICATIONS FOR DESCRIPTION OF B-SERIE CMOS DEVICES"**

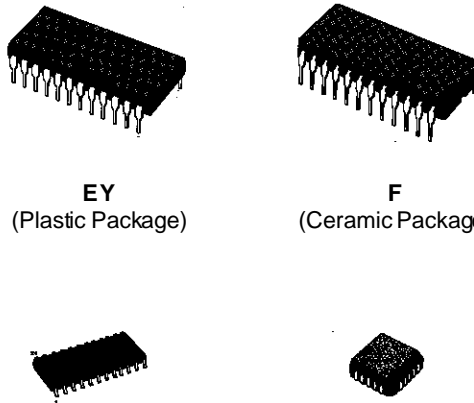

EY
(Plastic Package)

F
(Ceramic Package)

M1
(Micro Package)

C1
(Chip Carrier)

ORDER CODES :
HCC40XXBF HCF40XXBM1
HCF40XXBEY HCF40XXBC1

PIN CONNECTIONS

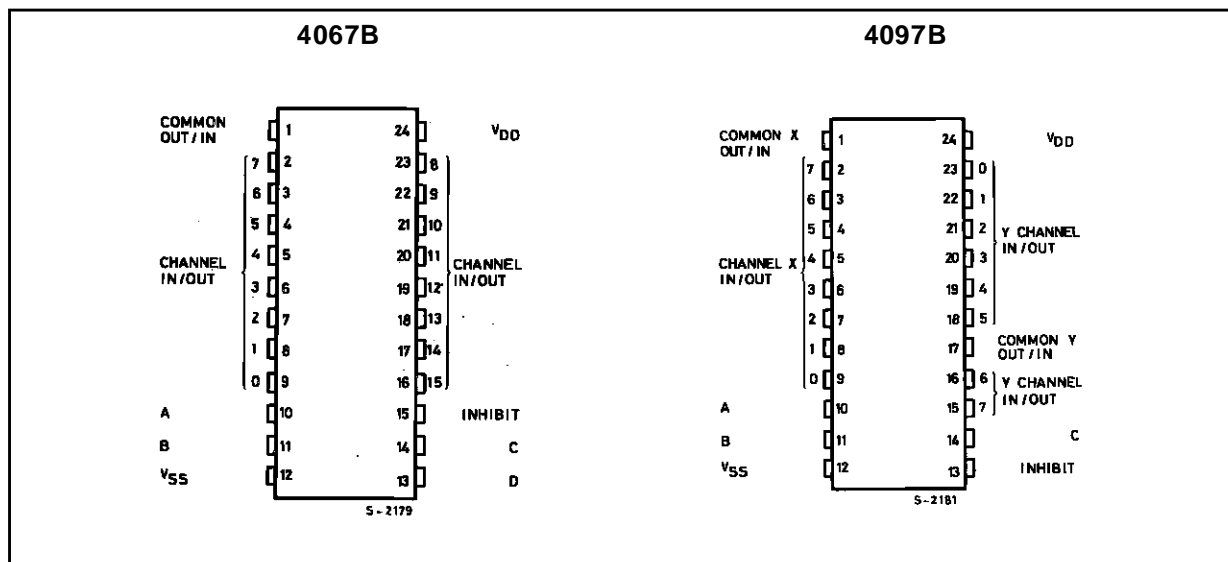

HCC/HCF4067B HCC/HCF4097B

DESCRIPTION

The **HCC4067B**, **HCC4097B** (extended temperature range) and **HCF4067B**, **HCF4097B** (intermediate temperature range) are monolithic integrated circuits available in 24-lead dual in line plastic or ceramic package.

The **HCC/HCF4067B** and **HCC/HCF4097B** COS/MOS analog multiplexers/demultiplexers are digitally controlled analog switches having low ON impedance, low OFF leakage current and internal

address decoding. in addition, the ON resistance is relatively constant over the full input-signal range.

The **HCC/HCF4067B** is a 16-channel multiplexer with four binary control inputs A, B, C, D, and an inhibit input, arranged so that any combination of the inputs selects one switch.

The **HCC/HCF4097** is a differential 8-channel multiplexer having three binary control inputs A, B, C, and an inhibit input. The inputs permit selection of one

FUNCTIONAL DIAGRAM

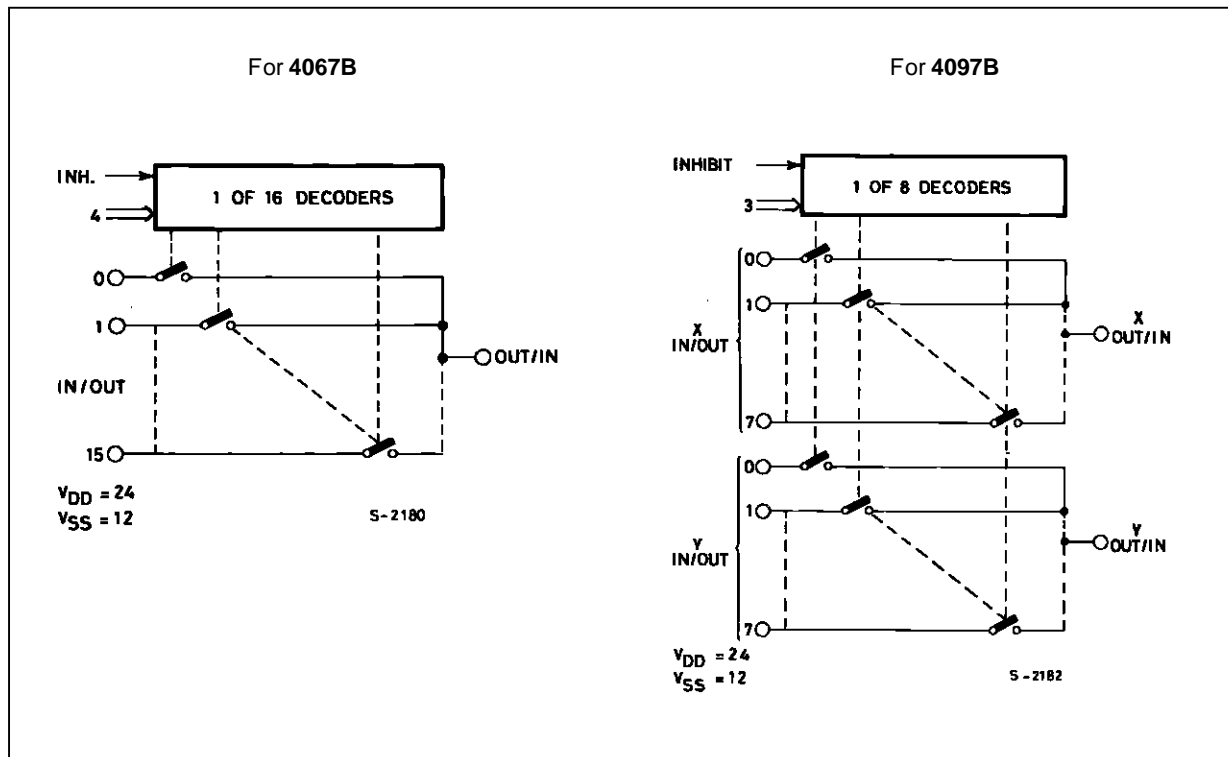

LOGIC DIAGRAM

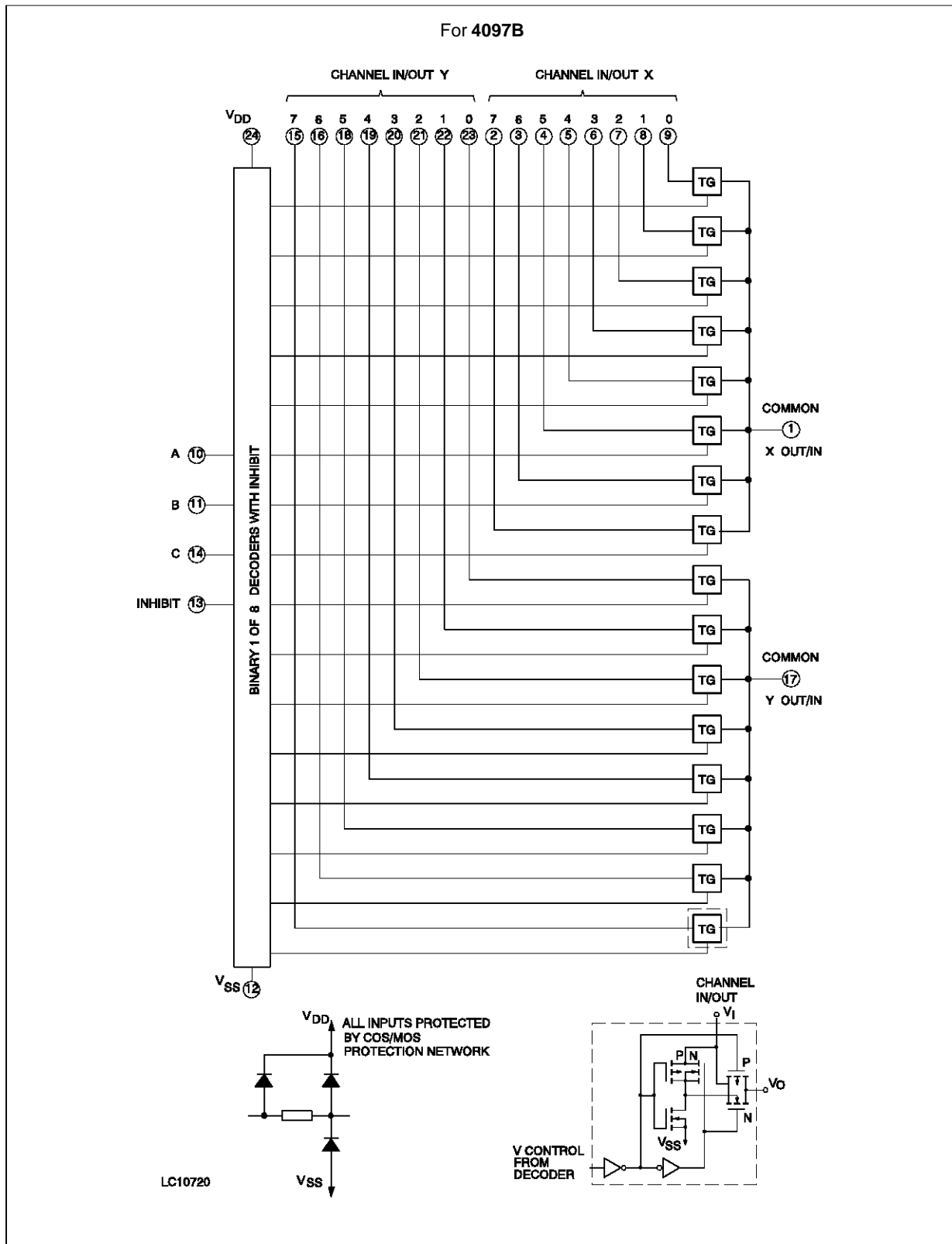

TRUTH TABLES FOR HCC/HCF4067B

A	B	C	D	INH	SELECTED CHANNEL
X	X	X	X	1	None
0	0	0	0	0	0
1	0	0	0	0	1
0	1	0	0	0	2
1	1	0	0	0	3
0	0	1	0	0	4
1	0	1	0	0	5
0	1	1	0	0	6
1	1	1	0	0	7
0	0	0	1	0	8
1	0	0	1	0	9
0	1	0	1	0	10
1	1	0	1	0	11
0	0	1	1	0	12
1	0	1	1	0	13
0	1	1	1	0	14
1	1	1	1	0	15

TRUTH TABLE FOR HCC/HCF4097B

A	B	C	INH	SELECTED CHANNEL
X	X	X	1	None
0	0	0	0	0X 0Y
1	0	0	0	1X 1Y
0	1	0	0	2X 2Y
1	1	0	0	3X 3Y
0	0	1	0	4X 4Y
1	0	1	0	5X 5Y
0	1	1	0	6X 6Y
1	1	1	0	7X 7Y

ABSOLUTE MAXIMUM RATING

Symbol	Parameter	Value	Unit
V _{DD} *	Supply Voltage: HCC Types HCF Types	-0.5 to +20	V
		-0.5 to +18	V
V _I	Input Voltage	-0.5 to V _{DD} + 0.5	V
I _I	DC Input Current (any one input)	± 10	mA
P _{tot}	Total Power Dissipation (per package) Dissipation per Output Transistor for Top = Full Package Temperature Range	200	mW
		100	mW
T _{op}	Operating Temperature: HCC Types HCF Types	-55 to +125	°C
		-40 to +85	°C
T _{stg}	Storage Temperature	-65 to +150	°C

Stresses above those listed under "Absolute Maximum Ratings" may cause permanent damage to the device. This is a stress rating only and functional operation of the device at these or any other conditions above those indicated in the operational sections of this specification is not implied. Exposure to absolute maximum rating conditions for external periods may affect device reliability.

* All voltage values are referred to V_{SS} pin voltage.

RECOMMENDED OPERATING CONDITIONS

Symbol	Parameter	Value	Unit
V _{DD}	Supply Voltage: HCC Types HCF Types	3 to 18	V
		3 to 15	V
V _I	Input Voltage	0 to V _{DD}	V
T _{op}	Operating Temperature: HCC Types HCF Types	-55 to +125	°C
		-40 to +85	°C

HCC/HCF4067B HCC/HCF4097B

STATIC ELECTRICAL CHARACTERISTICS (over recommended operating conditions)

Symbol	Parameter		Test Conditions				Value						Unit																				
			V _{IS} (V)	V _{EE} (V)	V _{SS} (V)	V _{DD} (V)	T _{LOW} *		25 °C			T _{HIGH} *																					
							Min.	Max.	Min.	Typ.	Max.	Min.		Max.																			
I _L	Quiescent Supply Current	HCC types				5		5		0.04	5		150	μA																			
						10		10		0.04	10		300																				
						15		20		0.04	20		600																				
						20		100		0.08	100		3000																				
		HCF types				5		20		0.04	20		150																				
						10		40		0.04	40		300																				
					15		80		0.04	80		600																					
SWITCH																																	
R _{ON}	On Resistance	HCC types	0 ≤ V _I ≤ V _{DD}	0	0	5		800		470	1050		1300	Ω																			
						10		310		180	400		580																				
						15		200		125	240		320																				
		HCF types				5		850		470	1050		1200																				
						10		330		180	400		520																				
						15		210		125	240		300																				
ΔON	Resistance ΔR _{ON} (Between any two channels)			0	0	5				10			Ω																				
						10				10																							
						15				5																							
OFF (●) Channel Leakage Current	Any Channel OFF	HCC types	0	0	18		100		±0.1	100		1000	μA																				
		HCC types												0	0	18		100		±0.1	100		1000										
		HCF types																						0	0	15		300		±0.1	300		1000
		HCF types																															
C	Capacitance Input Output for 4067 Output for 4097 Feedthrough												pF																				
CONTROL																																	
V _{IL}	Input Low Voltage		= V _{DD} thru 1KΩ	V _{EE} =V _{SS} R _L =1KΩ to V _{SS} I _{IS} < 2μA (on all OFF channels)	5		1.5			1.5		1.5	V																				
					10		3		3		3																						
					15		4		4		4																						
V _{IH}	Input High Voltage				5	3.5		3.5				3.5	V																				
					10	7		7			7																						
					15	11		11			11																						
I _{IH} I _{IL}	Input Leakage Current	HCC types	V _I = 0/18V		18		±0.1		±10 ⁻³	±0.1		±1	μA																				
		HCF types												V _I = 0/15V	15		±0.3		±10 ⁻³	±0.3		±1											
C _I	Input Capacitance		Any Address or Inhibit Input						5	7.5			pF																				





• Determined by minimum feasible leakage measurement for automatic testing

* T_{LOW} = -55 °C for HCC device; -40 °C for HCF device.

* T_{HIGH} = +125 °C for HCC device; +85 °C for HCF device.

The Noise Margin for both "1" and "0" level is: 1V min. with V_{DD} = 5V, 2V min. with V_{DD} = 10V, 2.5V min. with V_{DD} = 15V

DYNAMIC ELECTRICAL CHARACTERISTICS ($T_{amb} = 25\text{ }^{\circ}\text{C}$, $C_L = 50\text{ pF}$, $R_L = 200\text{ K}\Omega$, typical temperature coefficient for all V_{DD} values is $03\text{ } \%/^{\circ}\text{C}$, all input rise and fall times = 20 ns)

Symbol	Parameter	Test Conditions						Value		Unit						
		V _C (V)	R _L (K Ω)	f _i (KHz)	V _i (V)	V _{SS} (V)	V _{DD} (V)	Typ.	Max.							
SWITCH																
t _{pd}	Propagation Delay Time (Signal Input to Output)	= V _{DD}	200		0	5			30	60	ns					
									15	30						
									11	20						
	Frequency Response Channel "ON" (Sine Wave Input) at $20\text{ Log } \frac{V_O}{V_I} = -3\text{ dB}$	= V _{DD}	1	5 (●)	0	10		V _O at Common OUT/IN	4067B	14	ns					
									4097B	20						
									V _O at Any Channel			60				
	Feedthrough (All Channels OFF) at $20\text{ Log } \frac{V_O}{V_I} = -40\text{ dB}$	= V _{SS}	1	5 (●)	0	10		V _O at Common OUT/IN	4067B	20	MHz					
									4097B	12						
									V _O at Any Channel			8				
	Frequency Signal Crosstalk at $20\text{ Log } \frac{V_{\alpha(B)}}{V_{I(A)}} = -40\text{ dB}$	V _{C(A)} =V _{DD} V _{C(B)} =V _{SS}	1	5 (●)	0	10		Between Any two (A and B) Channels		1	MHz					
								Between Sections (A and B) 4097B only	Measured on common	10						
									Measured on Any Channel	18						
t _w	Sine Wave Distortion (f _{is} = 1KHz sine wave)	5	10	1	2 (●)	0	5		0.3		%					
									10	10		1	3 (●)	0	10	0.2
									15	10		1	5 (●)	0	15	0.12
CONTROL (address or Inhibit)																
t _{PLH} t _{PHL}	Propagation Delay Time: Address or Inhibit to Signal OUT (Channel Turning ON)		1						0	5	ns					
									0	10						
									0	15						
t _{PLH} t _{PHL}	Propagation Delay Time: Address or Inhibit to Signal OUT (Channel Turning OFF)		0.3						0	5	ns					
									0	10						
									0	15						
	Address or Inhibit to Signal Crosstalk		10*						0	10	mV peak					

(●) Peak to peak voltage symmetrical about $\frac{V_{DD} - V_{SS}}{2}$

(*) Both ends of channel

HCC/HCF4067B HCC/HCF4097B

Typical ON Resistance vs Input Signal Voltage (All Types)

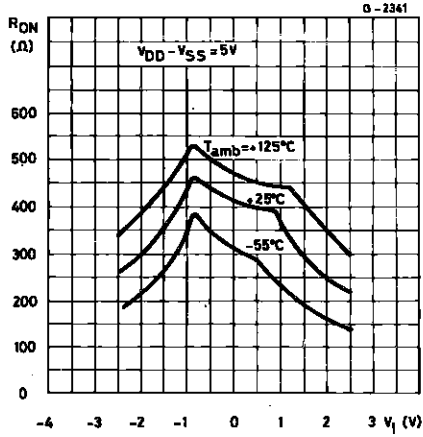

Typical ON Resistance vs Input Signal Voltage (All Types)

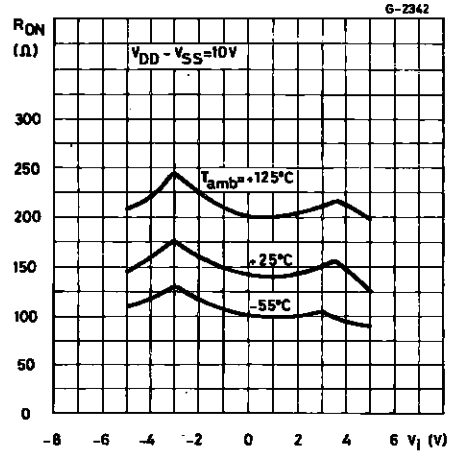

Typical ON Resistance vs Input Signal Voltage (All Types)

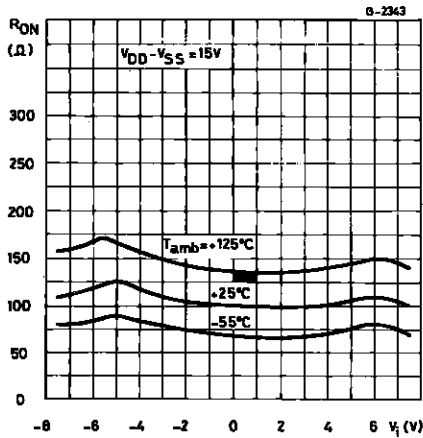

Typical ON Resistance vs Input Signal Voltage (All Types)

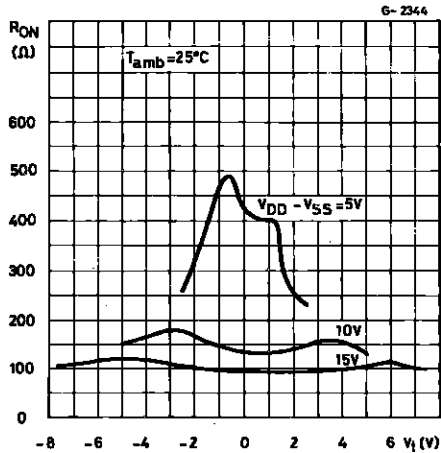

TEST CIRCUITS

OFF Channel Leakage Current Any Channel OFF

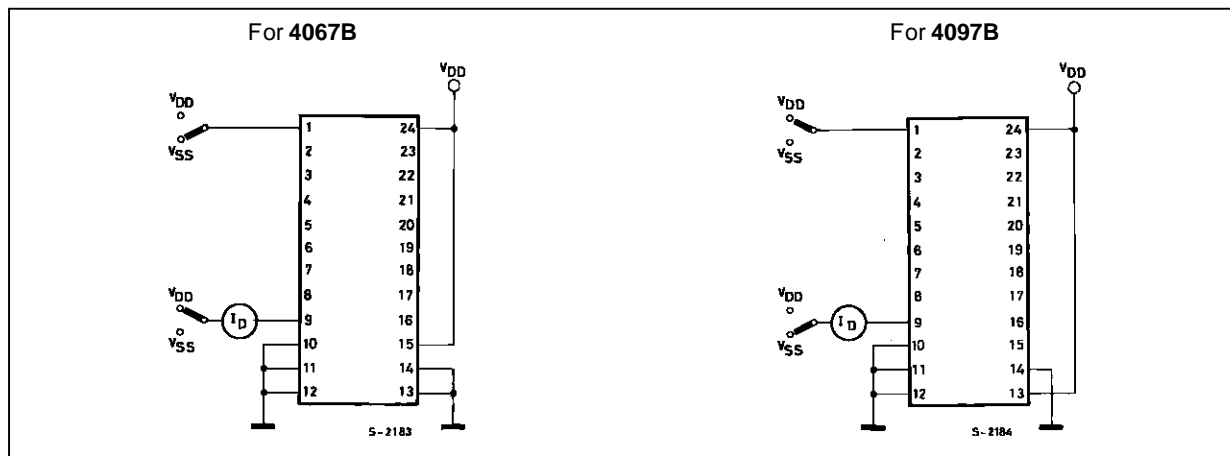

OFF Channel Leakage Current All Channels OFF

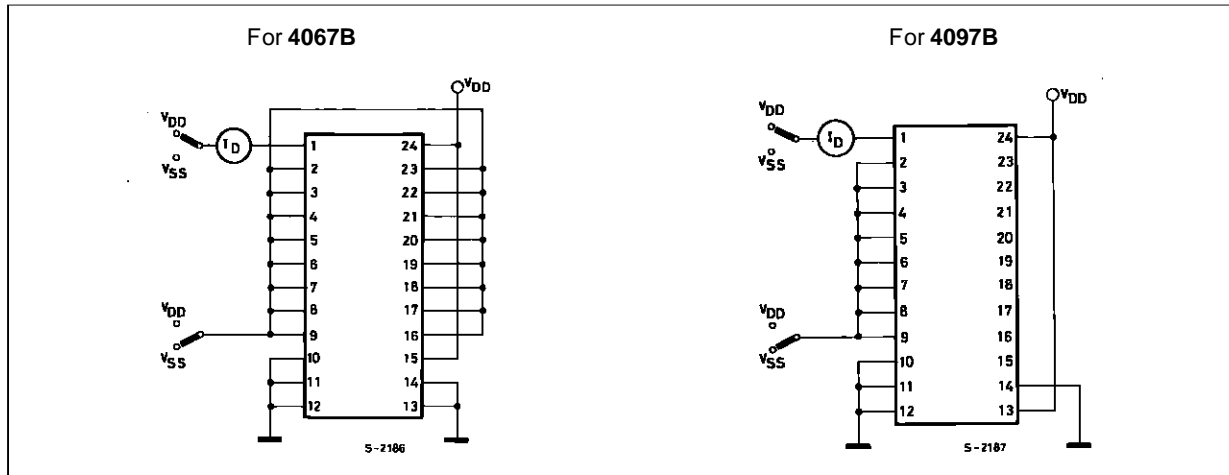

Input Voltage Measure < 2 μ A an All OFF Channels (e.g. Channel 12)

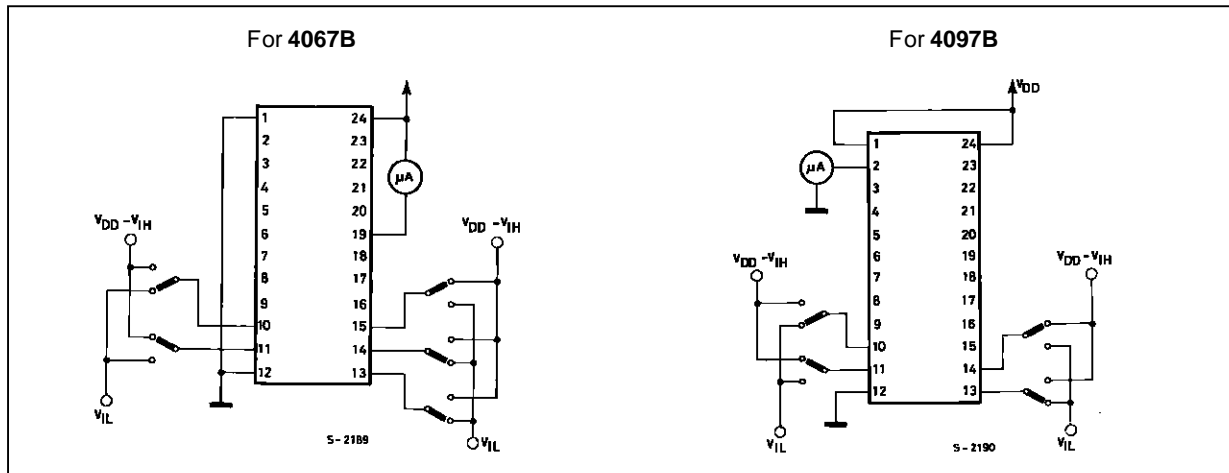

Quiescent Device Current

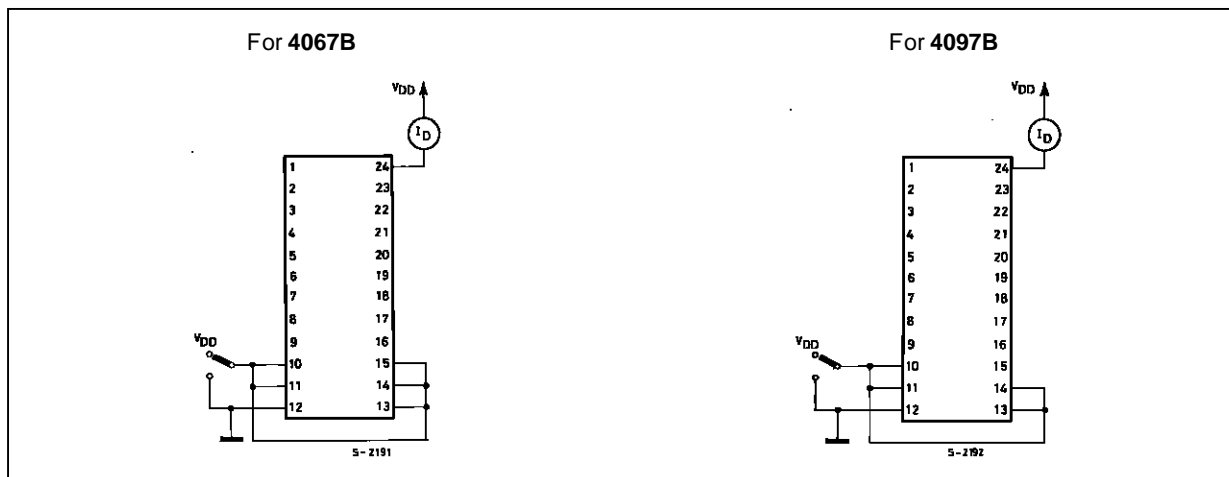

HCC/HCF4067B HCC/HCF4097B

Turn-on and Turn-off Propagation Delay Address Select Input to Signal Output (e. g. Channel 0)

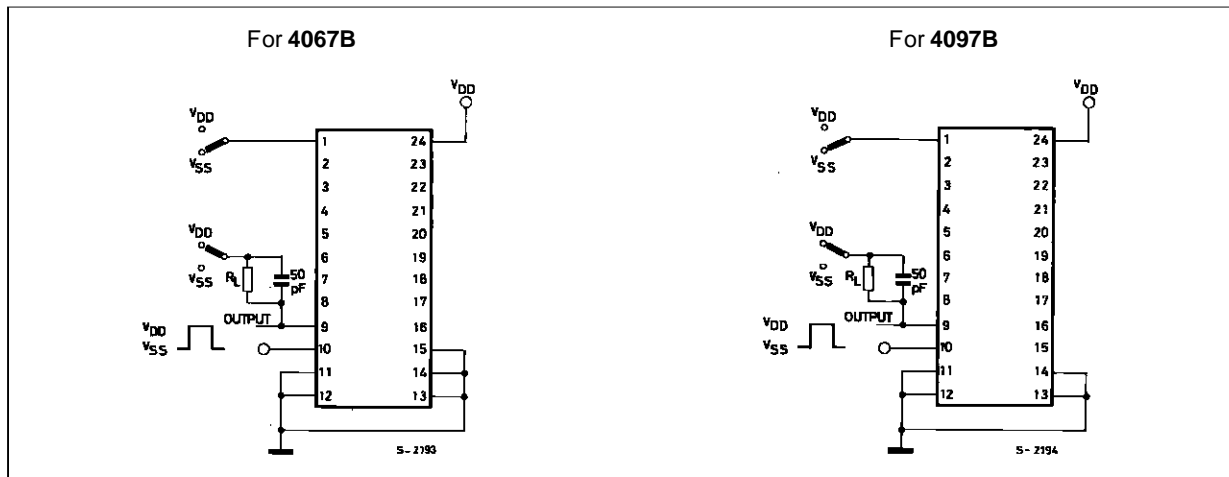

Turn-on and Turn-off Propagation Delay-Inhibit Input to Signal Output (e. g. Channel 1)

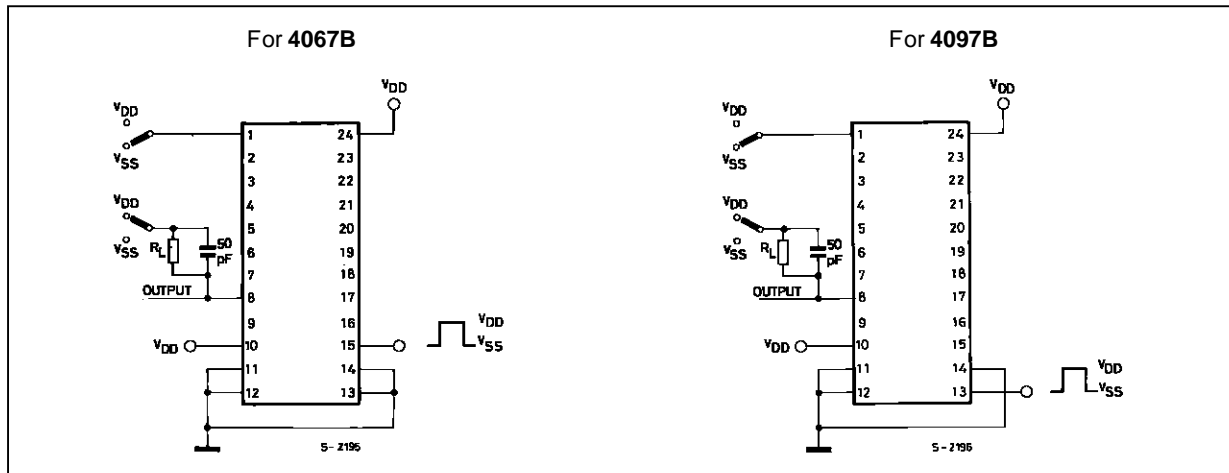

Channel ON Resistance Measurement Circuit

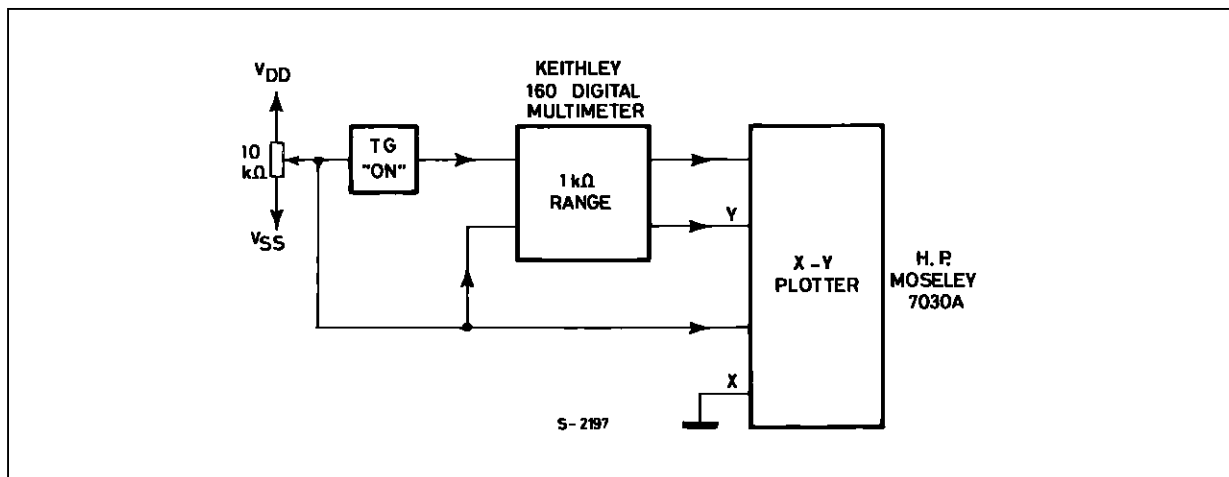

Propagation Delay Waveform Channel Being Turned ON ($R_L = 10\text{ K}\Omega$, $C_L = 50\text{ pF}$)

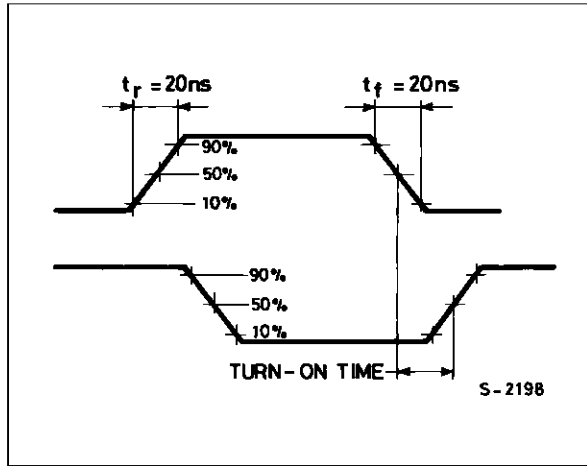

Propagation Delay Waveform Channel Being Turned OFF ($R_L = 300\ \Omega$, $C_L = 50\text{ pF}$)

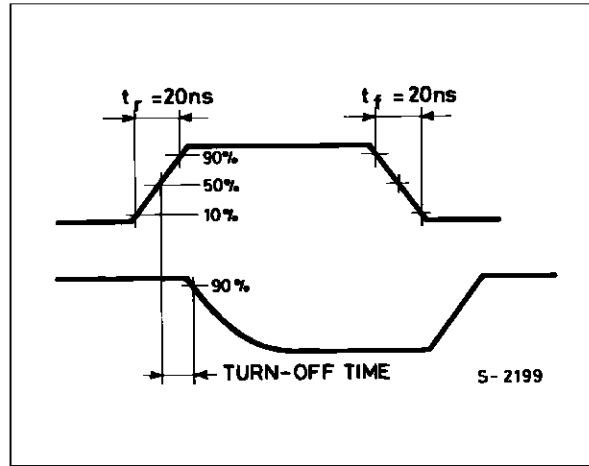

APPLICATIONS INFORMATION

In applications where separate power sources are used to drive V_{DD} and the signal inputs, the V_{DD} current capability should exceed V_{DD}/R_L ($R_L =$ effective external load). This provision avoids permanent current flow or clamp action on the V_{DD} supply when power is applied or removed from the **HCC/HCF4067B** or **HCC/HCF4097B**.

When switching from one address to another, some of the ON periods of the channels of the multiplexers will overlap momentarily, which may be objectionable in certain applications. Also when a channel is turned ON or OFF by an address input, there is a momentary conductive path from the channel to V_{SS} , which will dump some charge from any capacitor connected to the input or output of the channel. The inhibit input turning on a channel will similarly dump some charge to V_{SS} .

The amount of charge dumped is mostly a function of the signal level above V_{SS} . Typically, at $V_{DD} - V_{SS} = 10\text{V}$, a 100 pF capacitor connected to the input or output of the channel will

lose 3-4% of its voltage at the moment the channel turns ON or OFF. This loss of voltage is essentially independent of the address or inhibit signal transition time, if the transition time is less than 1-2 μs . When the inhibit signal turns a channel off, there is no charge dumping of V_{SS} . Rather, there is a slight rise in the channel voltage level (65 mV typ.) due to the capacitance coupling from inhibit input to channel input or output. Address input also couples some voltage steps onto the channel signal levels.

In certain applications, the external load-resistor current may include both V_{DD} and signal line components. To avoid drawing V_{DD} current when switch current flows into the transmission gate inputs, the voltage drop across the bidirectional switch must not exceed 0.8 V (calculated from R_{ON} values shown in ELECTRICAL CHARACTERISTICS CHART). No V_{DD} current will flow through R_L if the switch current flows into terminal 1 on the **HCC/HCF4067B**, terminals 1 and 17 on the **HCC/HCF4097B**.

Plastic DIP24 (0.25) MECHANICAL DATA

DIM.	mm			inch		
	MIN.	TYP.	MAX.	MIN.	TYP.	MAX.
a1		0.63			0.025	
b		0.45			0.018	
b1	0.23		0.31	0.009		0.012
b2		1.27			0.050	
D			32.2			1.268
E	15.2		16.68	0.598		0.657
e		2.54			0.100	
e3		27.94			1.100	
F			14.1			0.555
l		4.445			0.175	
L		3.3			0.130	

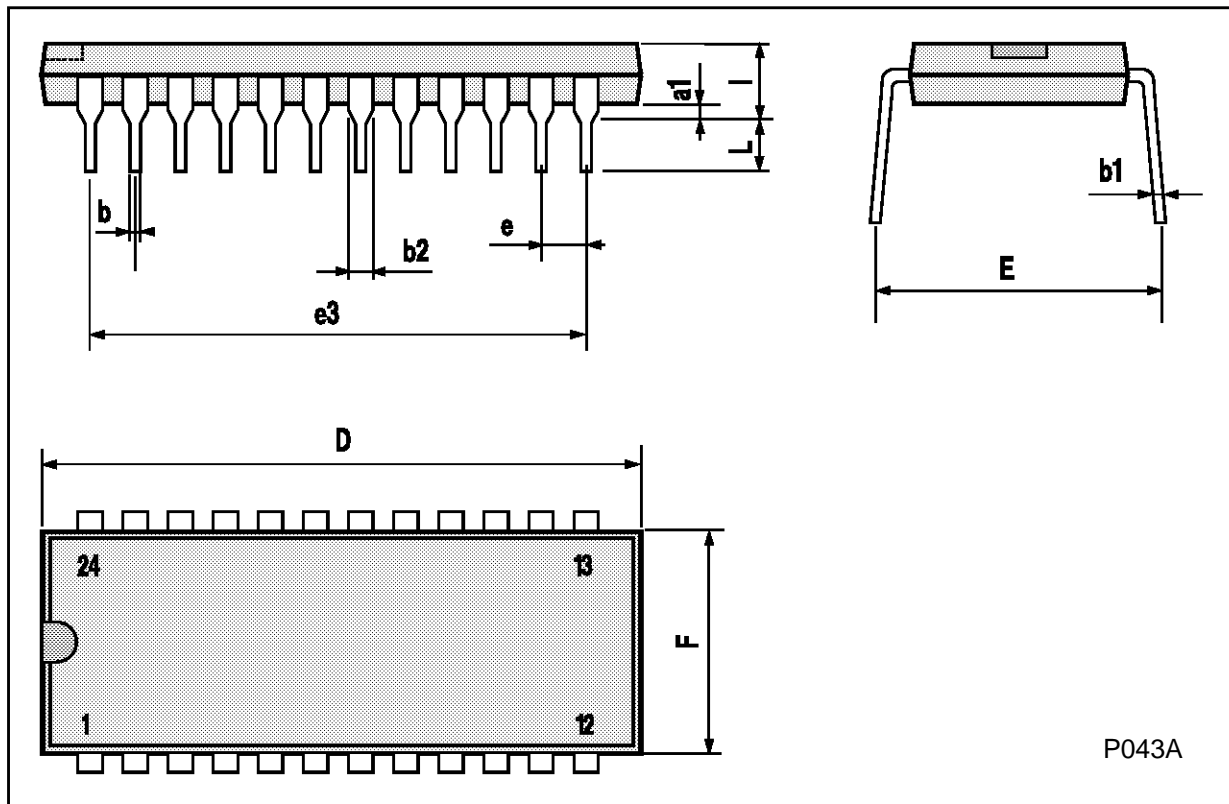

Ceramic DIP24 MECHANICAL DATA

DIM.	mm			inch		
	MIN.	TYP.	MAX.	MIN.	TYP.	MAX.
A			32.3			1.272
B	13.05		13.36	0.514		0.526
C	3.9		5.08	0.154		0.200
D	3			0.118		
E	0.5		1.78	0.020		0.070
e3		27.94			1.100	
F	2.29		2.79	0.090		0.110
G	0.4		0.55	0.016		0.022
I	1.17		1.52	0.046		0.060
L	0.22		0.31	0.009		0.012
M	1.52		2.49	0.060		0.098
N1	4° (min.), 15° (max.)					
P	15.4		15.8	0.606		0.622
Q			5.71			0.225

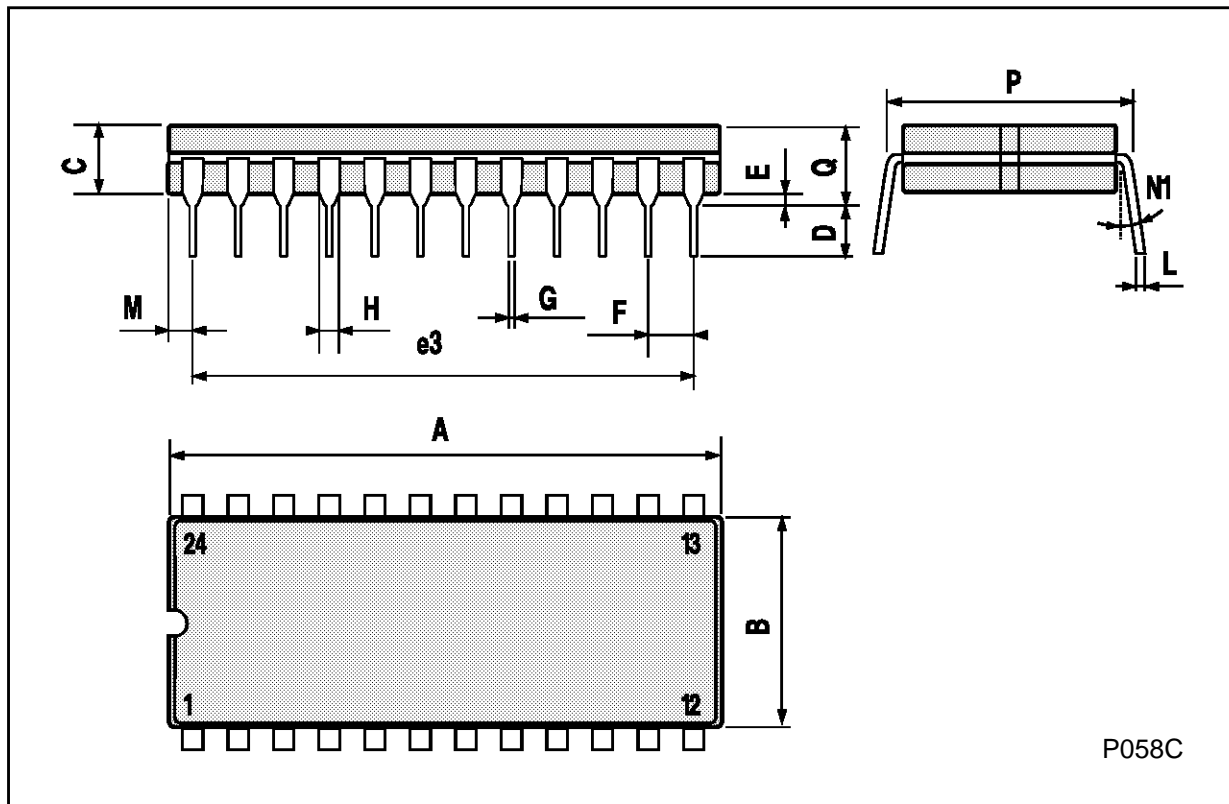

P058C

SO24 MECHANICAL DATA

DIM.	mm			inch		
	MIN.	TYP.	MAX.	MIN.	TYP.	MAX.
A			2.65			0.104
a1	0.10		0.20	0.004		0.007
a2			2.45			0.096
b	0.35		0.49	0.013		0.019
b1	0.23		0.32	0.009		0.012
C		0.50			0.020	
c1	45° (typ.)					
D	15.20		15.60	0.598		0.614
E	10.00		10.65	0.393		0.420
e		1.27			0.05	
e3		13.97			0.55	
F	7.40		7.60	0.291		0.299
L	0.50		1.27	0.19		0.050
S	8° (max.)					

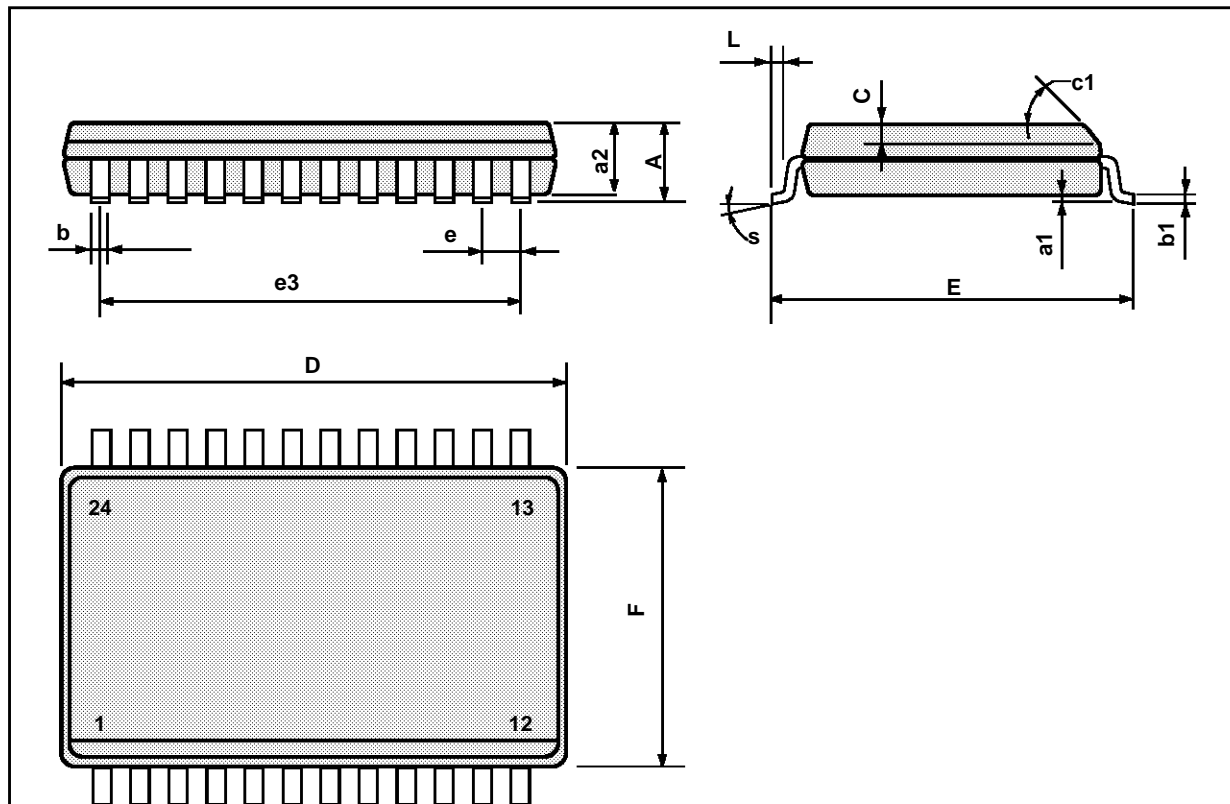

PLCC20 MECHANICAL DATA

DIM.	mm			inch		
	MIN.	TYP.	MAX.	MIN.	TYP.	MAX.
A	9.78		10.03	0.385		0.395
B	8.89		9.04	0.350		0.356
D	4.2		4.57	0.165		0.180
d1		2.54			0.100	
d2		0.56			0.022	
E	7.37		8.38	0.290		0.330
e		1.27			0.050	
e3		5.08			0.200	
F		0.38			0.015	
G			0.101			0.004
M		1.27			0.050	
M1		1.14			0.045	

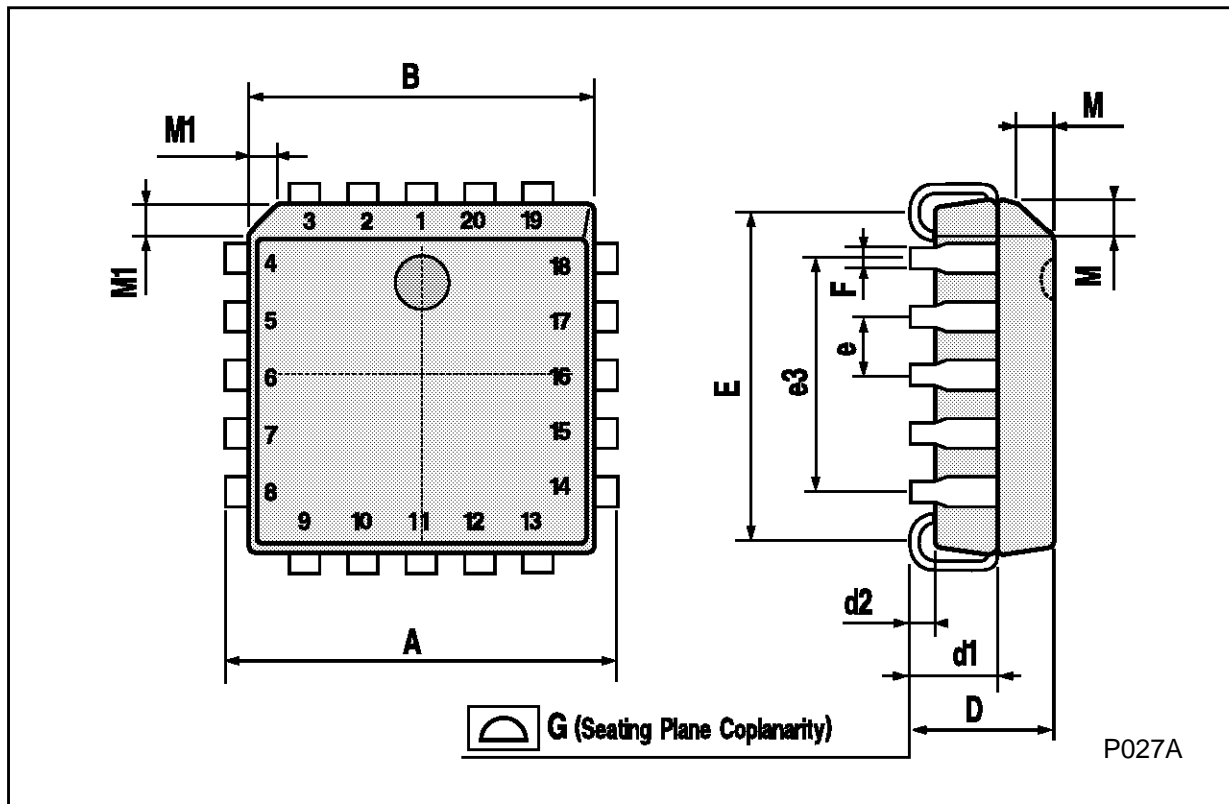

Information furnished is believed to be accurate and reliable. However, SGS-THOMSON Microelectronics assumes no responsibility for the consequences of use of such information nor for any infringement of patents or other rights of third parties which may result from its use. No license is granted by implication or otherwise under any patent or patent rights of SGS-THOMSON Microelectronics. Specifications mentioned in this publication are subject to change without notice. This publication supersedes and replaces all information previously supplied. SGS-THOMSON Microelectronics products are not authorized for use as critical components in life support devices or systems without express written approval of SGS-THOMSON Microelectronics.

© 1994 SGS-THOMSON Microelectronics - All Rights Reserved

SGS-THOMSON Microelectronics GROUP OF COMPANIES

Australia - Brazil - France - Germany - Hong Kong - Italy - Japan - Korea - Malaysia - Malta - Morocco - The Netherlands -
Singapore - Spain - Sweden - Switzerland - Taiwan - Thailand - United Kingdom - U.S.A