

54ACTQ16646

54ACTQ16646 16-Bit Transceiver/Register with TRI-STATE Outputs



Literature Number: SNOS590

54ACTQ16646 16-Bit Transceiver/Register with TRI-STATE® Outputs

General Description

The 'ACTQ16646 contains sixteen non-inverting bidirectional registered bus transceivers providing multiplexed transmission of data directly from the input bus or from the internal storage registers. Each byte has separate control inputs which can be shorted together for full 16-bit operation. The DIR inputs determine the direction of data flow through the device. The CPAB and CPBA inputs load data into the registers on the LOW-to-HIGH transition. The 'ACTQ16646 utilizes NSC Quiet Series technology to guarantee quiet output switching and improved dynamic threshold performance. FACT Quiet Series® features GTO® output control and undershoot corrector for superior performance.

Features

- Utilizes NSC FACT Quiet Series technology
- Guaranteed simultaneous switching noise level and dynamic threshold performance
- Independent registers for A and B buses
- Multiplexed real-time and stored data transfers
- Separate control logic for each byte
- 16-bit version of the 'ACTQ646
- Outputs source/sink 24 mA
- Standard Microcircuit Drawing (SMD) 5962-9581601

Logic Symbol

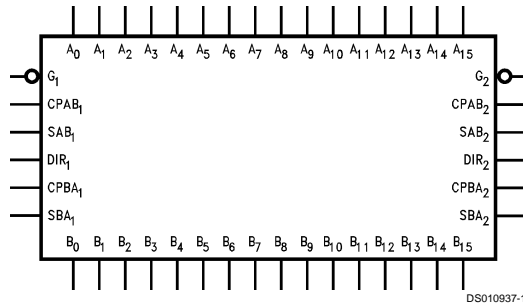

GTO™ is a trademark of National Semiconductor Corporation.
TRI-STATE® is a registered trademark of National Semiconductor Corporation.
FACT™ and FACT Quiet Series™ are trademarks of Fairchild Semiconductor Corporation.

Connection Diagram

Pin Assignment for CERPAK

DIR ₁	1	56	\bar{G}_1
CPAB ₁	2	55	CPBA ₁
SAB ₁	3	54	SBA ₁
GND	4	53	GND
A ₀	5	52	B ₀
A ₁	6	51	B ₁
V _{CC}	7	50	V _{CC}
A ₂	8	49	B ₂
A ₃	9	48	B ₃
A ₄	10	47	B ₄
GND	11	46	GND
A ₅	12	45	B ₅
A ₆	13	44	B ₆
A ₇	14	43	B ₇
A ₈	15	42	B ₈
A ₉	16	41	B ₉
A ₁₀	17	40	B ₁₀
GND	18	39	GND
A ₁₁	19	38	B ₁₁
A ₁₂	20	37	B ₁₂
A ₁₃	21	36	B ₁₃
V _{CC}	22	35	V _{CC}
A ₁₄	23	34	B ₁₄
A ₁₅	24	33	B ₁₅
GND	25	32	GND
SAB ₂	26	31	SBA ₂
CPAB ₂	27	30	CPBA ₂
DIR ₂	28	29	\bar{G}_2

DS010937-2

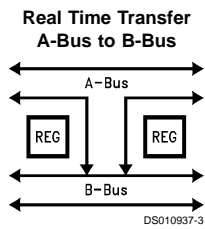

FIGURE 1.

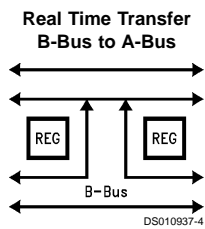

FIGURE 2.

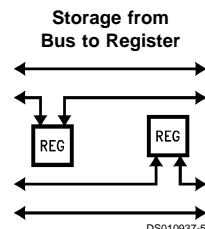

FIGURE 3.

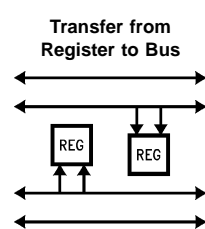

FIGURE 4.

Function Table

Inputs						Data I/O (Note 1)		Output Operation Mode
G ₁	DIR ₁	CPAB ₁	CPBA ₁	SAB ₁	SBA ₁	A ₀₋₇	B ₀₋₇	
H	X	H or L	H or L	X	X	Input	Input	Isolation
H	X	N	X	X	X			Clock An Data into A Register
H	X	X	N	X	X			Clock Bn Data Into B Register
L	H	X	X	L	X	Input	Output	An to Bn— Real Time (Transparent Mode)
L	H	N	X	L	X			Clock An Data to A Register
L	H	H or L	X	H	X			A Register to Bn (Stored Mode)
L	H	N	X	H	X			Clock An Data into A Register and Output to Bn
L	L	X	X	X	L	Output	Input	Bn to An— Real Time (Transparent Mode)
L	L	X	N	X	L			Clock Bn Data into B Register
L	L	X	H or L	X	H			B Register to An (Stored Mode)
L	L	X	N	X	H			Clock Bn into B Register and Output to An

H = HIGH Voltage Level X = Immaterial
L = LOW Voltage Level N = LOW-to-HIGH Transition.

Note 1: The data output functions may be enabled or disabled by various signals at the G and DIR inputs. Data input functions are always enabled; i.e., data at the bus pins will be stored on every LOW-to-HIGH transition of the appropriate clock inputs. Also applies to data I/O (A and B: 8-15) and #2 control pins.

Logic Diagram

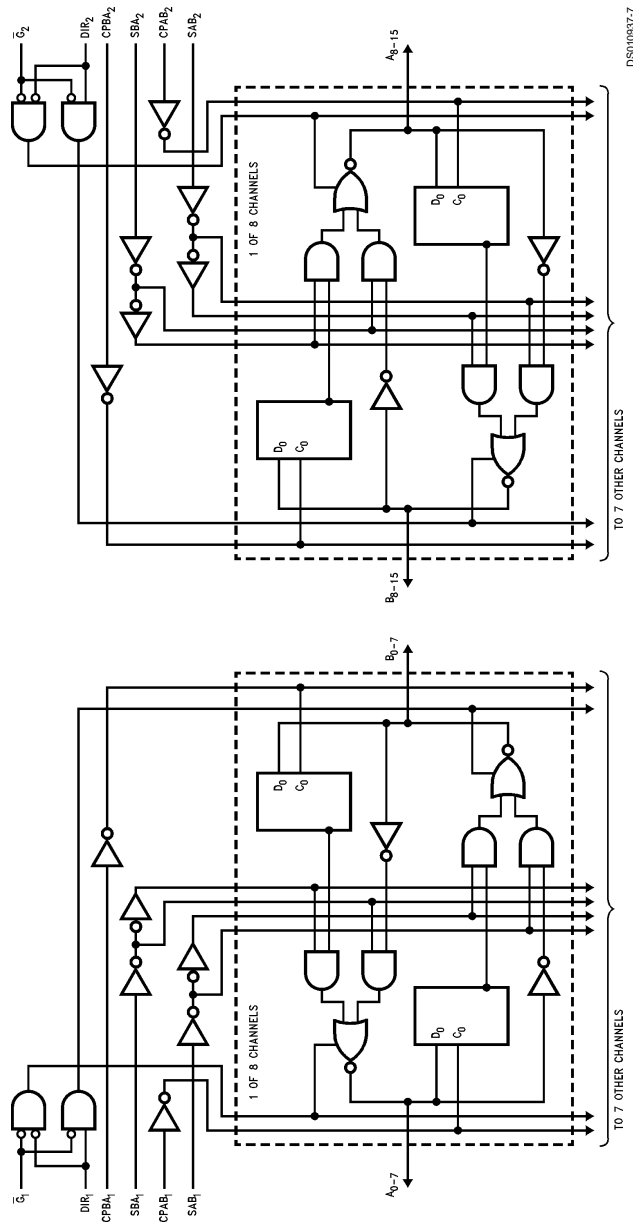

DS010897-7

Absolute Maximum Ratings (Note 2)

If Military/Aerospace specified devices are required, please contact the National Semiconductor Sales Office/Distributors for availability and specifications.

Supply Voltage (V_{CC})	-0.5V to +7.0V
DC Input Diode Current (I_{IK})	
$V_I = -0.5V$	-20 mA
$V_I = V_{CC} + 0.5V$	+20 mA
DC Output Diode Current (I_{OK})	
$V_O = -0.5V$	-20 mA
$V_O = V_{CC} + 0.5V$	+20 mA
DC Output Voltage (V_O)	-0.5V to $V_{CC} + 0.5V$
DC Output Source/Sink Current (I_O)	±50 mA
DC V_{CC} or Ground Current per Output Pin	±50 mA
Junction Temperature CDIP	+175°C
Storage Temperature	-65°C to +150°C

Recommended Operating Conditions

Supply Voltage (V_{CC}) 'ACTQ	4.5V to 5.5V
Input Voltage (V_I)	0V to V_{CC}
Output Voltage (V_O)	0V to V_{CC}
Operating Temperature (T_A): 54ACTQ	-55°C to +125°C
Minimum Input Edge Rate (dV/dt) 'ACTQ Devices	125 mV/ns
V_{IN} from 0.8V to 2.0V	
V_{CC} @ 4.5V, 5.5V	

Note 2: Absolute maximum ratings are those values beyond which damage to the device may occur. The databook specifications should be met, without exception to ensure that the system design is reliable over its power supply, temperature, and output/input loading variables. National does not recommend operation of FACT™ circuits outside databook specifications.

DC Electrical Characteristics for 'ACTQ Family Devices

Symbol	Parameter	V_{CC} (V)	54ACTQ	Units	Conditions
			$T_A = -55^\circ\text{C to } +125^\circ\text{C}$		
			Guaranteed Limits		
V_{IH}	Minimum High Input Voltage	4.5	2.0	V	$V_{OUT} = 0.1V$ or $V_{CC} - 0.1V$
		5.5	2.0		
V_{IL}	Maximum Low Input Voltage	4.5	0.8	V	$V_{OUT} = 0.1V$ or $V_{CC} - 0.1V$
		5.5	0.8		
V_{OH}	Minimum High Output Voltage	4.5	4.4	V	$I_{OUT} = -50 \mu A$
		5.5	5.4		
		4.5	3.70	V	$V_{IN} = V_{IL}$ or V_{IH} $I_{OH} = -24 \text{ mA}$ $I_{OH} = -24 \text{ mA}$
		5.5	4.70		
V_{OL}	Maximum Low Output Voltage	4.5	0.1	V	$I_{OUT} = 50 \mu A$
		5.5	0.1		
		4.5	0.50	V	$V_{IN} = V_{IL}$ or V_{IH} $I_{OL} = 24 \text{ mA}$ $I_{OL} = 24 \text{ mA}$
		5.5	0.50		
I_{OZT}	Maximum I/O Leakage Current	5.5	±10.0	µA	$V_{IN} = V_{IL}, V_{IH}$ $V_O = V_{CC}, \text{GND}$
I_{IN}	Maximum Input Leakage Current	5.5	±1.0	µA	$V_I = V_{CC}, \text{GND}$
I_{CCT}	Maximum I_{CC} /Input	5.5	1.6	mA	$V_I = V_{CC} - 2.1V$
I_{CC}	Max Quiescent Supply Current	5.5	160.0	µA	$V_{IN} = V_{CC}$ or GND
I_{OLD}	Minimum Dynamic Output Current (Note 4)	5.5	50	mA	$V_{OLD} = 1.65V$ Max
I_{OHD}	Output Current (Note 4)		50	mA	$V_{OHD} = 3.85V$ Min
V_{OLP}	Quick Output Maximum Dynamic V_{OL}	5.0	1.1	V	(Notes 5, 6)
V_{OLV}	Quick Output Minimum Dynamic V_{OL}	5.0	-0.8	V	(Notes 5, 6)

Note 3: All outputs loaded; thresholds associated with output under test.

Note 4: Maximum test duration 2.0 ms; one output loaded at a time.

Note 5: Maximum number of outputs that can switch simultaneously is n. (n - 1) outputs are switched LOW and one output held LOW.

DC Electrical Characteristics for 'ACTQ Family Devices (Continued)

Note 6: Maximum number of outputs that can switch simultaneously is n. (n – 1) outputs are switched HIGH and one output held HIGH.

AC Electrical Characteristics

Symbol	Parameter	V _{CC} (V) (Note 7)	54ACTQ		Units
			T _A = -55°C to +125°C C _L = 50 pF		
			Min	Max	
t _{PHL} t _{PLH}	Propagation Delay Clock to Bus	5.0	2.9 3.2	10.2 10.2	ns
t _{PHL} t _{PLH}	Propagation Delay Bus to Bus	5.0	3.6 3.3	11.5 10.8	ns
t _{PHL} t _{PLH}	Propagation Delay Select to Bus (w/An or Bn HIGH or LOW)	5.0	3.1 3.2	11.3 11.5	ns
t _{PZL} t _{PZH}	Enable Time G to An/Bn	5.0	3.8 3.3	12.9 11.9	ns
t _{PLZ} t _{PHZ}	Disable Time G to An/Bn	5.0	2.3 2.6	9.8 9.5	ns
t _{PZL} t _{PZH}	Enable Time DIR to An/Bn	5.0	4.3 3.7	14.0 12.8	ns
t _{PLZ} t _{PHZ}	Disable Time DIR to An/Bn	5.0	2.0 2.5	10.8 11.0	ns

Note 7: Voltage Range 5.0 is 5.0V ±0.5V.

AC Operating Requirements

Symbol	Parameter	V _{CC} (V) (Note 8)	54ACTQ		Units
			T _A = -55°C to +125°C C _L = 50 pF		
			Guaranteed Minimum		
t _S	Setup Time, H or L Bus to Clock	5.0	3.0		ns
t _H	Hold Time, H or L Bus to Clock	5.0	1.5		ns
t _W	Clock Pulse Width H or L	5.0	4.0		ns

Note 8: Voltage Range 5.0 is 5.0V ±0.5V.

Capacitance

Symbol	Parameter	Typ	Units	Conditions
C _{IN}	Input Capacitance	4.5	pF	V _{CC} = 5.0V
C _{PD}	Power Dissipation Capacitance	95	pF	V _{CC} = 5.0V



Physical Dimensions inches (millimeters) unless otherwise noted

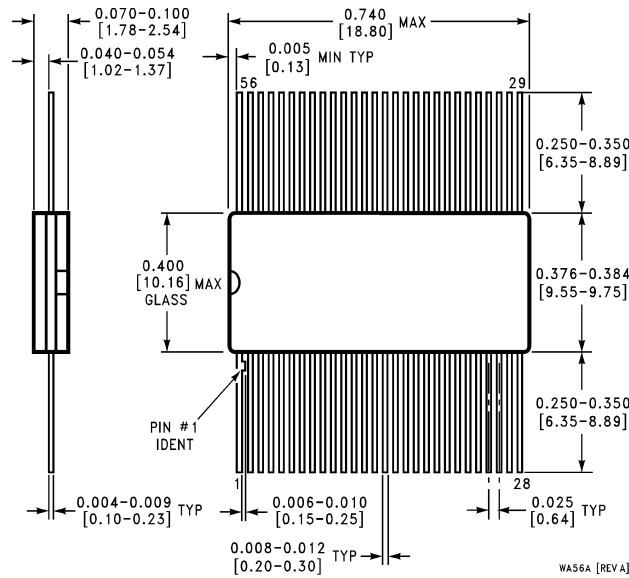

**56-Lead CERPAK
NS Package Number WA56A**

LIFE SUPPORT POLICY

NATIONAL'S PRODUCTS ARE NOT AUTHORIZED FOR USE AS CRITICAL COMPONENTS IN LIFE SUPPORT DEVICES OR SYSTEMS WITHOUT THE EXPRESS WRITTEN APPROVAL OF THE PRESIDENT OF NATIONAL SEMICONDUCTOR CORPORATION. As used herein:

1. Life support devices or systems are devices or systems which, (a) are intended for surgical implant into the body, or (b) support or sustain life, and whose failure to perform when properly used in accordance with instructions for use provided in the labeling, can be reasonably expected to result in a significant injury to the user.
2. A critical component in any component of a life support device or system whose failure to perform can be reasonably expected to cause the failure of the life support device or system, or to affect its safety or effectiveness.



National Semiconductor Corporation
Americas
Tel: 1-800-272-9959
Fax: 1-800-737-7018
Email: support@nsc.com

National Semiconductor Europe
Fax: +49 (0) 1 80-530 85 86
Email: europe.support@nsc.com
Deutsch Tel: +49 (0) 1 80-530 85 85
English Tel: +49 (0) 1 80-532 78 32
Français Tel: +49 (0) 1 80-532 93 58
Italiano Tel: +49 (0) 1 80-534 16 80

National Semiconductor Asia Pacific Customer Response Group
Tel: 65-2544466
Fax: 65-2504466
Email: sea.support@nsc.com

National Semiconductor Japan Ltd.
Tel: 81-3-5620-6175
Fax: 81-3-5620-6179

www.national.com

IMPORTANT NOTICE

Texas Instruments Incorporated and its subsidiaries (TI) reserve the right to make corrections, modifications, enhancements, improvements, and other changes to its products and services at any time and to discontinue any product or service without notice. Customers should obtain the latest relevant information before placing orders and should verify that such information is current and complete. All products are sold subject to TI's terms and conditions of sale supplied at the time of order acknowledgment.

TI warrants performance of its hardware products to the specifications applicable at the time of sale in accordance with TI's standard warranty. Testing and other quality control techniques are used to the extent TI deems necessary to support this warranty. Except where mandated by government requirements, testing of all parameters of each product is not necessarily performed.

TI assumes no liability for applications assistance or customer product design. Customers are responsible for their products and applications using TI components. To minimize the risks associated with customer products and applications, customers should provide adequate design and operating safeguards.

TI does not warrant or represent that any license, either express or implied, is granted under any TI patent right, copyright, mask work right, or other TI intellectual property right relating to any combination, machine, or process in which TI products or services are used. Information published by TI regarding third-party products or services does not constitute a license from TI to use such products or services or a warranty or endorsement thereof. Use of such information may require a license from a third party under the patents or other intellectual property of the third party, or a license from TI under the patents or other intellectual property of TI.

Reproduction of TI information in TI data books or data sheets is permissible only if reproduction is without alteration and is accompanied by all associated warranties, conditions, limitations, and notices. Reproduction of this information with alteration is an unfair and deceptive business practice. TI is not responsible or liable for such altered documentation. Information of third parties may be subject to additional restrictions.

Resale of TI products or services with statements different from or beyond the parameters stated by TI for that product or service voids all express and any implied warranties for the associated TI product or service and is an unfair and deceptive business practice. TI is not responsible or liable for any such statements.

TI products are not authorized for use in safety-critical applications (such as life support) where a failure of the TI product would reasonably be expected to cause severe personal injury or death, unless officers of the parties have executed an agreement specifically governing such use. Buyers represent that they have all necessary expertise in the safety and regulatory ramifications of their applications, and acknowledge and agree that they are solely responsible for all legal, regulatory and safety-related requirements concerning their products and any use of TI products in such safety-critical applications, notwithstanding any applications-related information or support that may be provided by TI. Further, Buyers must fully indemnify TI and its representatives against any damages arising out of the use of TI products in such safety-critical applications.

TI products are neither designed nor intended for use in military/aerospace applications or environments unless the TI products are specifically designated by TI as military-grade or "enhanced plastic." Only products designated by TI as military-grade meet military specifications. Buyers acknowledge and agree that any such use of TI products which TI has not designated as military-grade is solely at the Buyer's risk, and that they are solely responsible for compliance with all legal and regulatory requirements in connection with such use.

TI products are neither designed nor intended for use in automotive applications or environments unless the specific TI products are designated by TI as compliant with ISO/TS 16949 requirements. Buyers acknowledge and agree that, if they use any non-designated products in automotive applications, TI will not be responsible for any failure to meet such requirements.

Following are URLs where you can obtain information on other Texas Instruments products and application solutions:

Products

Audio	www.ti.com/audio
Amplifiers	amplifier.ti.com
Data Converters	dataconverter.ti.com
DLP® Products	www.dlp.com
DSP	dsp.ti.com
Clocks and Timers	www.ti.com/clocks
Interface	interface.ti.com
Logic	logic.ti.com
Power Mgmt	power.ti.com
Microcontrollers	microcontroller.ti.com
RFID	www.ti-rfid.com
OMAP Mobile Processors	www.ti.com/omap
Wireless Connectivity	www.ti.com/wirelessconnectivity

Applications

Communications and Telecom	www.ti.com/communications
Computers and Peripherals	www.ti.com/computers
Consumer Electronics	www.ti.com/consumer-apps
Energy and Lighting	www.ti.com/energy
Industrial	www.ti.com/industrial
Medical	www.ti.com/medical
Security	www.ti.com/security
Space, Avionics and Defense	www.ti.com/space-avionics-defense
Transportation and Automotive	www.ti.com/automotive
Video and Imaging	www.ti.com/video

TI E2E Community Home Page

e2e.ti.com

Mailing Address: Texas Instruments, Post Office Box 655303, Dallas, Texas 75265
Copyright © 2011, Texas Instruments Incorporated