

FEATURES

- 4–20 mA, 0–20 mA Output Ranges**
- Pre-calibrated Input Ranges:**
0 V to 2 V, 0 V to 10 V
- Precision Voltage Reference**
Programmable to 2.000 V or 10.000 V
- Single or Dual Supply Operation**
- Wide Power Supply Range: +4.5 V to +36 V**
- Wide Output Compliance**
- Input Buffer Amplifier**
- Open-Loop Alarm**
- Optional External Pass Transistor to Reduce Self-Heating Errors**
- 0.002% typ Nonlinearity**

PRODUCT DESCRIPTION

The AD694 is a monolithic current transmitter that accepts high level signal inputs to drive a standard 4–20 mA current loop for the control of valves, actuators, and other devices commonly used in process control. The input signal is buffered by an input amplifier that can be used to scale the input signal or buffer the output from a current mode DAC. Pre-calibrated input spans of 0 V to 2 V and 0 V to 10 V are selected by simple pin strapping; other spans may be programmed with external resistor.

The output stage compliance extends to within 2 V of V_S and its special design allows the output voltage to extend below common in dual supply operation. An alarm warns of an open 4-to-20 mA loop or noncompliance of the output stage.

Active laser trimming of the AD694's thin film resistors results in high levels of accuracy without the need for additional adjustments and calibration. An external pass transistor may be used with the AD694 to off-load power dissipation, extending the temperature range of operation.

The AD694 is the ideal building block for systems requiring noise immune 4–20 mA signal transmission to operate valves, actuators, and other control devices, as well as for the transmission of process parameters such as pressure, temperature, or flow. It is recommended as a replacement for discrete designs in a variety of applications in industrial process control, factory automation, and system monitoring.

The AD694 is available in hermetically sealed, 16-pin cerdip and plastic SOIC, specified over the -40°C to $+85^{\circ}\text{C}$ industrial temperature range, and in a 16-pin plastic DIP, specified over the 0°C to $+70^{\circ}\text{C}$ temperature range.

*Protected by U.S. Patents: 30,586; 4,250,445; 4,857,862.

REV. A

Information furnished by Analog Devices is believed to be accurate and reliable. However, no responsibility is assumed by Analog Devices for its use, nor for any infringements of patents or other rights of third parties which may result from its use. No license is granted by implication or otherwise under any patent or patent rights of Analog Devices.

FUNCTIONAL BLOCK DIAGRAM

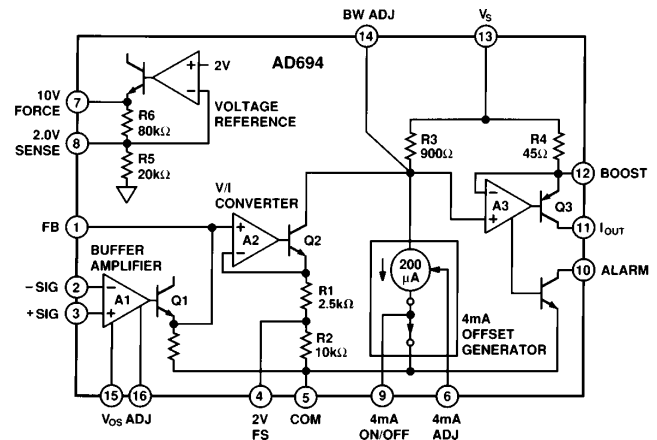

PRODUCT HIGHLIGHTS

1. The AD694 is a complete voltage in to 4–20 mA out current transmitter.
2. Pin programmable input ranges are pre-calibrated at 0 V to 2 V and 0 V to 10 V.
3. The input amplifier may be configured to buffer and scale the input voltage, or to serve as an output amplifier for current output DACs.
4. The output voltage compliance extends to within 2 V of the positive supply and below common. When operated with a 5 V supply, the output voltage compliance extends 30 V below common.
5. The AD694 interfaces directly to 8-, 10-, and 12-bit single supply CMOS and bipolar DACs.
6. The 4 mA zero current may be switched on and off with a TTL control pin, allowing 0–20 mA operation.
7. An open collector alarm warns of loop failure due to open wires or noncompliance of the output stage.
8. A monitored output is provided to drive an external pass transistor. The feature off-loads power dissipation to extend the temperature range of operation and minimize self-heating error.

AD694—SPECIFICATIONS

(@ +25°C, $R_L = 250\ \Omega$ and $V_S = +24\ \text{V}$, unless otherwise noted)

Model	AD694JN/AQ/AR			AD694BQ/BR			Units
	Min	Typ	Max	Min	Typ	Max	
INPUT CHARACTERISTICS							
Input Voltage Range	-0.2	$V_S - 2.0\ \text{V}$	$V_S - 2.5\ \text{V}$	-0.2	$V_S - 2.0\ \text{V}$	$V_S - 2.5\ \text{V}$	V
Input Bias Current							
Either Input, T_{MIN} to T_{MAX}		1.5	5		1.5	5	nA
Offset Current, T_{MIN} to T_{MAX}		± 0.1	± 1		± 0.1	± 1	nA
Offset Current Drift		± 1.0	± 5.0		± 1.0	± 5.0	pA/°C
Input Impedance	5			5			M Ω
OUTPUT CHARACTERISTICS							
Operating Current Range	0		23	0		23	mA
Specified Performance	4		20	4		20	mA
Output Voltage Compliance	$V_S - 36\ \text{V}$		$V_S - 2\ \text{V}$	$V_S - 36\ \text{V}$		$V_S - 2\ \text{V}$	V
Output Impedance, 4–20 mA	40.0	50.0		40.0	50.0		M Ω
Current Limit (@ $2 \times$ FS Overdrive)	24		44	24		44	mA
Slew Rate		1.3			1.3		mA/ μs
SPAN AND ZERO ACCURACY¹							
4 mA Offset Error @ 0 V Input ²							
Error from 4.000 mA, 4 mA On		± 10	± 20		± 5	± 10	μA
Error from 0.000 mA, 4 mA Off	0	+10	+20	0	+5	+10	μA
T_{MIN} to T_{MAX}		± 10	± 40		± 5	± 20	μA
vs. Supply (2 V Span/10 V Span)		0.3/0.05	0.8/0.4		0.3/0.05	0.8/0.4	$\mu\text{A}/\text{V}$
Trim Range, 4 mA Zero	2.0		4.8	2.0		4.8	mA
Span							
Nominal Transfer Function							
Input FS = 2 V		8.0			8.0		mA/V
Input FS = 10 V		1.6			1.6		mA/V
Transfer Function Error from Nom,							
Input FS = 2 V, 10 V		± 0.1	± 0.3		± 0.05	± 0.15	% of Span
T_{MIN} to T_{MAX}		± 0.002	± 0.005		± 0.001	± 0.0025	% of Span/°C
vs. Supply		± 0.001	± 0.005		± 0.001	± 0.005	% of Span/V
Nonlinearity ³		± 0.005	± 0.015		± 0.001	± 0.005	% of Span
4 mA On: Max Pin 9 Voltage			0.8			0.8	V
4 mA Off: Min Pin 9 Voltage	3.0	2.5		3.0	2.5		V
VOLTAGE REFERENCE							
Output Voltage: 10 V Reference	9.960	10.000	10.040	9.980	10.000	10.020	V
Output Voltage: 2 V Reference	1.992	2.000	2.008	1.996	2.000	2.004	V
T_{MIN} to T_{MAX} ⁴		30	50		20	30	ppm/°C
vs. Load, $V_{\text{REF}} = 2\ \text{V}$, 10 V		0.15	0.50		0.15	0.50	mV/mA
vs. Supply, $V_{\text{REF}} = 2\ \text{V}$, 10 V		± 0.001	± 0.005		± 0.001	± 0.005	%/V
Output Current							
Source	5			5			mA
Sink		0.2			0.2		mA
ALARM CHARACTERISTICS							
$V_{\text{CE(SAT)}}$ @ 2.5 mA		0.35			0.35		V
Leakage Current			± 1			± 1	μA
Alarm Pin Current (Pin 10)		20			20		mA
POWER REQUIREMENTS							
Specified Performance		24			24		V
Operating Range							
2 V FS, $V_{\text{REF}} = 2\ \text{V}$	4.5		36	4.5		36	V
2 V, 10 V FS, $V_{\text{REF}} = 2\ \text{V}$, 10 V	12.5		36	12.5		36	V
Quiescent Current, 4 mA Off		1.5	2.0		1.5	2.0	mA
TEMPERATURE RANGE							
Specified Performance ⁵ AD694AQ/BQ/AR/BR	-40		+85	-40		+85	°C
AD694JN	0		+70	0		+70	°C
Operating AD694AQ/BQ/AR/BR	-55		+125	-55		+125	°C
AD694JN	-40		+85	-40		+85	°C

Model	AD694JN/AQ/AR			AD694BQ/BR			Units
	Min	Typ	Max	Min	Typ	Max	
BUFFER AMPLIFIER⁶							
Input Offset Voltage							
Initial Offset		±150	±500		±50	±500	μV
T _{MIN} to T _{MAX}		±2	±3		±2	±3	μV/°C
vs. Supply	80	90		80	90		dB
vs. Common Mode	80	90		80	90		dB
Trim Range	±2.5	±4.0		±2.5	±4.0		mV
Frequency Response							
Unity Gain, Small Signal		300			300		kHz
Input Voltage Noise (0.1 Hz to 10 Hz)		2			2		μV p-p
Open-Loop Gain							
V _O = +10 V, R _L ≥ 10 kΩ		50			50		V/mV
Output Voltage @ Pin 1, FB ¹							
Minimum Output Voltage		1.0	10		1.0	10	mV
Maximum Output Voltage	V _S -2.5 V	V _S -2 V		V _S -2.5 V	V _S -2 V		V

NOTES

¹The single supply op amps of the AD694, lacking pull down current, may not reach 0.000 V at their outputs. For this reason, span, offset, and nonlinearity are specified with the input amplifiers operating in their linear range. The input voltage used for the tests is 5 mV to 2 V and 5 mV to 10 V for the two precalibrated input ranges. Span and zero accuracy are tested with the buffer amplifier configured as a follower.

²Offset at 4 mA out and 0 mA out are extrapolated to 0.000 V input from measurements made at 5 mV and at full scale. See Note 1.

³Nonlinearity is specified as the maximum deviation of the output, as a % of span, from a straight line drawn through the endpoints of the transfer function.

⁴Voltage reference drift guaranteed by the Box Method. The voltage reference output over temperature will fall inside of a box whose length is determined by the temperature range and whose height is determined by the maximum temperature coefficient multiplied by the temperature span in degrees C.

⁵Devices tested at these temperatures with a pass transistor. Allowable temperature range of operation is dependent upon internal power dissipation. Absolute maximum junction and case temperature should not be exceeded. See section: "Power Dissipation Considerations."

⁶Buffer amplifier specs for reference. Buffer amplifier offset and drift already included in Span and Zero accuracy specs above.

Specifications subject to change without notice.

ABSOLUTE MAXIMUM RATINGS

Supply Voltage	+36 V
V _S to I _{OUT}	+36 V
Input Voltage, (Either Input Pin 2 or 3)	-0.3 V to +36 V
Reference Short Circuit to Common	Indefinite
Alarm Voltage, Pin 10	+36 V
4 mA Adj, Pin 6	+1 V
4 mA On/Off, Pin 9	0 V to 36 V
Storage Temperature Range	
AD694Q	-65°C to +150°C
AD694N, R	-65°C to +125°C
Lead Temperature, 10 sec Soldering	+300°C
Maximum Junction Temperature	+150°C
Maximum Case Temperature	
Plastic Package (N, R)	+125°C
Cerdip Package (Q)	+125°C

Transistor Count:75 Active Devices
 Substrate Connection: to Com, Pin 5

Thermal Characteristics:

Plastic (N) Package:	θ _{JC} = 50°C/Watt
	θ _{CA} (Still Air) = 85°C/Watt
Cerdip (Q) Package:	θ _{JC} = 30°C/Watt
	θ _{CA} (Still Air) = 70°C/Watt
Plastic (R) Package:	θ _{JC} = 27°C/Watt
	θ _{CA} (Still Air) = 73°C/Watt

ESD Susceptibility

All pins are rated for a minimum of 4000 V protection, except for Pins 2, 3 and 9 which are rated to survive a minimum of 1500 V. ESD testing conforms to Human Body Model. Always practice ESD prevention.

No pin, other than I_{OUT} (11) and ±Sig (2), (3) as noted, may be permitted to become more negative than Com (5). No pin may be permitted to become more positive than V_S (13).

PIN CONFIGURATION (N, R, Q PACKAGE)

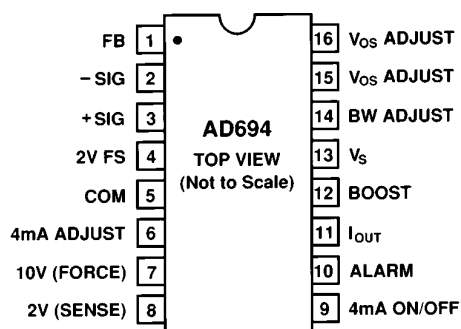

ORDERING GUIDE

Model	Temperature Range	Package Option*
AD694JN	0°C to +70°C	N-16
AD694AQ	-40°C to +85°C	Q-16
AD694AR	-40°C to +85°C	R-16
AD694BQ	-40°C to +85°C	Q-16
AD694BR	-40°C to +85°C	R-16

*N = Plastic DIP; Q = Cerdip, R = SOIC.

AD694

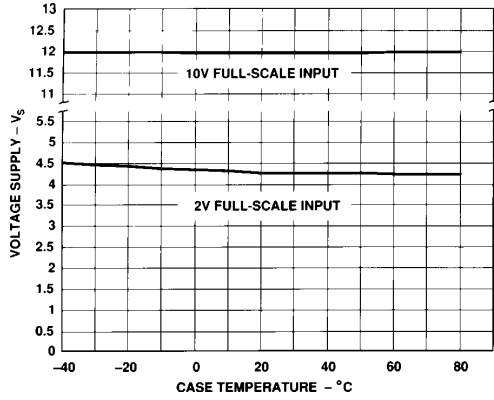

Typical Minimum Supply Voltage vs. Temperature for 2 V & 10 V Full Scale

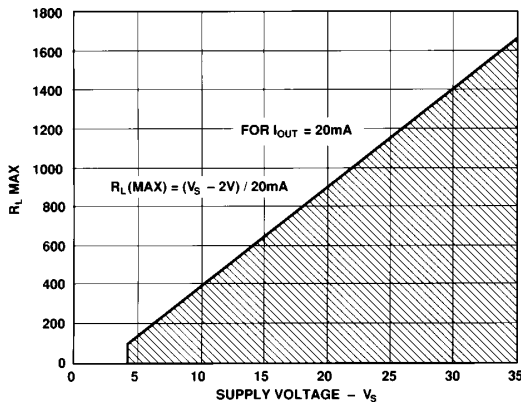

Maximum R_L vs. Supply Voltage

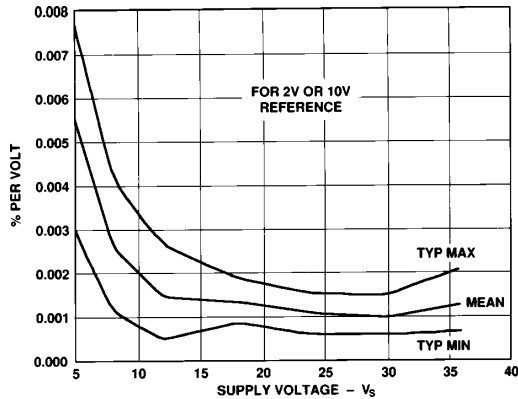

Voltage Reference Power Supply Rejection

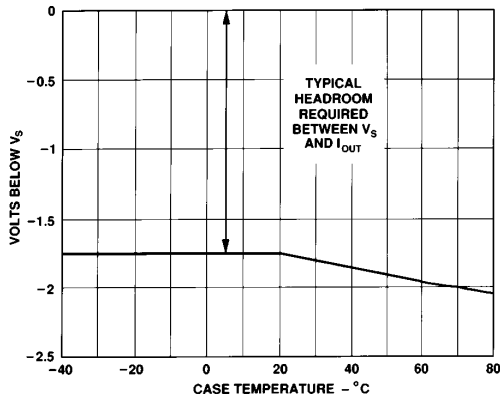

I_{OUT} : Voltage Compliance vs. Temperature

FUNCTIONAL DESCRIPTION

The operation of the AD694 can best be understood by dividing the circuit into three functional parts (see Figure 1). First, a single supply input amplifier buffers the high level, single-ended input signal. The buffer amplifier drives the second section, a voltage to current (V/I) converter, that makes a 0 to 16 mA signal dependent current.

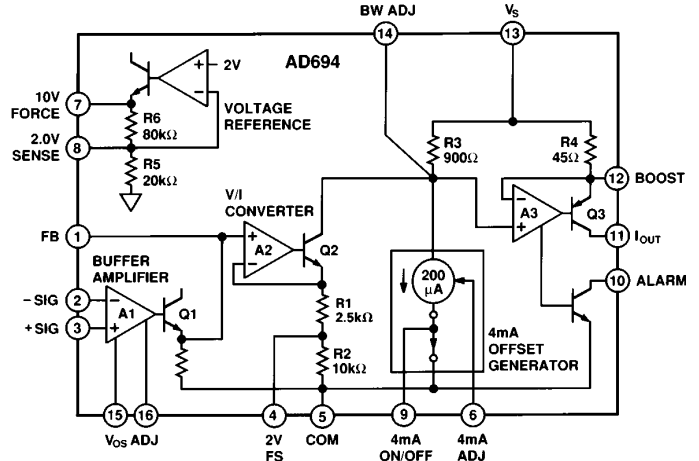

Figure 1. Functional Block Diagram

The third section, a voltage reference and offset generator, is responsible for providing the 4 mA offset current signal.

BUFFER AMPLIFIER

The buffer amplifier is a single supply amplifier that may be used as a unity gain buffer, an output amplifier for a current output D/A converter, or as a gain block to amplify low level signals. The amplifier's PNP input stage has a common-mode range that extends from a few hundred mV below ground to within 2.5 V of V_S . The Class A output of the amplifier appears at Pin 1 (FB). The output range extends from about 1 mV above common to within 2.5 V of V_S when the amplifier is operated as a follower. The amplifier can source a maximum load of 5 k Ω , but can sink only as much as its internal 10 k Ω pulldown resistor allows.

V/I CONVERTER

The ground referenced, input signal from the buffer amplifier is converted to a 0 to 0.8 mA current by A2 and level shifted to the positive supply. A current mirror then multiplies this signal by a factor of 20 to make the signal current of 0 to 16 mA. This technique allows the output stage to drive a load to within 2 V of the positive supply (V_S). Amplifier A2 forces the voltage at Pin 1 across resistors R1 and R2 by driving the Darlington transistor, Q2. The high gain Darlington transmits the resistor current to its collector and to R3 (900 Ω). A3 forces the level shifted signal across the 45 Ω resistor to get a current gain of 20. The transfer function of the V/I stage is therefore:

$$I_{OUT} = \left(20 \times V_{(PIN1)} \right) / (R1 + R2)$$

resulting in a 0-16 mA output swing for a 0-10 V input. Tying Pin 4 (2 V FS) to ground shorts out R2 and results in a 2 V full-scale input for a 16 mA output span.

The output stage of the V/I converter is of a unique design that allows the I_{OUT} pin to drive a load below the common (substrate) potential of the device. The output transistor can always

drive a load to a point 36 V below the positive supply (V_S). An optional NPN pass transistor can be added to transfer most of the power dissipation off-chip, to extend the temperature range of operation.

The output stage is current-limited at approximately 38 mA to protect the output from an overdrive at its inputs. The V/I will allow linear operation to approximately 24 mA. The V/I converter also has an open collector alarm (Pin 10) which warns of open-circuit condition at the I_{OUT} pin or of attempts to drive the output to a voltage greater than $V_S - 2$ V.

4 mA OFFSET GENERATOR

This circuit converts a constant voltage from the voltage reference to a constant current of approximately 200 μ A. This current is summed with the signal current at Pin 14 (BW Adjust), to result in a constant 4 mA offset current at I_{OUT} . The 4 mA Adj (Pin 6) allows the offset current to be adjusted to any current in the range of 2 mA to 4.8 mA. Pin 9 (4 mA On/Off) can shut off the offset current completely if it is lifted to 3.0 V or more, allowing 0 to 20 mA operation of the AD694. In normal 4-20 mA operation, Pin 9 is connected to ground.

VOLTAGE REFERENCE

A 2 V or 10 V voltage reference is available for user applications, selectable by pin-strapping. The 10 V option is available for supply voltages greater than 12.5 V, the 2 V output is available over the whole 4.5 V – 36 V power supply range. The reference can source up to 5 mA for user applications. A boost transistor can be added to increase the current drive capability of the 2 V mode.

APPLYING THE AD694

The AD694 can easily be connected for either dual or single supply operation, to operate from supplies as low as 4.5 V and as high as 36 V. The following sections describe the different connection configurations, as well as adjustment methods. Table I shows possible connection options.

Table I. Precalibrated Ranges for the AD694

Input Range	Output Range	Voltage Reference	Min V_S	Pin 9	Pin 4	Pin 8
0–2 V	4–20 mA	2 V	4.5 V	Pin 5	Pin 5	Pin 7
0–10 V	4–20 mA	2 V	12.5 V	Pin 5	Open	Pin 7
0–2.5 V	0–20 mA	2 V	5.0 V	≥ 3 V	Pin 5	Pin 7
0–12.5 V	0–20 mA	2 V	15.0 V	≥ 3 V	Open	Pin 7
0–2 V	4–20 mA	10 V	12.5 V	Pin 5	Pin 5	Open
0–10 V	4–20 mA	10 V	12.5 V	Pin 5	Open	Open
0–2.5 V	0–20 mA	10 V	12.5 V	≥ 3 V	Pin 5	Open
0–12.5 V	0–20 mA	10 V	15.0 V	≥ 3 V	Open	Open

BASIC CONNECTIONS: 12.5 V SINGLE SUPPLY OPERATION WITH 10 V FS

Figure 2 shows the minimal connections required for basic operation with a +12.5 V power supply, 10 V input span, 4–20 mA output span, and a 10 V voltage reference. The buffer amplifier is connected as a voltage follower to drive the V/I converter by connecting FB (Pin 1) to –Sig (Pin 2). 4 mA On/Off (Pin 9) is tied to ground (Pin 5) to enable the 4 mA offset current. The AD694 can drive a maximum load $R_L = [V_S - 2 \text{ V}] / 20 \text{ mA}$, thus the maximum load with a 12.5 V supply is 525 Ω .

SELECTING A 2 V FULL-SCALE INPUT

The 2 V full-scale option is selected by shorting Pin 4 (2 V FS) to Pin 5 (Common). The connection should be as short as possible; any parasitic resistance will affect the precalibrated span accuracy.

SELECTING THE 2 V VOLTAGE REFERENCE

The voltage reference is set to a 2 V output by shorting Pin 7 to Pin 8 (10 V Force to 2 V Sense). If desired, the 2 V reference can be set up for remote force and sense connection. Keep in mind that the 2 V Sense line carries a constant current of 100 μ A that could cause an offset error over long wire runs. The 2 V reference option can be used with all supply voltages greater than 4.5 V.

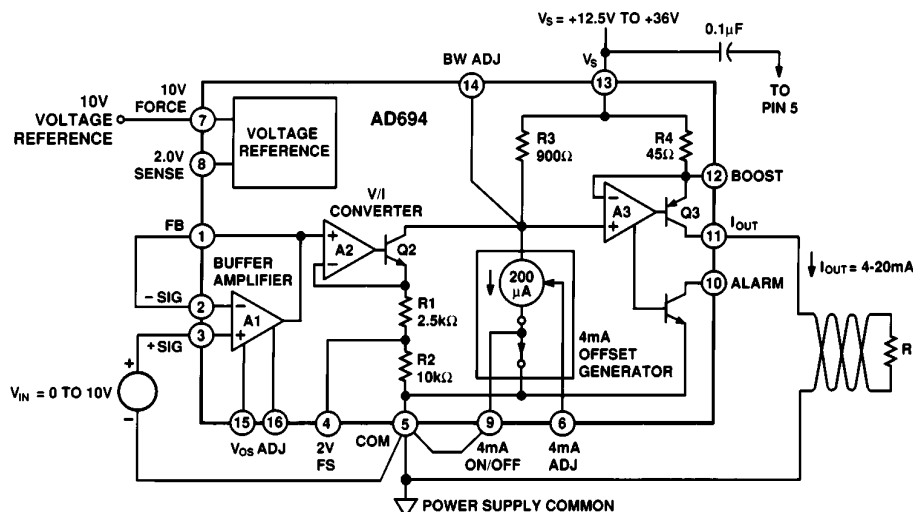

Figure 2. Minimal Connections for 0-10 V Single-Ended Input, 4-20 mA Output, 10 V Reference Output

AD694

An NPN boost transistor can be added in the 2 V mode to increase the current drive capability of the 2 V reference. The 10 V force pin is connected to the base of the NPN, and the NPN emitter is connected to the 2 V sense pin. The minimum V_S of the part increases by approximately 0.7 V.

4.5 V SINGLE SUPPLY OPERATION

For operation with a +4.5 V power supply, the input span and the voltage reference output must be reduced to give the amplifiers their required 2.5 V of head room for operation. This is done by adjusting the AD694 for 2 V full-scale input, and a voltage reference output of 2 V as described above.

GENERAL DESIGN GUIDELINES

A 0.1 μF decoupling capacitor is recommended in all applications from V_S (Pin 13) to Com (Pin 5). Additional components may be required if the output load is nonresistive, see section on driving nonresistive loads. The buffer amplifier PNP inputs should not be brought more than -0.3 V of common, or they will begin to source large amounts of current. Input protection resistors must be added to the inputs if there is a danger of this occurring. The output of the buffer amplifier, Pin 1 (FB), is not short circuit protected. Shorting this pin to ground or V_S with a signal present on the amplifier may damage it. Input signals should not drive Pin 1 (FB) directly; always use the buffer amplifier to buffer input signals.

DRIVING NONRESISTIVE LOADS

The AD694 is designed to be stable when driving resistive loads. Adding a 0.01 μF capacitor from I_{OUT} (Pin 11) to Com (Pin 5), as shown in Figure 3, insures the stability of the AD694 when driving inductive or poorly defined loads. This capacitor is recommended when there is any uncertainty as to the characteristics of the load.

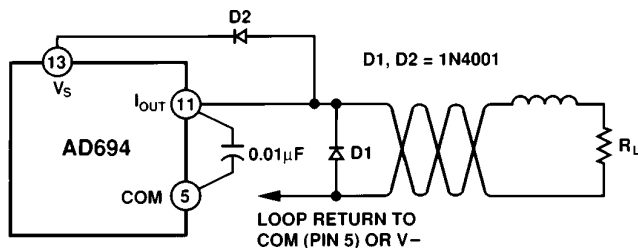

Figure 3. Capacitor Utilized When Driving Nonresistive Loads; Protection Diodes Used When Driving Inductive Loads

Additional protection is recommended when driving inductive loads. Figure 3 shows two protective diodes, D1 and D2, added to protect against voltage spikes that may extend above V_S or below common that could damage the AD694. These diodes should be used in addition to the 0.01 μF capacitor. When the optional NPN transistor is used, the capacitor and diodes should connect to the NPN emitter instead of Pin 11.

0-20 mA OPERATION

A 0-20 mA output range is available with the AD694 by removing the 4 mA offset current with the 4 mA On/Off pin. In normal 4-20 mA operation 4 mA On/Off (Pin 9) is tied to ground, enabling the 4 mA offset current. Tying Pin 9 to a potential of 3 V or greater turns off the 4 mA offset current; connecting Pin 9 to the 10 V reference, the positive supply, or a TTL control pin, is a convenient way to do this. In 0-20 mA mode the input span is increased by 20%, thus the precalibrated input spans of 2 V and 10 V become 2.5 V and 12.5 V. Minimum supply voltages for the two spans increase to 5 V and 15 V.

The 4 mA On/Off pin may also be used as a “jiggle pin” to unstick valves or actuators, or as a way to shut off a 4-20 mA loop entirely. Note that the pin only removes the 4 mA offset and not the signal current.

DUAL SUPPLY OPERATION

Figure 4 shows the AD694 operated in dual supply mode. (Note that the pass transistor is shown for illustration and is not required for dual supply operation.) The device is powered completely by the positive supply which may be as low as 4.5 V. The unique design of the output stage allows the I_{OUT} pin to extend below common to a negative supply. The output stage can source a current to a point 36 V below the positive supply. For example, when operated with a +12.5 V supply, the AD694 can source a current to a point as low as 23.5 V below common. This feature can simplify the interface to dual supply D/A converters by eliminating grounding and level-shifting problems while increasing the load that the transmitter is able to drive. Note that the I_{OUT} pin is the only pin that should be allowed to extend lower than -0.3 V of common.

OPERATION WITH A PASS TRANSISTOR

The AD694 can operate as a stand-alone 4-20 mA converter with no additional active components. However, provisions have been made to connect I_{OUT} to the base of an external NPN pass transistor as shown in Figure 4. This permits a majority of the power dissipation to be moved off-chip to enhance performance and extend the temperature range of operation. Note that the positive output voltage compliance is reduced by approximately 0.7 V, the V_{BE} of the pass device. A 50 Ω resistor should be added in series with the pass transistor collector, when the AD694 is operated with dual supplies, as shown in Figure 4. This will not reduce the voltage compliance of the output stage.

The external pass transistor selected should have a BV_{CEO} greater than the intended supply voltage with a sufficient power rating for continuous operation with 25 mA current at the supply voltage. f_t should be in the 10 MHz to 100 MHz range and β should be greater than 10 at a 20 mA emitter current. Heat sinking the external pass transistor is suggested.

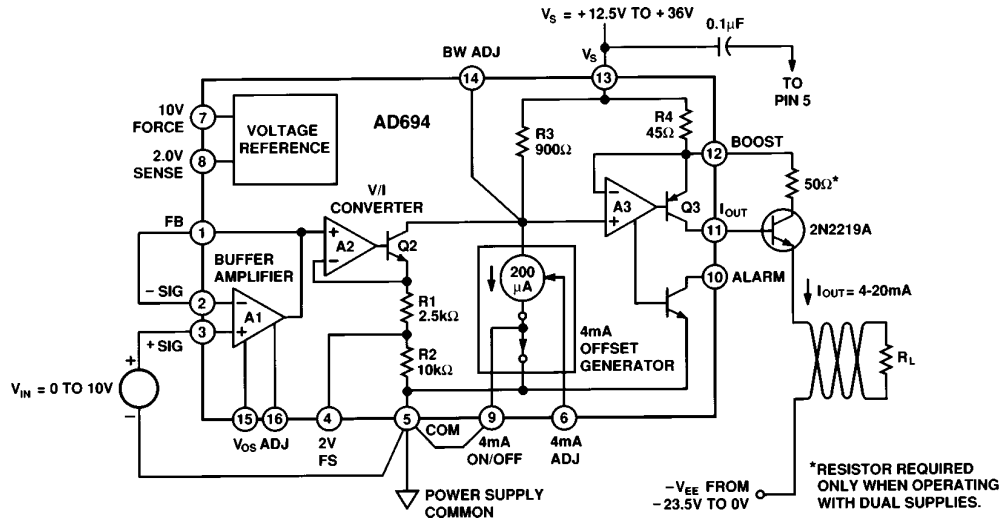

Figure 4. Using Optional Pass Transistor to Minimize Self-Heating Errors; Dual Supply Operation Shown

POWER DISSIPATION CONSIDERATIONS

The AD694 is rated for operation over its specified temperature without the use of an external pass transistor. However, it is possible to exceed the absolute maximum power dissipation, with some combinations of power supply voltage and voltage reference load. The internal dissipation of the part can be calculated to determine if there is a chance that the absolute maximum dissipation may be exceeded. The die temperature must never exceed 150°C.

Total power dissipation (P_{TOT}), is the sum of power dissipated by the internal amplifiers, P (Standing), the voltage reference, $P(V_{REF})$ and the current output stage, $P(I_{OUT})$ as follows:

$$P_{TOT} = P(Standing) + P(V_{REF}) + P(I_{OUT})$$

where:

$$P(Standing) = 2\text{ mA (max)} \times V_S$$

$$P(V_{REF}) = (V_S - V_{REF}) \times I_{VREF}$$

$$P(I_{OUT}) = (V_S - V_{OUT}) \times I_{OUT} \text{ (max)}$$

$I_{OUT} \text{ (max)}$ may be the max expected operating current, or the overdriven current of the device.

$P(I_{OUT})$ drops to (2 Volts \times I_{OUT}) if a pass transistor is used.

Definitions:

V_{REF} = output voltage of reference

I_{VREF} = output current of reference

V_S = supply voltage

V_{OUT} = voltage at I_{OUT} pin.

An appropriate safety factor should be added to P_{TOT} .

The junction temperature may be calculated with the following formula:

$$T_j = P_{TOT} (\theta_{jC} + \theta_{CA}) + T_{AMBIENT}$$

θ_{jC} is the thermal resistance between the chip and the package (case), θ_{CA} is the thermal resistance between the case and its surroundings and is determined by the characteristics of the thermal connection of the case to ambient.

For example, assume that the part is operating with a V_S of 24 V in the cerdip package at 50°C, with a 1 mA load on the 10 V reference. Assume that I_{OUT} is grounded and that the max I_{OUT} would be 20 mA. The internal dissipation would be:

$$P_{TOT} = 2\text{ mA} \times 24\text{ V} + (24\text{ V} - 10\text{ V}) \times 1\text{ mA} + (24\text{ V} - 0\text{ V}) \times 20\text{ mA}$$

$$= 48\text{ mW} + 14\text{ mW} + 480\text{ mW} = 542\text{ mW}$$

Using θ_{jC} of 30°C/Watt and θ_{CA} of 70°C/Watt, (from spec page) the junction temperature is:

$$T_j = 542\text{ mW} (30^\circ\text{C/W} + 70^\circ\text{C/W}) + 50^\circ\text{C} = 104.2^\circ\text{C}$$

The junction temperature is in the safe region.

Internal power dissipation can be reduced either by reducing the value of θ_{CA} through the use of air flow or heat sinks, or by reducing P_{TOT} of the AD694 through the use of an external pass transistor. Figure 5 shows the maximum case and still air temperatures for a given level of power dissipation.

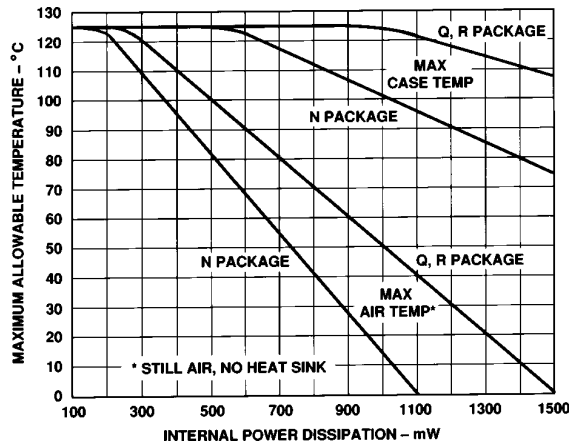

Figure 5. Internal Power Dissipation in mW

ADJUSTMENT PROCEDURES

The following sections describe methods for trimming the output current offset, the span and the voltage reference.

ADJUSTING 4 mA ZERO

The 4 mA zero current may be adjusted over the range of 2 mA to 4.8 mA to accommodate large input signal offsets, or to allow small adjustment in the zero current. The zero may be adjusted by pulling up or down on Pin 6 (4 mA Adj) to increase or decrease the nominal offset current. The 4 mA Adj. (Pin 6) should not be driven to a voltage greater than 1 V. The arrangement of

AD694

Figure 6 will give an approximately linear adjustment of the 4 mA offset within fixed limits. To find the proper resistor values, first select X, the desired range of adjustment as a fraction of 4 mA. Substitute this value in the appropriate formula below along with the chosen reference output voltage ($V_{REF} = 2\text{ V}$ or 10 V usually), to determine the resistor values required.

$$R_P = 180\ \Omega (1/X - 4.5)$$

$$R_F = 500\ \Omega [(V_{REF} / 1.22\text{ V}) - 0.18 - 0.82X] / [1/X - 4.5]$$

These formulae take into account the $\pm 10\%$ internal resistor tolerance and ensure a minimum adjustment range for the 4 mA offset. For example, assume the 2 V reference option has been selected. Choosing $X = 0.05$; gives an adjustment range of $\pm 5\%$ of the 4 mA offset.

$$R_P = 180\ \Omega (1/0.05 - 4.5) = 2.79\text{ k}\Omega$$

$$R_F = 500\ \Omega [(2\text{ V} / 1.22) - 0.18 - 0.82 \times 0.05] / [1/0.05 - 4.5] = 10.99\text{ k}\Omega$$

These can be rounded down to more convenient values of 2.5 k Ω and 9.76 k Ω . In general, if the value of R_P is rounded down slightly, the value of R_F should be rounded down proportionately and vice versa. This helps to keep the adjustment range symmetrical.

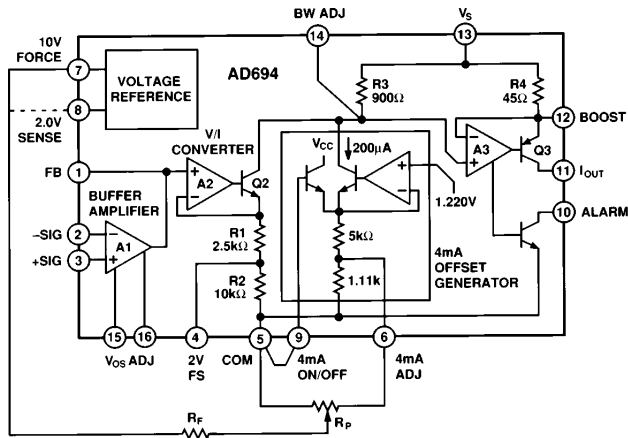

Figure 6. Optional 4 mA Zero Adjustment

ADJUSTING SPAN FOR 10 V FS

When the AD694 is configured with a 10 V input full-scale the span may be adjusted using the network shown in Figure 7. This scheme allows an approximately linear adjustment of the span above or below the nominal value. The span adjustment does not interact with the 4 mA offset. To select R_S and R_T , choose

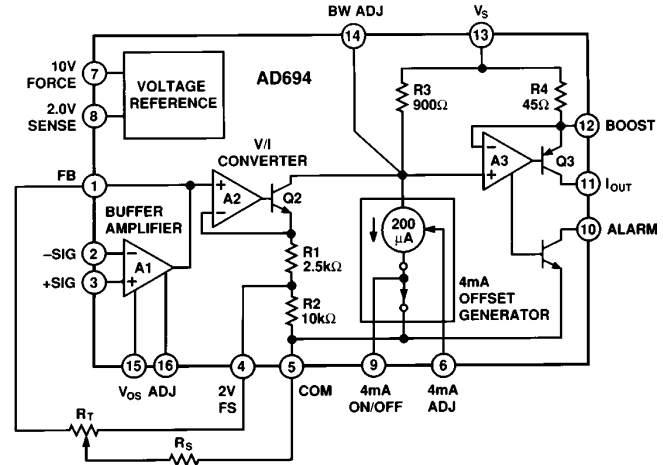

Figure 7. Span Adjustment, 10 V Full Scale

X, the desired adjustment range as a fraction of the span. Substitute this value in the appropriate formula below.

$$R_T = 1.8\text{ k}\Omega ((1 - X)/X)$$

$$R_S = 9\text{ k}\Omega [1 - 0.2(1 + X)(1 - X)] / 2X$$

These formulae take into account the $\pm 10\%$ absolute resistor tolerance of the internal span resistors and ensures a minimum adjustment range of the span. For example, choosing the adjustment range to be $\pm 2\%$, or 0.02 gives:

$$R_T = 1.8\text{ k}\Omega ((1 - 0.02) / 0.02) = 88.2\text{ k}\Omega$$

$$R_S = 9\text{ k}\Omega [1 - 0.2(1 + 0.02)(1 - 0.02)] / (2 \times 0.02) = 175.5\text{ k}\Omega$$

These values can be rounded up to the more convenient values of 100 k Ω and 198 k Ω . In general, if R_T is rounded up, then the value of R_S should be rounded up proportionally and vice versa.

ADJUSTING SPAN FOR 2 V FS

The precalibrated 2 V full-scale range requires a different adjustment scheme due to the single supply nature of the AD694. Figure 8 shows an adjustment scheme that allows an approximately linear adjustment of the 2 V span plus or minus the nominal value. The span adjustment does not affect the value of the 4 mA offset current.

To find the proper resistor values first select X, the desired range of adjustment as a fraction of the output span. Substitute this value into the following formulae:

$$R_A = 2 \times X \times R_B \text{ where } R_B \text{ is greater than } 5\text{ K}$$

$$R_C = (2.75\text{ k}\Omega \times X) / (1 - 0.275X)$$

These formulae take into account the $\pm 10\%$ absolute tolerance of the internal span resistors and ensure a minimum adjustment range.

For example, choosing the adjustment range to be $\pm 320\ \mu\text{A}$ of FS or, $\pm 2\%$, let $X = 0.02$. Thus:

$$\text{Setting } R_B = 10\text{ K, then } R_A = 2(.02) \times 10\text{ k}\Omega = 400\ \Omega$$

$$R_C = (2.75\text{ k}\Omega \times 0.02) / (1 - 0.275 \times (0.02)) = 55.3\ \Omega$$

The value of R_C can be rounded to the more convenient values of 49.9 Ω . In general, if R_A is rounded up, then R_C should be rounded up proportionally and vice versa; rounding up will increase the range of adjustment.

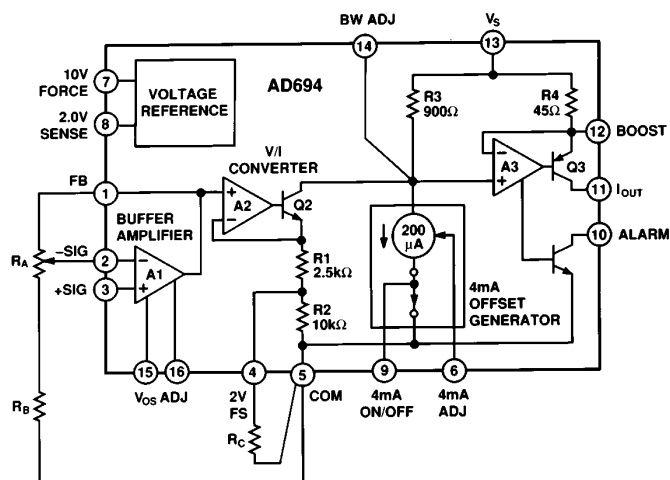

Figure 8. Span Adjustment, 2 V Full Scale

PROGRAMMING OTHER SPANS

There are two methods for programming input spans less than 10 V. The first decreases the input span by programming a non-inverting gain into the buffer amplifier. For example, to achieve an input span of 0–5 V, the AD694 is set in its 10 V full-scale mode and the buffer amplifier is configured with a noninverting gain of 2 by adding 2 resistors. Now a 5 V signal at +Sig results in a 10 V full-scale signal at FB (Pin 1), the input to the V/I. This method requires that the V/I be programmed to a 10 V full scale for input spans between 2 V to 10 V. It should be programmed to a 2 V full scale if input spans of less than 2 V are required. This adjustment scheme makes the accuracy of the span adjustment dependent upon the ratio accuracy of the required gain resistors. Thus, it is possible to accurately configure spans other than 2 V or 10 V without using trimming potentiometers, given that the resistor ratios are sufficiently accurate. A supply voltage of 12.5 V is required for spans between 2 V and 10 V. Spans below 2 V require a V_S of 4.5 V or greater.

A second method, allows other spans of less than 10 V to be programmed when supply voltage is less than 12.5 V. Since the AD694 amplifiers require 2.5 V of headroom for operation, a 5 V full-scale input is possible with a 7.5 V supply. This is achieved by placing a resistor, in parallel with R2, (2 V FS (Pin 4) to Com (Pin 5)), to adjust the transconductance of the V/I converter without a headroom penalty. A disadvantage of this method is that the external resistor must match the internal resistor in a precise manner, thus a span trim will be required. The value should be chosen to allow for the $\pm 10\%$ uncertainty in the absolute value of the internal resistor R2.

ADJUSTING REFERENCE OUTPUT

Figure 9 shows one method of making small adjustments to the 10 V reference output. This circuit allows a linear adjustment range of ± 200 mV. The 2 V reference may also be adjusted but only in the positive direction.

Other reference voltages can be programmed by adding external resistors. For example, a resistor placed in parallel with R5 can be added to boost the reference output as high as 20 V. Conversely, a resistor in parallel with R6 can be used to set the reference voltage to a value between 2 V and 10 V. The output voltage $V_{REF} = 2 \text{ V} (R_6 + R_5) / R_5$. In choosing external

adjustment resistors remember that the internal resistors, while ratio matched to a high degree of accuracy, have an absolute resistor tolerance of only $\pm 10\%$. Be prepared to compensate for this if a precise voltage other than the precalibrated values of 2 V or 10 V is required.

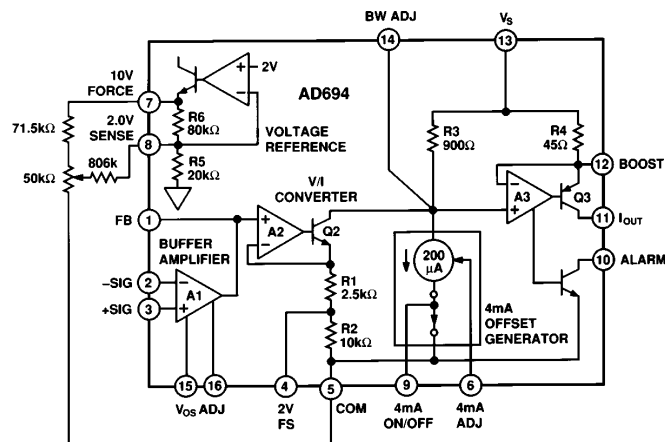

Figure 9. 10 V Reference Output Adjustment

BANDWIDTH CONTROL

The bandwidth of the AD694 can be limited to provide noise filtering. This is achieved by connecting an external capacitor from BW ADJ (Pin 14) to V_S (Pin 13) as shown in Figure 10. To program the bandwidth, substitute the desired bandwidth in Hz, into the formula below to determine the required capacitor.

$$C = 1 \text{ farad Hz } \Omega / (2 \pi 900 \Omega \text{ BW})$$

The bandwidth chosen will vary $\pm 10\%$ due to internal resistor tolerance, plus an additional amount due to capacitor tolerance.

This method of bandwidth control is not recommended as a way to filter large high frequency transients in the input signal. It is recommended that frequencies greater than the BW of the buffer amplifier be eliminated with an input filter to avoid rectification of noise by the input amplifiers.

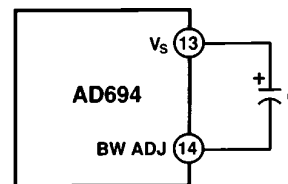

Figure 10. Noise Filtering with an External Capacitor

BUFFER AMPLIFIER OFFSET ADJUST

The buffer amplifier input voltage offset has been laser trimmed to a high degree of accuracy; however, there may be occasions when an offset trim is desired. Figure 11 shows the adjustment method; a trim range of greater than ± 2.5 mV is available with this scheme. It is not recommended that this adjustment method be used to affect the 4 mA offset current as the trim will induce offset drift into the buffer amplifier. The buffer amplifier will drift approximately $1 \mu\text{V}/^\circ\text{C}$ for each $300 \mu\text{V}$ of induced offset. To adjust the 4 mA offset current refer to the section "ADJUSTING ZERO."

AD694

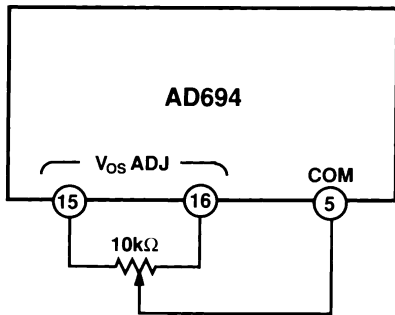

Figure 11. Buffer Amplifier V_{OS} Adjustment

ALARM CIRCUIT

The AD694 has an alarm circuit which warns of open circuit conditions at I_{OUT} (Pin 11), or of attempts to drive the voltage at I_{OUT} higher than $V_S - 2$ V. The alarm transistor will pull down if an out of control condition is sensed. The alarm current is limited to about 20 mA.

Figure 12 shows a typical application. In a digital/analog system the alarm can provide a TTL signal to a controller. The collector of the alarm transistor is tied to the system logic supply through a 20 k Ω pull-up resistor. The alarm is off in normal operation and the voltage at the alarm pin is high. In the event that the wire from I_{OUT} (Pin 11) is opened, or if a large input overdrive forces I_{OUT} too close to V_S , then the alarm pin is driven low. This configuration is compatible with CMOS or TTL logic levels. The alarm transistor can also be used to directly drive an LED or other indicators.

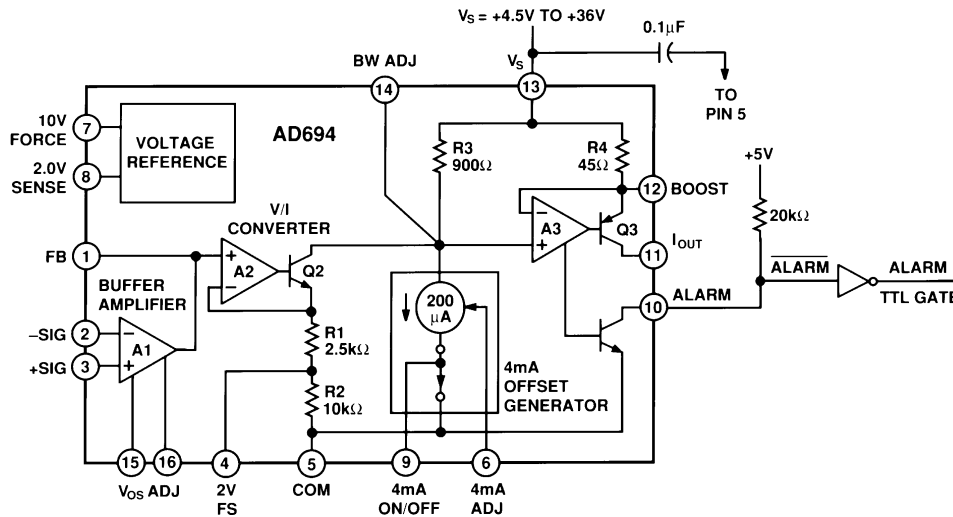

Figure 12. Using the Alarm to Drive a TTL Gate

APPLICATIONS

CURRENT OUTPUT DAC INTERFACE

The AD694 can be easily interfaced to current output DACs such as the AD566A to construct a digital to 4–20 mA interface as shown in Figure 13. The AD694 provides the voltage reference and the buffer amplifier necessary to operate the DAC. Only simple connections are necessary to construct the circuit. The 10 V reference of the AD694 supplies reference input of the AD566. The buffer amplifier converts the full-scale current to +10 V utilizing the internal resistors in the DAC; therefore the AD694 is configured for a 10 V full-scale input. A 10 pF capacitor compensates for the 25 pF output capacitance of the DAC. An optional 100 Ω trim resistor, (R_T), allows the full-scale to be trimmed, a 50 Ω resistor may be substituted if a trim is not required; accuracy will be typically ± 1 LSB and the trim does not affect the 4 mA offset. Care should be taken in managing the circuit grounds. Connections from AD694 Pins 9, 3 and AD566 Pins 3 and 7 should be as short as possible and to a single point close to Pin 5 of the AD694. Best practice would have separate connections to the star ground from each pin; this is essential

for the AD566 power ground from Pin 12. The 4–20 mA output (Pin 11) must have a return path to the power ground. The return line from the load may be connected to the power ground, or to the -15 V supply based upon the size of the load to be driven, and on power dissipation considerations.

SINGLE SUPPLY DIGITAL TO 4–20 mA INTERFACE

A 12 bit input to 4–20 mA output interface can be constructed that operates on a single 15 V supply. The DAC is operated in its voltage switching mode; this allows the DAC, when supplied with a voltage reference of less than 2.5 V, to provide an output voltage that is proportional to the digital input code and ranges from 0 V to V_{REF} . The AD694 voltage reference is connected to supply 2 V and the input stage is set to a 2 V full scale; the input buffer amplifier serves to buffer the voltage output from the DAC. Connected in this manner a full-scale DAC input code will result in a 20 mA output and an all 0 code will result in a 4 mA output. The loading on the AD694 voltage reference is

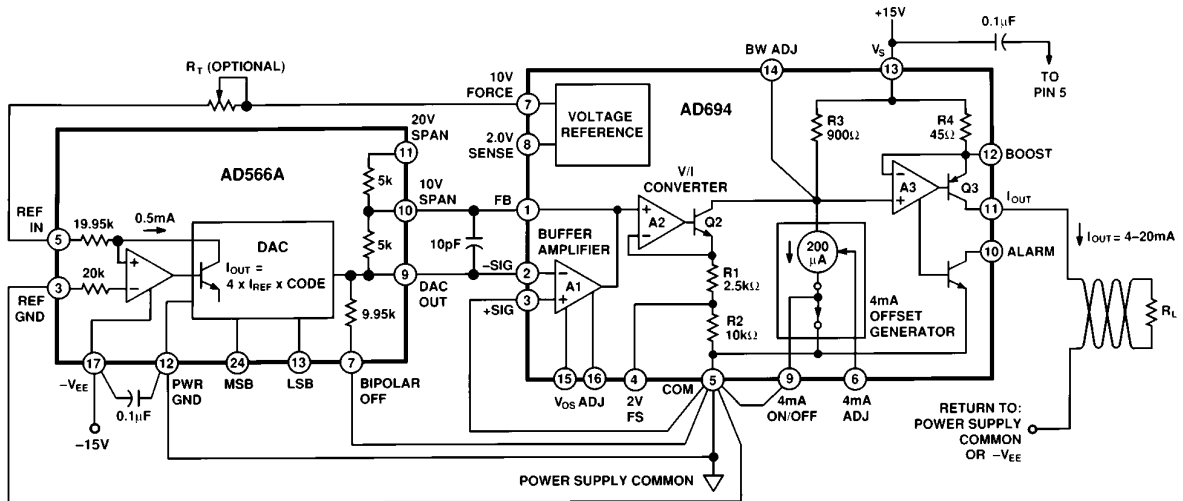

Figure 13. Digital to 4–20 mA Interface Using a Current Steering DAC

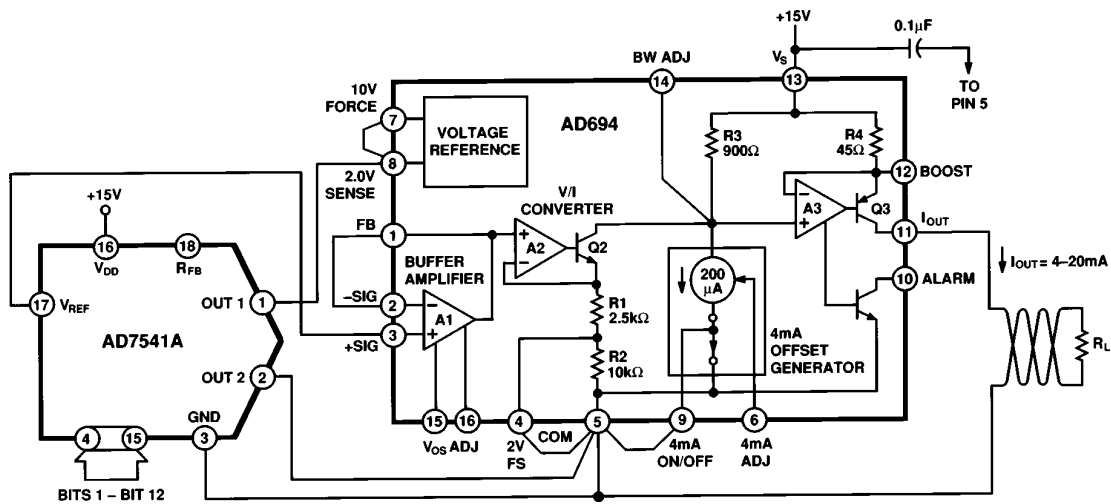

Figure 14. Single Supply Digital Input to 4–20 mA Output

code dependent, and the response time of the circuit will be determined by the reaction of the voltage reference. The supply voltage to the AD7541A should be kept close to 15 V. If V_S is reduced significantly from 15 V the differential nonlinearity of the DAC will increase and the linearity will be degraded.

In some applications it is desirable to have some under-range and overrange in the 4–20 mA output. For example, assume an over and under range capability of $\pm 5\%$ of span is needed, then the output current range corresponding to the full scale of the DAC is 3.2 mA to 20.8 mA. To accomplish this, the span of the AD694 would be increased 10% to 17.6 mA by adding a non-inverting gain of 1.1 to the buffer amplifier. The 4 mA offset would then be reduced by 0.8 mA, by utilizing the adjustment scheme explained in “Adjusting 4 mA Zero.” Then a digital input from all zero code to full scale would result in an output current of 3.2 mA to 20.8 mA.

LOW COST SENSOR TRANSMITTER

Sensor bridges typically output differential signals in the 10 mV to 100 mV full-scale range. With an AD694, a dual op amp, and some resistors, an instrumentation amplifier front end can be added which easily handles these types of low level signals.

The traditional 3 op amp instrumentation amplifier is built using an AD708, dual op amp for the front end, and the AD694’s buffer amplifier is used for the subtractor circuit, as shown in Figure 15. The AD694’s 2 V reference is used to provide a “ground” of 2 V that insures proper operation of the in amp over a wide common mode range. The reference pin of the subtractor circuit is tied to the 2 V reference (point C). A 2 kΩ pull-down resistor insures that the voltage reference will be able to sink any subtractor current. The 2 V FS (Pin 4) is attached to the 2 V reference; this offsets the input range of the V/I converter 2 volts positive, to match the “ground” of the in amp.

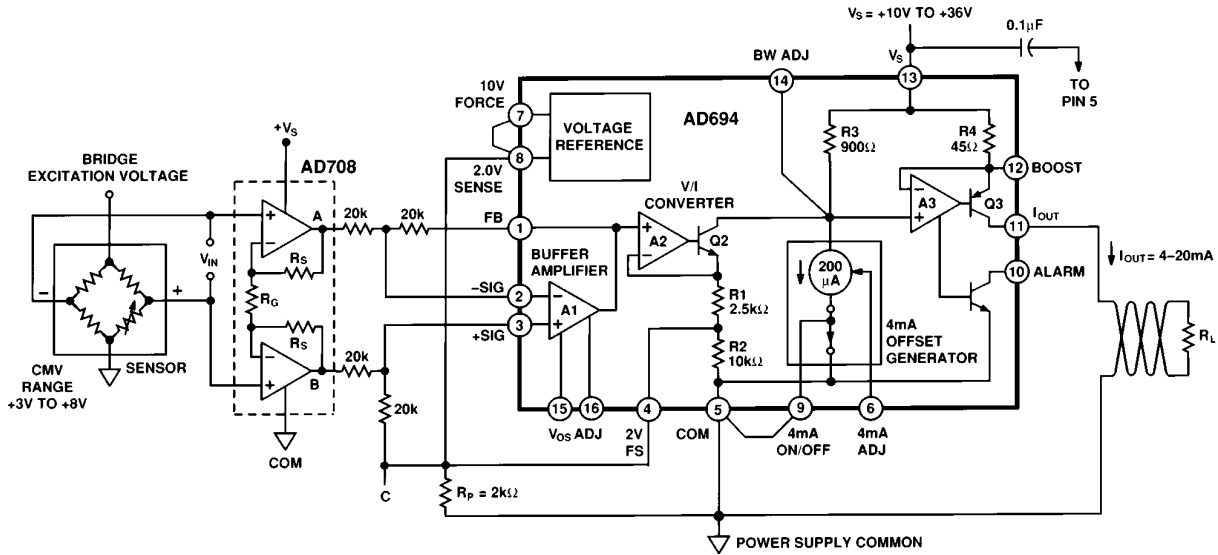

Figure 15. Low Cost Sensor Transmitter

The AD694 will now output a 4-20 mA output current for a 0 to 2 V differential swing across V_A . The gain of the in amp front end is adjusted so that the desired full-scale input signal at V_{IN} results in a V_A of 2 V. For example a sensor that has a 100 mV full scale will require a gain of 20 in the front end. The gain is determined according to the equation:

$$G = [2R_s/R_g] + 1$$

The circuit shown, will convert a positive differential signal at V_{IN} to a 4-20 mA current. The circuit has common-mode range of 3 V to 8 V. The low end of the common-mode range is limited

by the AD708's ability to pull down on R_s . A single supply amplifier could be used instead to extend the common-mode range down to about 1.5 V.

As shown, the circuit handles positive differential signals, (V_{IN} positive). To handle bipolar differential signals (V_{IN} is positive or negative), the reference pin of the in amp (point C) must be offset positively from the 2 V reference. For example, disconnected point C from the 2 V reference and connecting it to a 3 V source would result in a V_A of 1 V, (or half scale) for a zero volt differential input from the sensor.

OUTLINE DIMENSIONS

Dimensions shown in inches and (mm).

16-Lead Cerdip (Q) Package

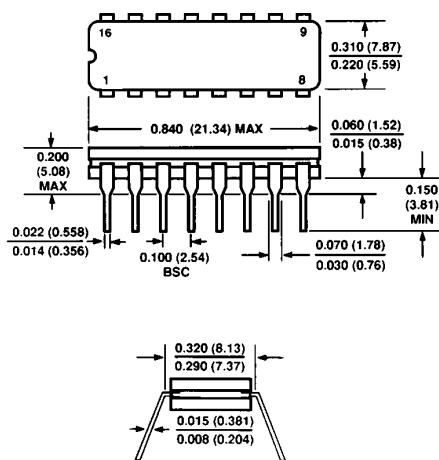

16-Lead Plastic DIP (N) Package

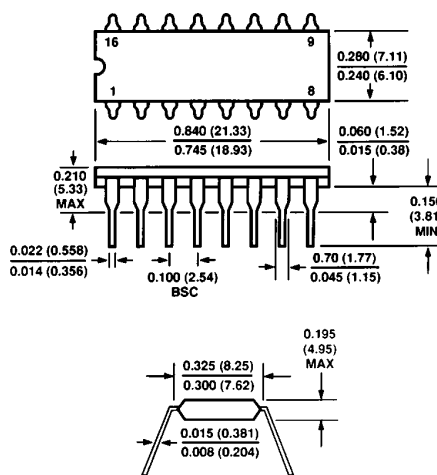

16-Pin SOIC (R) Package

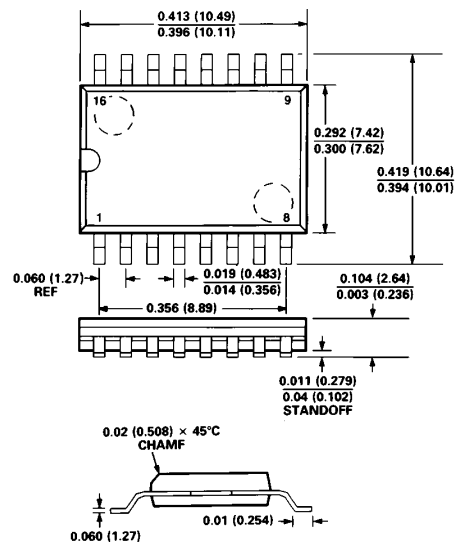

C1403a-10-8/91

PRINTED IN U.S.A.