

ADG406/ADG407/ADG426

FEATURES

44 V Supply Maximum Ratings

V_{SS} to V_{DD} Analog Signal Range

Low On Resistance (80 Ω max)

Low Power

Fast Switching

t_{ON} < 160 ns

t_{OFF} < 150 ns

Break Before Make Switching Action

Plug-In Upgrade for

DG506A/ADG506A, DG507A/ADG507A,

DG526/ADG526A

ADG406/ADG407 are Plug-In Replacements for
DG406/DG407

APPLICATIONS

Audio and Video Routing

Automatic Test Equipment

Data Acquisition Systems

Battery Powered Systems

Sample Hold Systems

Communication Systems

Avionics

GENERAL DESCRIPTION

The ADG406, ADG407 and ADG426 are monolithic CMOS analog multiplexers. The ADG406 and ADG426 switch one of sixteen inputs to a common output as determined by the 4-bit binary address lines A0, A1, A2 and A3. The ADG426 has on-chip address and control latches that facilitate microprocessor interfacing. The ADG407 switches one of eight differential inputs to a common differential output as determined by the 3-bit binary address lines A0, A1 and A2. An EN input on all devices is used to enable or disable the device. When disabled, all channels are switched OFF.

The ADG406/ADG407/ADG426 are designed on an enhanced LC²MOS process that provides low power dissipation yet gives high switching speed and low on resistance. These features make the parts suitable for high speed data acquisition systems and audio signal switching. Low power dissipation makes the parts suitable for battery powered systems. Each channel conducts equally well in both directions when ON and has an input signal range which extends to the supplies. In the OFF condition, signal levels up to the supplies are blocked. All channels exhibit break before make switching action preventing momentary shorting when switching channels. Inherent in the design is low charge injection for minimum transients when switching the digital inputs.

REV. 0

Information furnished by Analog Devices is believed to be accurate and reliable. However, no responsibility is assumed by Analog Devices for its use, nor for any infringements of patents or other rights of third parties which may result from its use. No license is granted by implication or otherwise under any patent or patent rights of Analog Devices.

FUNCTIONAL BLOCK DIAGRAMS

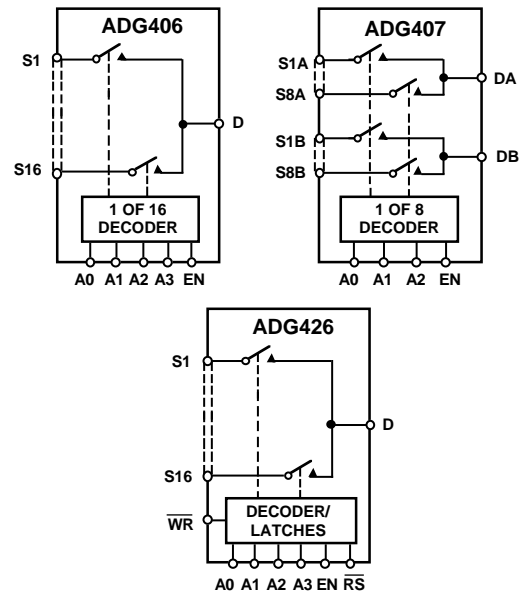

PRODUCT HIGHLIGHTS

1. Extended Signal Range
The ADG406/ADG407/ADG426 are fabricated on an enhanced LC²MOS process giving an increased signal range which extends to the supply rails
2. Low Power Dissipation
3. Low R_{ON}
4. Single/Dual Supply Operation
5. Single Supply Operation
For applications where the analog signal is unipolar, the ADG406/ADG407/ADG426 can be operated from a single rail power supply. The parts are fully specified with a single +12 V power supply and will remain functional with single supplies as low as +5 V.

ADG406/ADG407/ADG426—SPECIFICATIONS¹

DUAL SUPPLY ($V_{DD} = +15\text{ V} \pm 10\%$, $V_{SS} = -15\text{ V} \pm 10\%$, $GND = 0\text{ V}$, unless otherwise noted)

Parameter	B Version		T Version		Units	Test Conditions/Comments
	+25°C	-40°C to +85°C	+25°C	-55°C to +125°C		
ANALOG SWITCH						
Analog Signal Range		V_{SS} to V_{DD}		V_{SS} to V_{DD}	V	
R_{ON}	50		50		Ω typ	$V_D = \pm 10\text{ V}$, $I_S = -1\text{ mA}$
R_{ON} Match	80	125	80	125	Ω max	$V_{DD} = +13.5\text{ V}$, $V_{SS} = -13.5\text{ V}$
	4		4		Ω typ	$V_D = 0\text{ V}$, $I_S = -1\text{ mA}$
LEAKAGE CURRENTS						
Source OFF Leakage I_S (OFF)	± 0.5	± 20	± 0.5	± 50	nA max	$V_{DD} = +16.5\text{ V}$, $V_{SS} = -16.5\text{ V}$
Drain OFF Leakage I_D (OFF)						$V_D = \pm 10\text{ V}$, $V_S = \mp 10\text{ V}$, Test Circuit 2
ADG406, ADG426	± 1	± 20	± 1	± 200	nA max	$V_D = \pm 10\text{ V}$, $V_S = \mp 10\text{ V}$;
ADG407	± 1	± 20	± 1	± 100	nA max	Test Circuit 3
Channel ON Leakage I_D , I_S (ON)						$V_S = V_D = \pm 10\text{ V}$;
ADG406, ADG426	± 1	± 20	± 1	± 200	nA max	Test Circuit 4
ADG407	± 1	± 20	± 1	± 100	nA max	
DIGITAL INPUTS						
Input High Voltage, V_{INH}		2.4		2.4	V min	
Input Low Voltage, V_{INL}		0.8		0.8	V max	
Input Current						
I_{INL} or I_{INH}		± 1		± 1	μA max	$V_{IN} = 0$ or V_{DD}
C_{IN} , Digital Input Capacitance	8		8		pF typ	$f = 1\text{ MHz}$
DYNAMIC CHARACTERISTICS²						
$t_{TRANSITION}$	120		120		ns typ	$R_L = 300\ \Omega$, $C_L = 35\text{ pF}$;
	150	250	150	250	ns max	$V_1 = \pm 10\text{ V}$, $V_2 = \mp 10\text{ V}$;
Break Before Make Delay, t_{OPEN}	10	10	10	10	ns min	Test Circuit 5
t_{ON} (EN , \overline{WR})	120	175	120	175	ns typ	$R_L = 300\ \Omega$, $C_L = 35\text{ pF}$;
	160	225	160	225	ns max	$V_S = +5\text{ V}$, Test Circuit 6
t_{OFF} (EN , \overline{RS})	110	130	110	130	ns typ	$R_L = 300\ \Omega$, $C_L = 35\text{ pF}$;
	150	180	150	180	ns max	$V_S = +5\text{ V}$, Test Circuit 7
ADG426 Only						
t_W , Write Pulse Width		100		100	ns min	
t_{SS} , Address, Enable Setup Time		100		100	ns min	
t_{HH} , Address, Enable Hold Time		10		10	ns min	
t_{RS} , Reset Pulse Width		100		100	ns min	$V_S = +5\text{ V}$
Charge Injection	8		8		pC typ	$V_S = 0\text{ V}$, $R_S = 0\ \Omega$, $C_L = 1\text{ nF}$;
OFF Isolation	-75		-75		dB typ	Test Circuit 10
Channel-to-Channel Crosstalk						$R_L = 1\text{ k}\Omega$, $f = 100\text{ kHz}$;
C_S (OFF)	85		85		dB typ	$V_{EN} = 0\text{ V}$, Test Circuit 11
C_D (OFF)	5		5		pF typ	$R_L = 1\text{ k}\Omega$, $f = 100\text{ kHz}$, Test Circuit 12
ADG406, ADG426						$f = 1\text{ MHz}$
ADG407	50		50		pF typ	$f = 1\text{ MHz}$
C_D , C_S (ON)	25		25		pF typ	
ADG406, ADG426						$f = 1\text{ MHz}$
ADG407	60		60		pF typ	
	40		40		pF typ	
POWER REQUIREMENTS						
I_{DD}		1		1	μA typ	$V_{DD} = +16.5\text{ V}$, $V_{SS} = -16.5\text{ V}$
		5		5	μA max	$V_{IN} = 0\text{ V}$, $V_{EN} = 0\text{ V}$
I_{SS}		1		1	μA typ	
		5		5	μA max	
I_{DD}	100		100		μA typ	$V_{IN} = 0\text{ V}$, $V_{EN} = 2.4\text{ V}$
	200	500	200	500	μA max	
I_{SS}		1		1	μA typ	
		5		5	μA max	

NOTES

¹ Temperature ranges are as follows: B Versions: -40°C to +85°C; T Versions: -55°C to +125°C.

² Guaranteed by design, not subject to production test.

Specifications subject to change without notice.

SINGLE SUPPLY ($V_{DD} = +12\text{ V} \pm 10\%$, $V_{SS} = 0\text{ V}$, $GND = 0\text{ V}$, unless otherwise noted)

Parameter	B Version		T Version		Units	Test Conditions/Comments
	+25°C	-40°C to +85°C	+25°C	-55°C to +125°C		
ANALOG SWITCH						
Analog Signal Range		0 to V_{DD}		0 to V_{DD}	V	
R_{ON}	90 125	200	90 125	200	Ω typ Ω max	$V_D = +3\text{ V}$, $+8.5\text{ V}$, $I_S = -1\text{ mA}$; $V_{DD} = +10.8\text{ V}$
LEAKAGE CURRENTS						
Source OFF Leakage I_S (OFF)	± 0.5	± 20	± 0.5	± 50	nA max	$V_{DD} = +13.2\text{ V}$ $V_D = 8\text{ V}/0.1\text{ V}$, $V_S = 0.1\text{ V}/8\text{ V}$; Test Circuit 2
Drain OFF Leakage I_D (OFF)					nA max	$V_D = 8\text{ V}/0.1\text{ V}$, $V_S = 0.1\text{ V}/8\text{ V}$; Test Circuit 3
ADG406, ADG426	± 1	± 20	± 1	± 200	nA max	
ADG407	± 1	± 20	± 1	± 100	nA max	
Channel ON Leakage I_D , I_S (ON)					nA max	$V_S = V_D = 8\text{ V}/0.1\text{ V}$, Test Circuit 4
ADG406, ADG426	± 1	± 20	± 1	± 200	nA max	
ADG407	± 1	± 20	± 1	± 100	nA max	
DIGITAL INPUTS						
Input High Voltage, V_{INH}		2.4		2.4	V min	
Input Low Voltage, V_{INL}		0.8		0.8	V max	
Input Current					μA max	$V_{IN} = 0$ or V_{DD}
I_{INL} or I_{INH}		± 1		± 1	μA max	$f = 1\text{ MHz}$
C_{IN} , Digital Input Capacitance	8		8		pF typ	
DYNAMIC CHARACTERISTICS²						
$t_{TRANSITION}$	180 220	350	180 220	350	ns typ ns max	$R_L = 300\ \Omega$, $C_L = 35\text{ pF}$; $V_1 = 8\text{ V}/0\text{ V}$, $V_2 = 0\text{ V}/8\text{ V}$; Test Circuit 5
Break Before Make Delay, t_{OPEN}	10		10		ns typ	$R_L = 300\ \Omega$, $C_L = 35\text{ pF}$; $V_S = +5\text{ V}$, Test Circuit 6
t_{ON} (EN, \overline{WR})	180 240	350	180 240	350	ns typ ns max	$R_L = 300\ \Omega$, $C_L = 35\text{ pF}$; $V_S = +5\text{ V}$, Test Circuit 7
t_{OFF} (EN, \overline{RS})	135 180	220	135 180	220	ns typ ns max	$R_L = 300\ \Omega$, $C_L = 35\text{ pF}$; $V_S = +5\text{ V}$, Test Circuit 7
ADG426 Only						
t_w , Write Pulse Width		100		100	ns min	$V_S = +5\text{ V}$
t_s , Address, Enable Setup Time		100		100	ns min	
t_H , Address, Enable Hold Time		10		10	ns min	
t_{RS} , Reset Pulse Width		100		100	ns min	
Charge Injection	5		5		pC typ	$V_S = 6\text{ V}$, $R_S = 0\ \Omega$, $C_L = 1\text{ nF}$; Test Circuit 10
OFF Isolation	-75		-75		dB typ	$R_L = 1\text{ k}\Omega$, $f = 100\text{ kHz}$; Test Circuit 11
Channel-to-Channel Crosstalk	85		85		dB typ	$R_L = 1\text{ k}\Omega$, $f = 100\text{ kHz}$; Test Circuit 12
C_S (OFF)	8		8		pF typ	$f = 1\text{ MHz}$
C_D (OFF)					pF typ	$f = 1\text{ MHz}$
ADG406, ADG426	80		80		pF typ	
ADG407	40		40		pF typ	
C_D , C_S (ON)					pF typ	$f = 1\text{ MHz}$
ADG406, ADG426	100		100		pF typ	
ADG407	50		50		pF typ	
POWER REQUIREMENTS						
I_{DD}		1 5		1 5	μA typ μA max	$V_{DD} = +13.2\text{ V}$ $V_{IN} = 0\text{ V}$, $V_{EN} = 0\text{ V}$
I_{DD}	100 200	500	100 200	500	μA typ μA max	$V_{IN} = 0\text{ V}$, $V_{EN} = 2.4\text{ V}$

NOTES

¹Temperature ranges are as follows: B Versions: -40°C to +85°C; T Versions: -55°C to +125°C.

²Guaranteed by design, not subject to production test.

Specifications subject to change without notice.

ADG406/ADG407/ADG426

ABSOLUTE MAXIMUM RATINGS¹

(T_A = +25°C unless otherwise noted)

V _{DD} to V _{SS}	+44 V
V _{DD} to GND	-0.3 V to +25 V
V _{SS} to GND	+0.3 V to -25 V
Analog, Digital Inputs ²	V _{SS} - 2 V to V _{DD} + 2 V or 20 mA, Whichever Occurs First
Continuous Current, S or D	20 mA
Peak Current, S or D	40 mA (Pulsed at 1 ms, 10% Duty Cycle Max)
Operating Temperature Range	
Industrial (B Version)	-40°C to +85°C
Extended (T Version)	-55°C to +125°C
Storage Temperature Range	-65°C to +150°C
Junction Temperature	+150°C
Plastic Package	
θ _{JA} , Thermal Impedance	75°C/W
Lead Temperature, Soldering (10 sec)	+260°C
PLCC Package	
θ _{JA} , Thermal Impedance	80°C/W
Lead Temperature, Soldering	
Vapor Phase (60 sec)	+215°C
Infrared (15 sec)	+220°C
SSOP Package	
θ _{JA} , Thermal Impedance	122°C/W
Lead Temperature, Soldering	
Vapor Phase (60 sec)	+215°C
Infrared (15 sec)	+220°C

NOTES

¹Stresses above those listed under “Absolute Maximum Ratings” may cause permanent damage to the device. This is a stress rating only and functional operation of the device at these or any other conditions above those listed in the operational sections of this specification is not implied. Exposure to absolute maximum rating conditions for extended periods may affect device reliability. Only one absolute maximum rating may be applied at any one time.

²Overvoltages at A, S, D, \overline{WR} or \overline{RS} will be clamped by internal diodes. Current should be limited to the maximum ratings given.

CAUTION

ESD (electrostatic discharge) sensitive device. Electrostatic charges as high as 4000 V readily accumulate on the human body and test equipment and can discharge without detection. Although these devices feature proprietary ESD protection circuitry, permanent damage may occur on devices subjected to high energy electrostatic discharges. Therefore, proper ESD precautions are recommended to avoid performance degradation or loss of functionality.

ORDERING GUIDE

Model	Temperature Range	Package Option*
ADG406BN	-40°C to +85°C	N-28
ADG406BP	-40°C to +85°C	P-28A
ADG407BN	-40°C to +85°C	N-28
ADG407BP	-40°C to +85°C	P-28A
ADG426BN	-40°C to +85°C	N-28
ADG426BRS	-40°C to +85°C	RS-28

*N = Plastic DIP, P = Plastic Leaded Chip Carrier (PLCC), RS = Shrink Small Outline Package (SSOP).



ADG406/ADG407/ADG426

Table I. Truth Table (ADG406)

A3	A2	A1	A0	EN	ON SWITCH
X	X	X	X	0	NONE
0	0	0	0	1	1
0	0	0	1	1	2
0	0	1	0	1	3
0	0	1	1	1	4
0	1	0	0	1	5
0	1	0	1	1	6
0	1	1	0	1	7
0	1	1	1	1	8
1	0	0	0	1	9
1	0	0	1	1	10
1	0	1	0	1	11
1	0	1	1	1	12
1	1	0	0	1	13
1	1	0	1	1	14
1	1	1	0	1	15
1	1	1	1	1	16

Table II. Truth Table (ADG407)

A2	A1	A0	EN	ON SWITCH PAIR
X	X	X	0	NONE
0	0	0	1	1
0	0	1	1	2
0	1	0	1	3
0	1	1	1	4
1	0	0	1	5
1	0	1	1	6
1	1	0	1	7
1	1	1	1	8

Table III. Truth Table (ADG426)

A3	A2	A1	A0	EN	WR	RS	ON SWITCH
X	X	X	X	X	\bar{f}	1	Retains Previous Switch Condition
X	X	X	X	X	X	0	NONE (Address and Enable Latches Cleared)
X	X	X	X	0	0	1	NONE
0	0	0	0	1	0	1	1
0	0	0	1	1	0	1	2
0	0	1	0	1	0	1	3
0	0	1	1	1	0	1	4
0	1	0	0	1	0	1	5
0	1	0	1	1	0	1	6
0	1	1	0	1	0	1	7
0	1	1	1	1	0	1	8
1	0	0	0	1	0	1	9
1	0	0	1	1	0	1	10
1	0	1	0	1	0	1	11
1	0	1	1	1	0	1	12
1	1	0	0	1	0	1	13
1	1	0	1	1	0	1	14
1	1	1	0	1	0	1	15
1	1	1	1	1	0	1	16

PIN CONFIGURATIONS

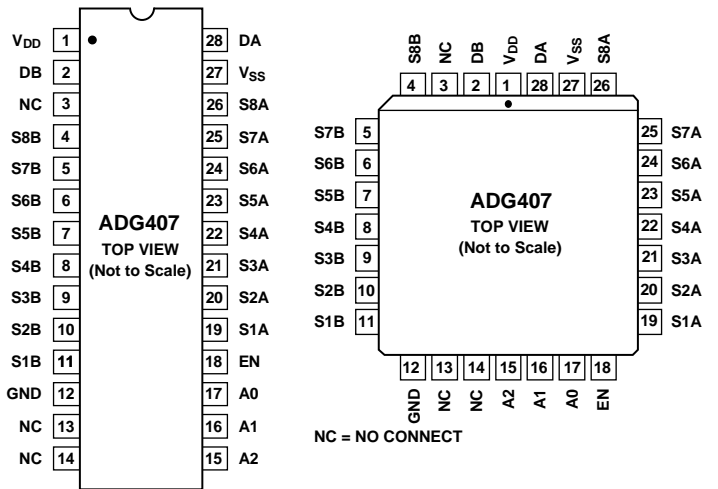
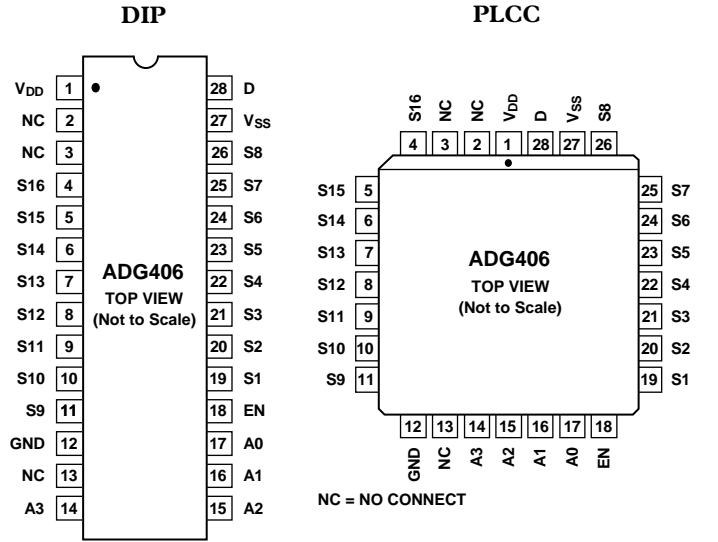

**PIN CONFIGURATION
DIP/SSOP**

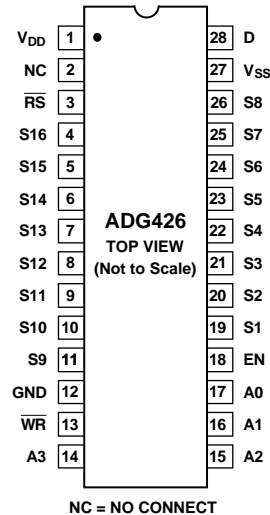

ADG406/ADG407/ADG426

TIMING DIAGRAMS (ADG426)

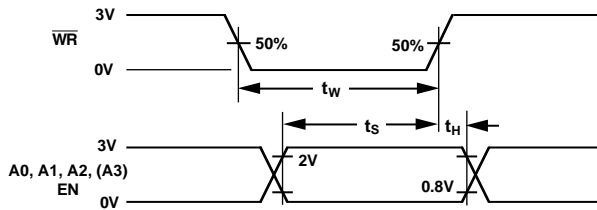

Figure 1.

Figure 1 shows the timing sequence for latching the switch address and enable inputs. The latches are level sensitive; therefore, while \overline{WR} is held low, the latches are transparent and the switches respond to the address and enable inputs. This input data is latched on the rising edge of \overline{WR} .

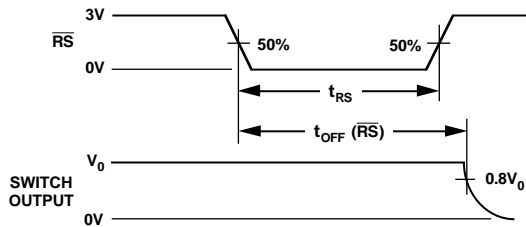

Figure 2.

Figure 2 shows the Reset Pulse Width, t_{RS} , and the Reset Turn Off Time, $t_{OFF}(\overline{RS})$.

Note: All digital input signals rise and fall times are measured from 10% to 90% of 3 V. $t_R = t_F = 20$ ns.

TERMINOLOGY

V_{DD}	Most positive power supply potential.
V_{SS}	Most negative power supply potential in dual supplies. In single supply applications, it may be connected to ground.
GND	Ground (0 V) reference.
R_{ON}	Ohmic resistance between D and S.
$R_{ON\ Match}$	Difference between the R_{ON} of any two channels.
I_S (OFF)	Source leakage current when the switch is off.
I_D (OFF)	Drain leakage current when the switch is off.
I_D, I_S (ON)	Channel leakage current when the switch is on.
V_D (V_S)	Analog voltage on terminals D, S.
C_S (OFF)	Channel input capacitance for "OFF" condition.
C_D (OFF)	Channel output capacitance for "OFF" condition.
C_D, C_S (ON)	"ON" switch capacitance.
C_{IN}	Digital input capacitance.
t_{ON} (EN)	Delay time between the 50% and 90% points of the digital input and switch "ON" condition.
t_{OFF} (EN)	Delay time between the 50% and 90% points of the digital input and switch "OFF" condition.
$t_{TRANSITION}$	Delay time between the 50% and 90% points of the digital inputs and the switch "ON" condition when switching from one address state to another.
t_{OPEN}	"OFF" time measured between 80% points of both switches when switching from one address state to another.
V_{INL}	Maximum input voltage for logic "0."
V_{INH}	Minimum input voltage for logic "1."
I_{INL} (I_{INH})	Input current of the digital input.
Crosstalk	A measure of unwanted signal which is coupled through from one channel to another as a result of parasitic capacitance.
Off Isolation	A measure of unwanted signal coupling through an "OFF" channel.
Charge Injection	A measure of the glitch impulse transferred from the digital input to the analog output during switching.
I_{DD}	Positive supply current.
I_{SS}	Negative supply current.

Typical Performance Graphs

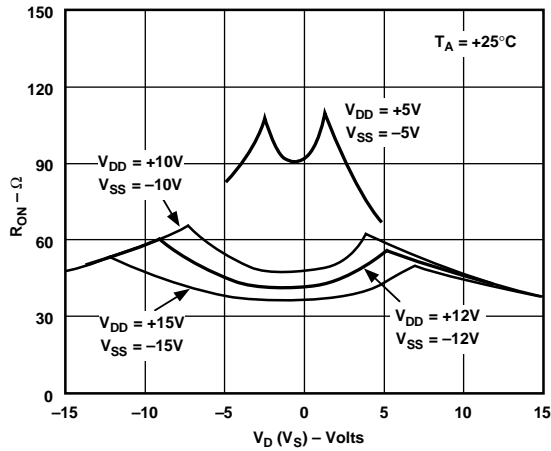

Figure 3. R_{ON} as a Function of V_D (V_S): Dual Supplies

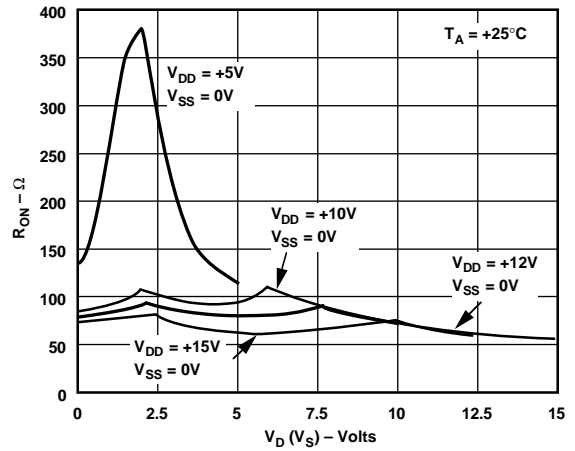

Figure 6. R_{ON} as a Function of V_D (V_S): Single Supplies

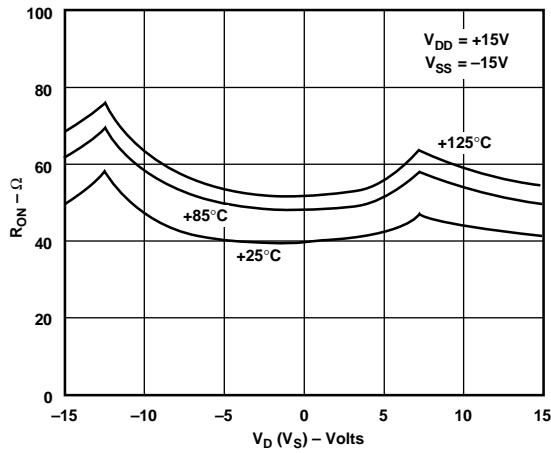

Figure 4. R_{ON} as a Function of V_D (V_S) for Different Temperatures

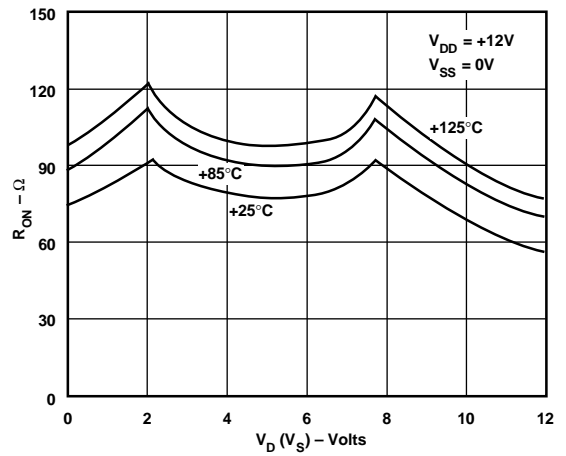

Figure 7. R_{ON} as a Function of V_D (V_S) for Different Temperatures

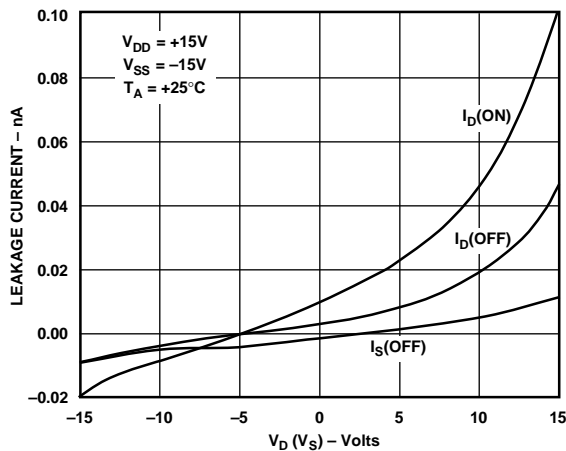

Figure 5. Leakage Currents as a Function of V_D (V_S)

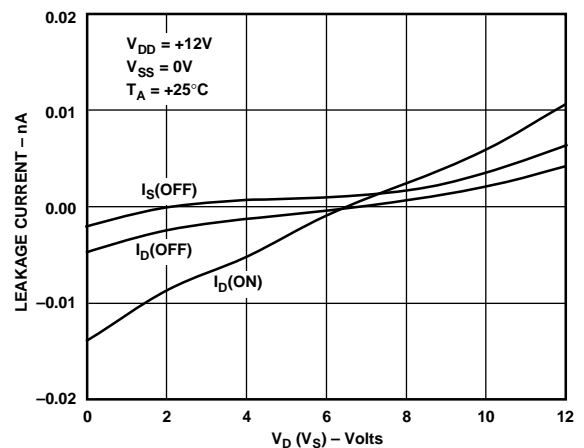

Figure 8. Leakage Currents as a Function of V_D (V_S)

ADG406/ADG407/ADG426

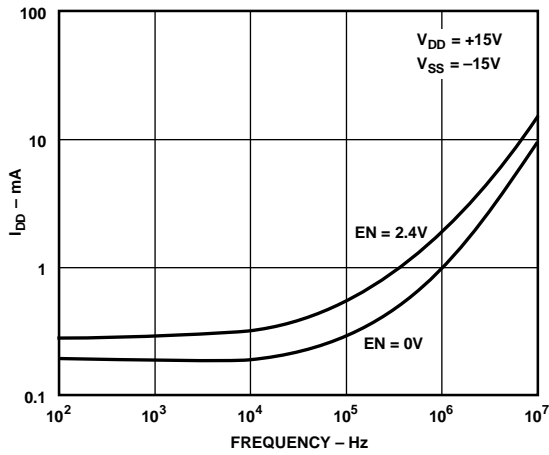

Figure 9. Positive Supply Current vs. Switching Frequency

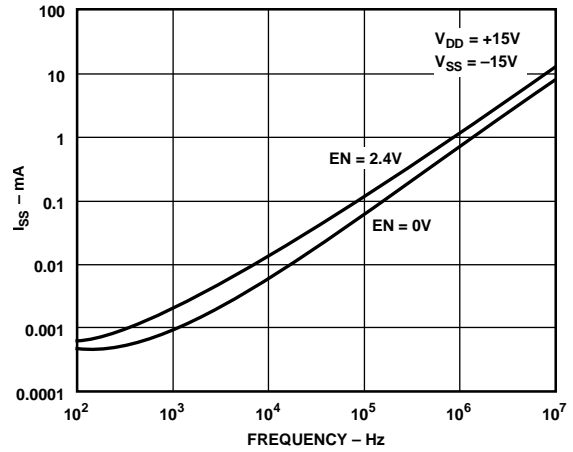

Figure 12. Negative Supply Current vs. Switching Frequency

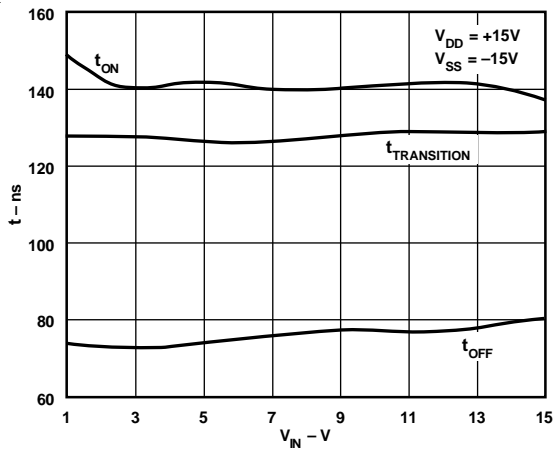

Figure 10. Switching Time vs. V_{IN} (Bipolar Supply)

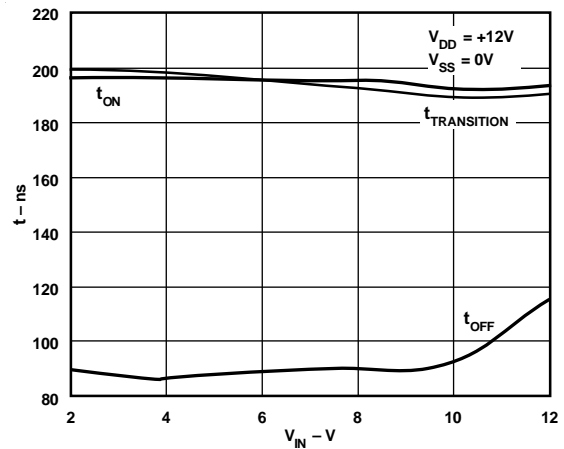

Figure 13. Switching Time vs. V_{IN} (Single Supply)

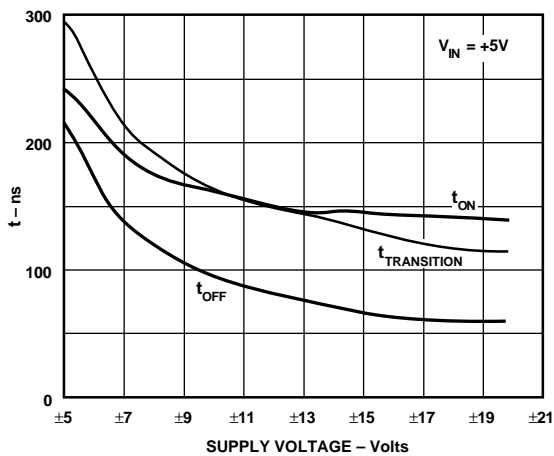

Figure 11. Switching Time vs. Bipolar Supply

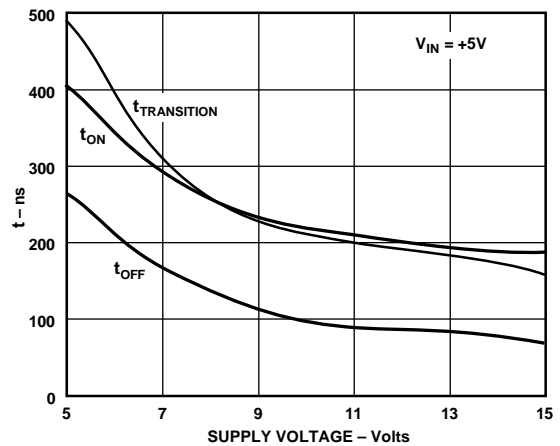

Figure 14. Switching Time vs. Single Supply

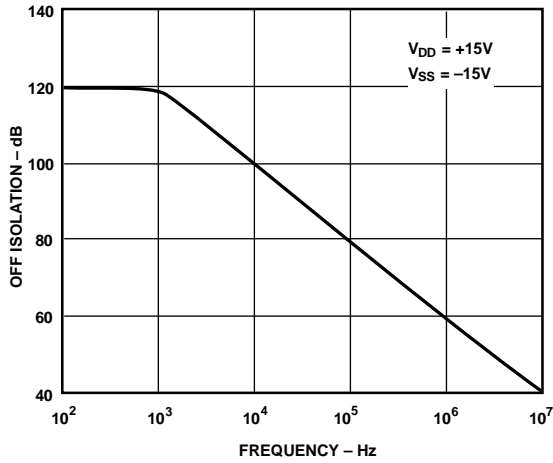

Figure 15. OFF Isolation vs. Frequency

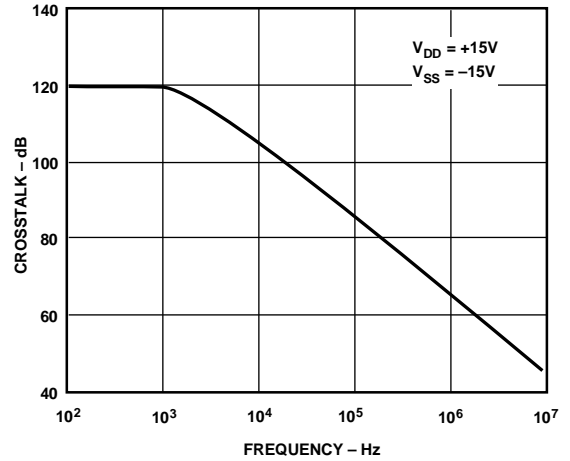
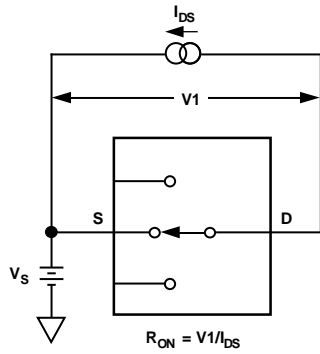
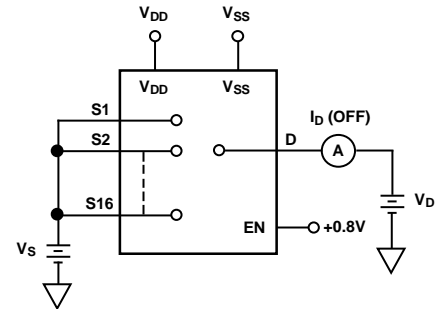

Figure 16. Crosstalk vs. Frequency

Test Circuits



Test Circuit 1. On Resistance



Test Circuit 3. I_D (OFF)

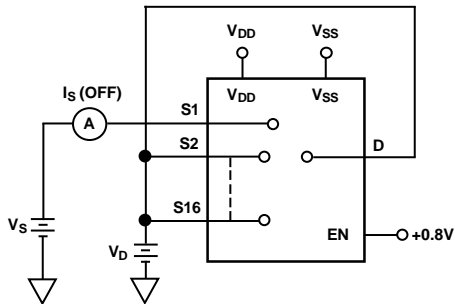

Test Circuit 2. I_S (OFF)

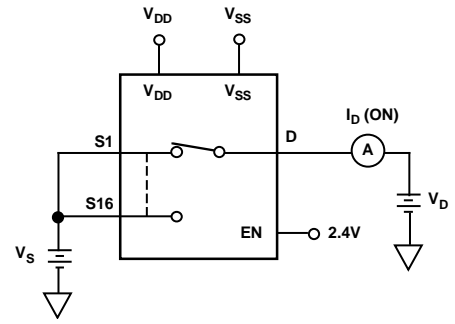

Test Circuit 4. I_D (ON)

ADG406/ADG407/ADG426

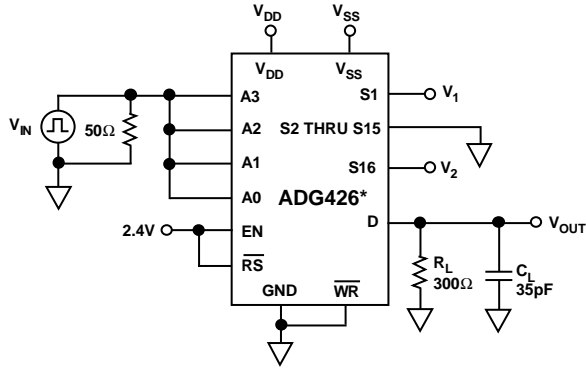

*SIMILAR CONNECTION FOR ADG406/ADG407

Test Circuit 5. Switching Time of Multiplexer, $t_{\text{TRANSITION}}$

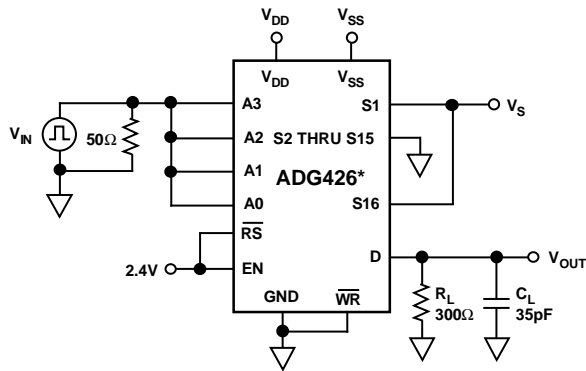
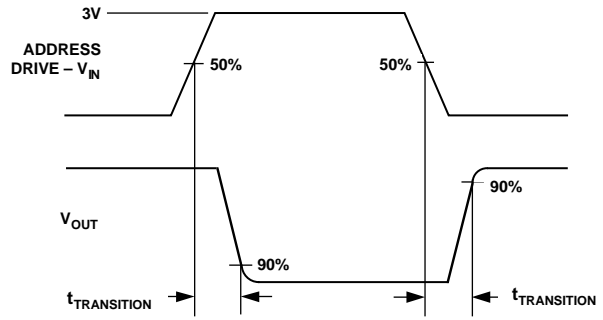

*SIMILAR CONNECTION FOR ADG406/ADG407

Test Circuit 6. Break-Before-Make Delay, t_{OPEN}

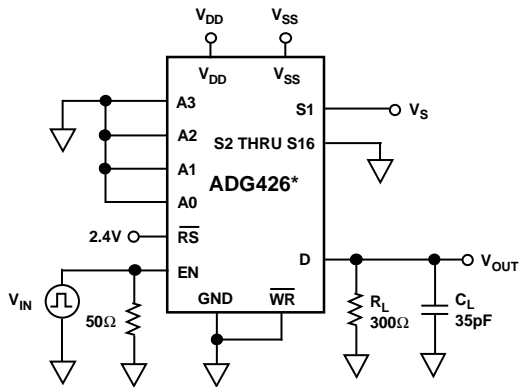
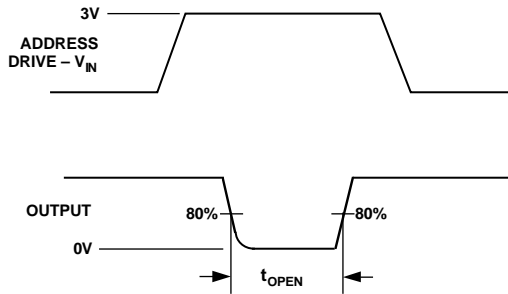

*SIMILAR CONNECTION FOR ADG406/ADG407

Test Circuit 7. Enable Delay, $t_{\text{ON}}(\text{EN})$, $t_{\text{OFF}}(\text{EN})$

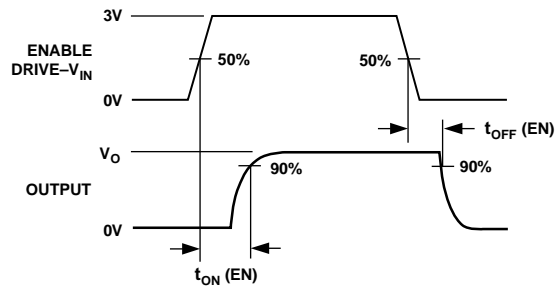

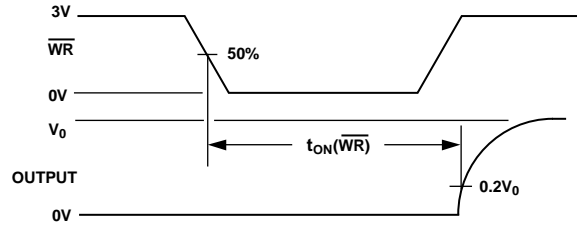
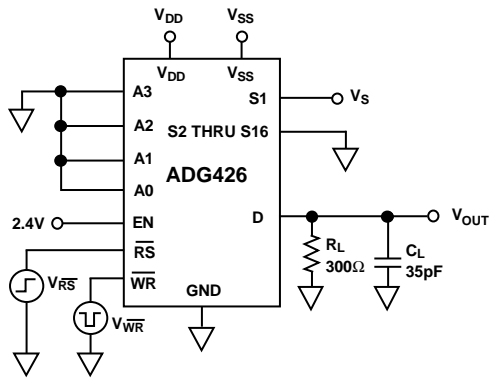

Test Circuit 8. Write Turn-On Time, $t_{ON}(\overline{WR})$

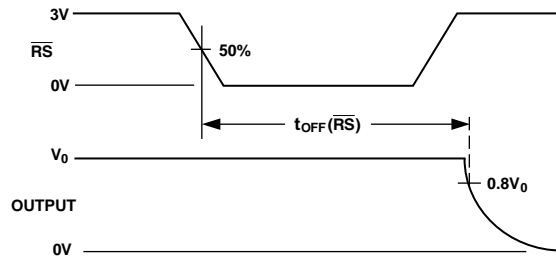
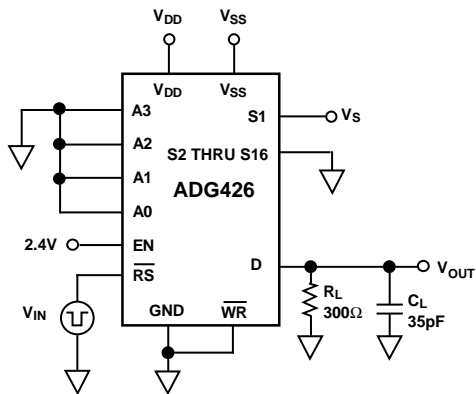

Test Circuit 9. Reset Turn-Off Time, $t_{OFF}(\overline{RS})$

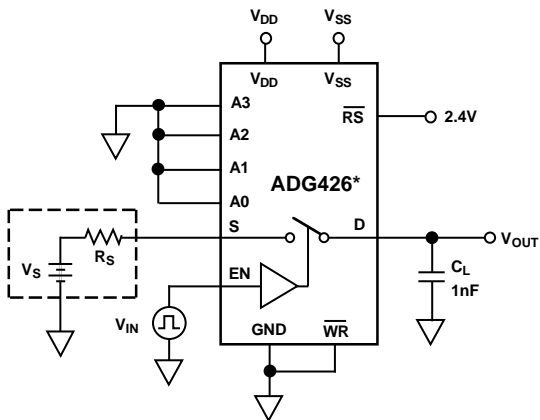

*SIMILAR CONNECTION FOR ADG406/ADG407

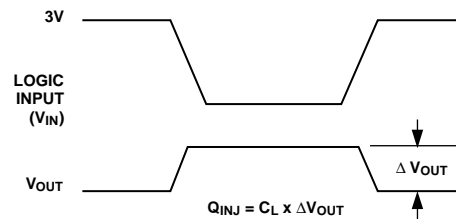

Test Circuit 10. Charge Injection

ADG406/ADG407/ADG426

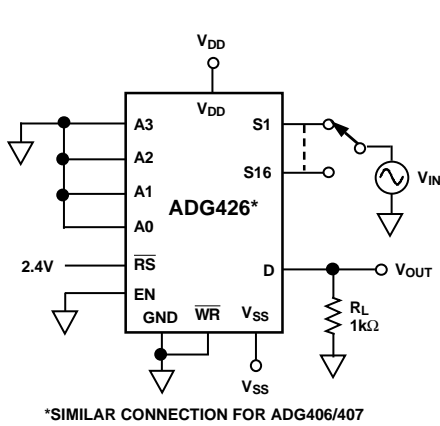

Test Circuit 11. OFF Isolation

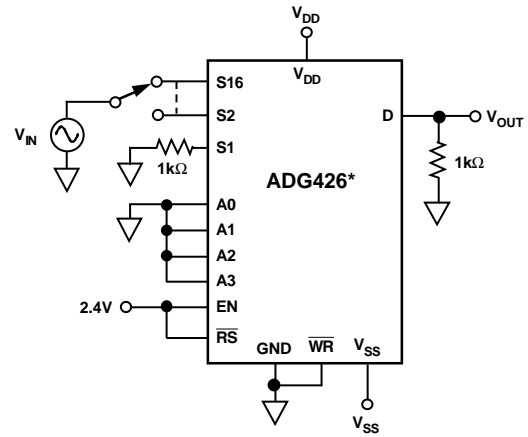

Test Circuit 12. Crosstalk

OUTLINE DIMENSIONS

Dimensions shown in inches and (mm).

28-Pin Plastic (N-28)

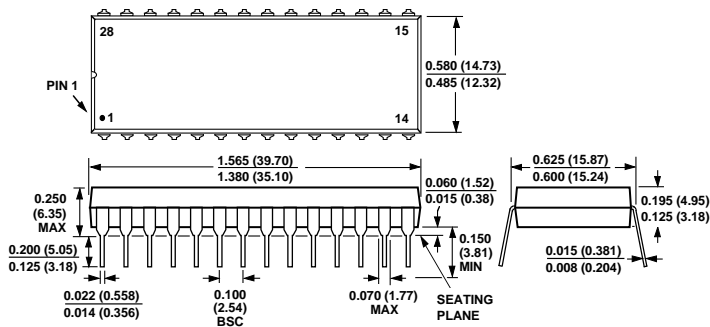

28-Pin PLCC (P-28A)

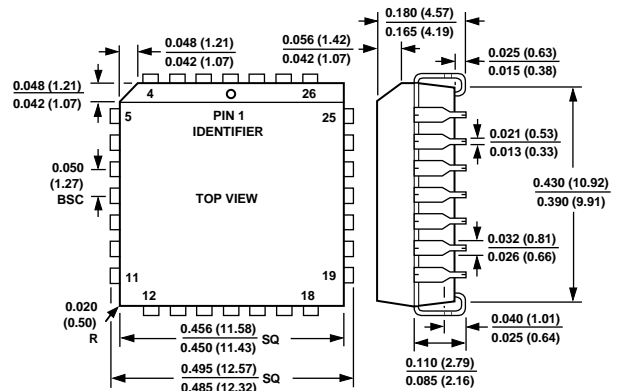

28-Pin SSOP (RS-28)

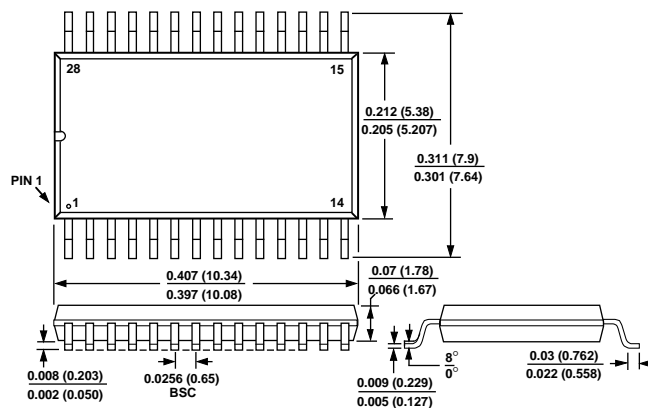

1. LEAD NO. 1 IDENTIFIED BY A DOT.
2. LEADS WILL BE EITHER TIN PLATED OR SOLDER DIPPED IN ACCORDANCE WITH MIL-M-38510 REQUIREMENTS