

## ADM6315

### FEATURES

- Superior Upgrade for MAX6315
- Specified Over Temperature
- Low Power Consumption (5  $\mu$ A Typ)
- Precision Voltage Monitor of Voltages from 2.5 V to 5 V at 100 mV Increments
- Reset Assertion Down to  $V_{CC} > 1$  V
- Built-In Manual Reset
- Pin Compatible with the ADM811

### APPLICATIONS

- Microprocessor Systems
- Controllers
- Intelligent Instruments
- Automotive Systems
- Safety Systems
- Portable Instruments

### GENERAL DESCRIPTION

The ADM6315 is a reliable voltage monitoring device that is suitable for use in most voltage monitoring applications.

The ADM6315 is designed to monitor as little as a 1.8% degradation of a power supply voltage. Voltages that can be monitored by the ADM6315 are all voltages (at 100 mV increments) from 2.5 V to 5 V.

Included in this circuit is a debounced Manual Reset input. Reset can be activated using an ordinary switch (pulling  $\overline{MR}$  low), by a low input from another digital device or by a degradation of the supply voltage. The manual reset function is very useful, especially if the circuit in which the ADM6315 is operating, enters into a state that can only be detected by the user. Allowing the user to manually reset a system can reduce the damage or danger that could be otherwise caused by an out of control or locked-up system.

The ADM6315 comes in a cost and space efficient SOT-143 package.

### FUNCTIONAL BLOCK DIAGRAM

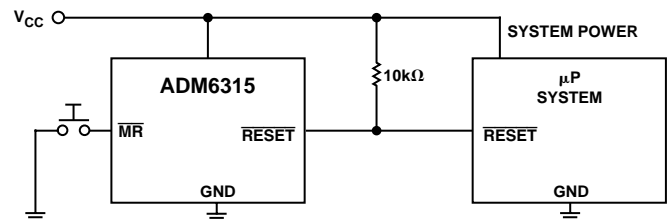
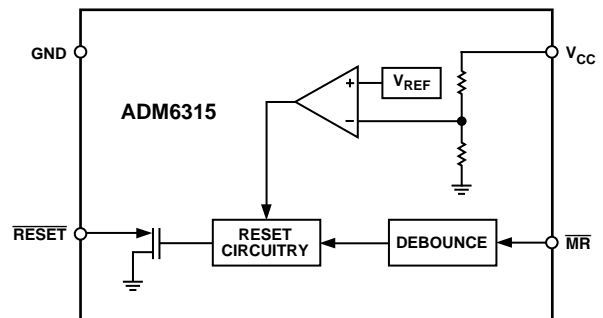

Figure 1. Typical Operating Circuit

### REV. 0

Information furnished by Analog Devices is believed to be accurate and reliable. However, no responsibility is assumed by Analog Devices for its use, nor for any infringements of patents or other rights of third parties which may result from its use. No license is granted by implication or otherwise under any patent or patent rights of Analog Devices.

# ADM6315—SPECIFICATIONS (V<sub>CC</sub> = Full Operating Range, T<sub>A</sub> = T<sub>MIN</sub> to T<sub>MAX</sub>, V<sub>CC</sub> Typ = 5 V unless otherwise noted)

Parameter	Min	Typ	Max	Units	Test Conditions/Comments
<b>SUPPLY</b>					
Operating Voltage	1.0		5.5	V	T <sub>A</sub> = 0°C to +70°C
V <sub>CC</sub> Supply Current		5	12	μA	V <sub>CC</sub> = 5.5 V (No Load)
		4	12	μA	V <sub>CC</sub> = 3.6 V (No Load)
RESET VOLTAGE THRESHOLD (V <sub>TH</sub> ) <sup>1</sup>	V <sub>TH</sub> - 1.8%	V <sub>TH</sub>	V <sub>TH</sub> + 1.8%	V	T <sub>A</sub> = +25°C
	V <sub>TH</sub> - 2.5%		V <sub>TH</sub> + 2.5%	V	T <sub>A</sub> = 0°C to +70°C
RESET THRESHOLD TEMPERATURE COEFFICIENT		60		ppm/°C	
V <sub>CC</sub> TO RESET DELAY		35		μs	V <sub>CC</sub> = Falling at 1 mV/μs
RESET ACTIVE TIMEOUT PERIOD	1	1.4	2.6	ms	ADM6315xxD1
	20	28	53	ms	ADM6315xxD2
	140	200	370	ms	ADM6315xxD3
	1120	1570	2960	ms	ADM6315xxD4
<b>MANUAL RESET</b>					
Input Threshold	0.8			V	V <sub>TH</sub> > 4.0 V (V <sub>IL</sub> )
			2.4	V	V <sub>TH</sub> > 4.0 V (V <sub>IH</sub> )
	0.3 V <sub>CC</sub>			V	V <sub>TH</sub> < 4.0 V (V <sub>IL</sub> )
			0.7 V <sub>CC</sub>	V	V <sub>TH</sub> < 4.0 V (V <sub>IH</sub> )
Minimum Input Pulse	1			μs	
Glitch Rejection		100		ns	
To Reset Delay		500		ns	
Pull-Up Resistance	32	63	100	kΩ	
<b>RESET OUTPUT</b>					
Output Voltage			0.4	V	V <sub>CC</sub> > 4.25 V, I <sub>SINK</sub> = 3.2 mA
			0.3	V	V <sub>CC</sub> > 2.5 V, I <sub>SINK</sub> = 1.2 mA
			0.3	V	V <sub>CC</sub> > 1 V, I <sub>SINK</sub> = 80 mA
Output Leakage Current			1	μA	V <sub>CC</sub> > V <sub>TH</sub> , RESET Deasserted

## NOTES

<sup>1</sup>The ADM6315 is available with preset reset threshold values from 2.5 V to 5 V at 100 mV increments.

Specifications subject to change without notice.

## ABSOLUTE MAXIMUM RATINGS\*

(T<sub>A</sub> = +25°C unless otherwise noted)

### Terminal Voltage (With Respect to Ground)

V<sub>CC</sub> ..... -0.3 V to +6 V

All Other Inputs ..... -0.3 V to V<sub>CC</sub> + 0.3 V

### Input Current

V<sub>CC</sub> ..... 20 mA

### Output Current

$\overline{\text{RESET}}$  ..... 20 mA

### Power Dissipation (T<sub>A</sub> = +70°C)

RT-4, SOT-143

Derate by 4 mW/°C above +70°C ..... 320 mW

θ<sub>JA</sub> Thermal Impedance ..... 330°C/W

Operating Temperature Range ..... -40°C to +85°C

Storage Temperature Range ..... -65°C to +160°C

Lead Temperature (Soldering, 10 secs) ..... +300°C

Vapor Phase (60 sec) ..... +215°C

Infrared (15 sec) ..... +220°C

ESD Rating ..... 2.5 kV

\*Stresses above those listed under Absolute Maximum Ratings may cause permanent damage to the device. This is a stress rating only; functional operation of the device at these or any other conditions above those listed in the operational sections of this specification is not implied. Exposure to absolute maximum ratings for extended periods of time may affect device reliability.

## PIN CONFIGURATION

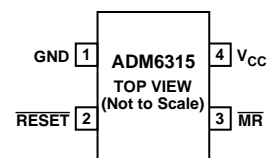

## PIN FUNCTION DESCRIPTIONS

Pin	Mnemonic	Function
1	GND	0 V. Ground reference for all signals.
2	$\overline{\text{RESET}}$	Active Low Logic Output. $\overline{\text{RESET}}$ remains low while V <sub>CC</sub> is below the reset threshold or when $\overline{\text{MR}}$ is low, $\overline{\text{RESET}}$ then remains low for either 1 ms (min), 20 ms (min), 140 ms (min) or 1120 ms (min) after V <sub>CC</sub> rises above the reset threshold and $\overline{\text{MR}}$ is high.
3	$\overline{\text{MR}}$	Manual Reset. This active low de-bounced input will ignore input pulses of 100 ns (typical) and is guaranteed to accept input pulses of greater than 1 μs. Leave floating when not used.
4	V <sub>CC</sub>	Monitored supply voltage.

## ORDERING GUIDE

Model	Temperature Range	Package Description	Package Option
ADM6315-xxxxxxx-xx*	-40°C to +85°C	Plastic Surface Mount	SOT-143

\*Refer to Tables I to IV.

# ADM6315—Typical Performance Characteristics

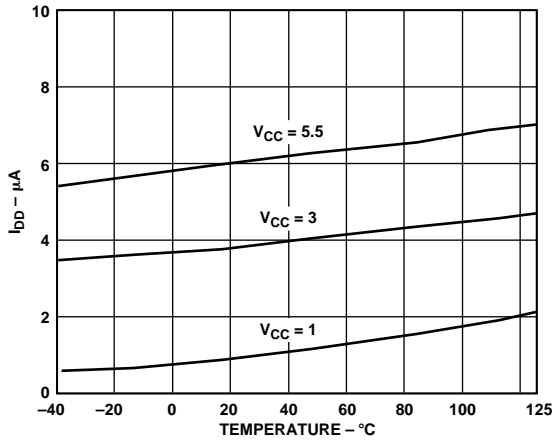

Figure 2. Supply Current vs. Temperature

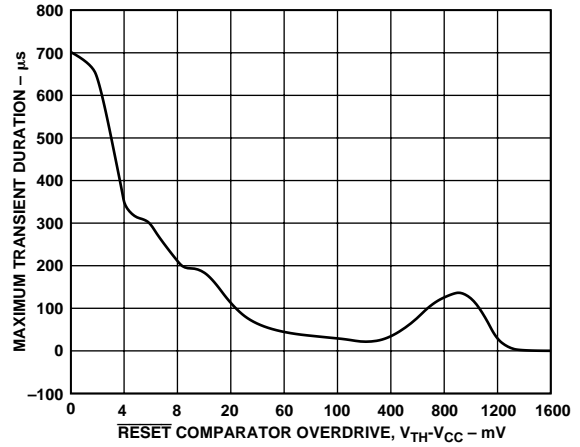

Figure 5. Maximum Transient Duration vs.  $\overline{\text{RESET}}$  Comparator Overdrive

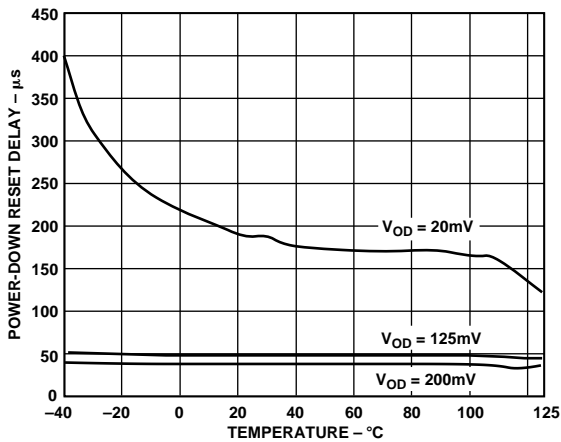

Figure 3. Power-Down Reset Delay vs. Temperature

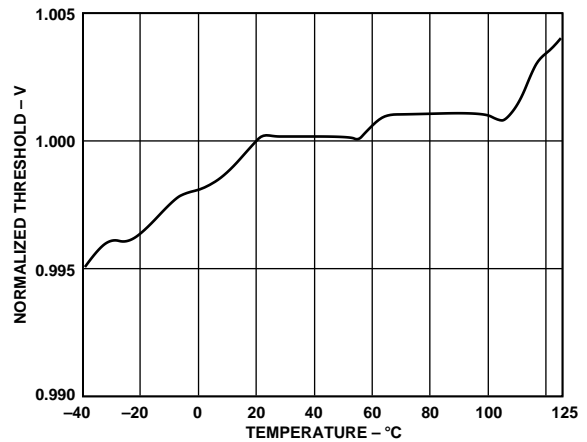

Figure 6. Normalized Reset Threshold vs. Temperature ( $V_{CC}$  Falling)

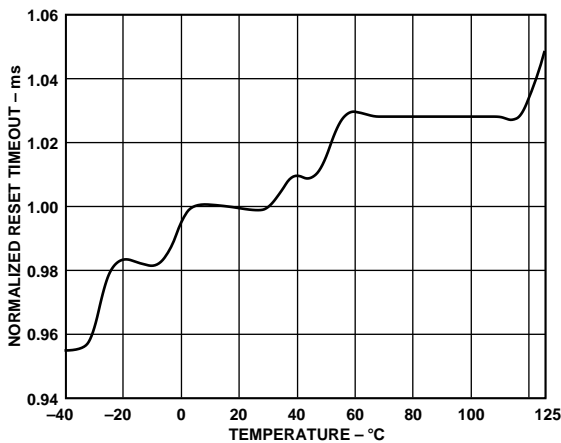

Figure 4. Normalized Reset Timeout Period vs. Temperature ( $V_{CC}$  Rising)

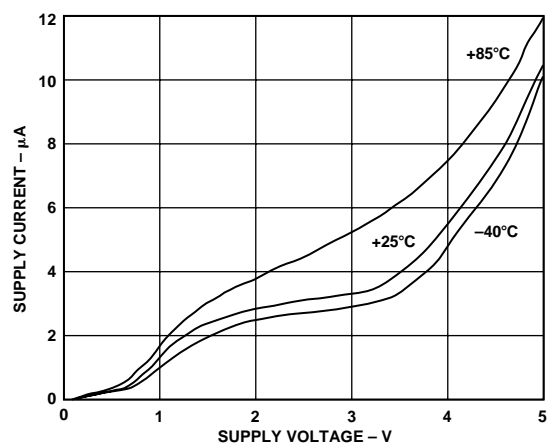

Figure 7. Supply Current vs. Supply Voltage

## INTERFACING TO OTHER DEVICES

### OUTPUT

The ADM6315 series is designed to integrate with as many devices as possible. One feature of the ADM6315 is the  $\overline{\text{RESET}}$  open drain output, which can sink current from sources with a voltage greater than the  $V_{CC}$  of the ADM6315 input making it suitable for use in more diverse applications.

### THE BENEFITS OF A VERY ACCURATE RESET THRESHOLD

Because the ADM6315 series can operate effectively even when there are large degradations of the supply voltages (due to an accurate internal voltage reference circuit), the possibility of a malfunction during a power failure is greatly reduced.

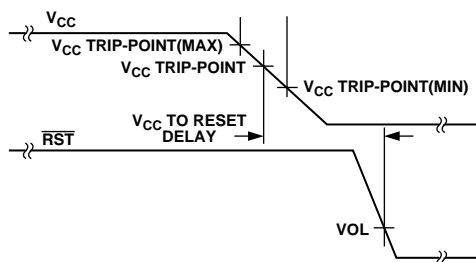

Figure 8.  $V_{CC}$  Power-Down/Brownout Timing Diagram

### DETAILED DESCRIPTION

The ADM6315 is designed to protect the integrity of a systems operation by ensuring the proper operation of the system during power-up, power-down and brownout conditions.

When the ADM6315 is powered-up (depending on the selected reset active timeout), the  $\overline{\text{RESET}}$  output of the ADM6315 will remain low for a period typically equalling the Reset Active Timeout Period. This is designed to give the system time to power-up correctly and for the power supply to stabilize before any devices are brought out of reset and allowed to begin executing instructions. Initializing a system in this way provides a more reliable start-up for microprocessor systems.

When a brownout condition occurs (assuming  $V_{CC}$  is falling at  $1 \text{ mV}/\mu\text{s}$ ), the ADM6315 will produce a reset in typically  $35 \mu\text{s}$ . Producing a reset this fast means that the entire system can be reset together before any part of the systems' voltage falls below its recommended operating voltage. This can avoid dangerous and/or erroneous operation of a microprocessor-based system.

### MANUAL RESET INPUT

The ADM6315 also provides an additional input,  $\overline{\text{MR}}$ . This input can be used as either a means for the system operator to manually reset the system via a switch or for a digital circuit to reset the system.

The  $\overline{\text{MR}}$  input will (typical) ignore negative going pulses faster than  $100 \text{ ns}$  and is guaranteed to accept any negative going input pulse of a duration greater than or equal to  $1 \mu\text{s}$ . If  $\overline{\text{MR}}$  is connected to long cables or used in a noisy environment, then placing a  $1 \mu\text{F}$  decoupling capacitor between the  $\overline{\text{MR}}$  input and ground will further improve the glitch immunity of the ADM6315.

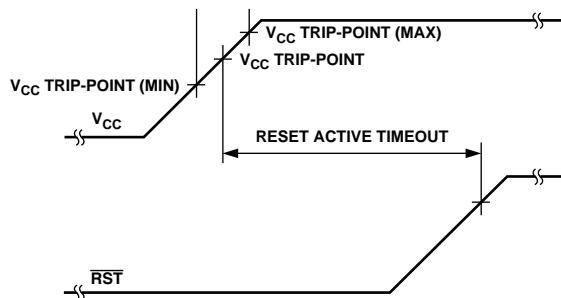

Figure 9.  $V_{CC}$  Power-Up Timing Diagram

### TRANSIENT IMMUNITY

As well as being an accurate reset circuit, the ADM6315 has good immunity to negative going transients (Figure 5). Because of this characteristic, the ADM6315 is suitable for use in noisy environments.

Figure 5 shows the reset comparator overdrive (the maximum magnitude of negative going pulses with respect to the typical reset threshold) versus pulse duration, without causing a reset.

# ADM6315

Table I.

Model*	Trip-Point	Min Timeout (ms)	Brand
ADM6315-50D1ART-RL7	5.00	1	MDZ
ADM6315-50D1ART-RL	5.00	1	MDZ
ADM6315-49D1ART-RL7	4.90	1	MDY
ADM6315-49D1ART-RL	4.90	1	MDY
ADM6315-48D1ART-RL7	4.80	1	MDX
ADM6315-48D1ART-RL	4.80	1	MDX
ADM6315-47D1ART-RL7	4.70	1	MDW
ADM6315-47D1ART-RL	4.70	1	MDW
ADM6315-46D1ART-RL7	4.63	1	MDV
ADM6315-46D1ART-RL	4.63	1	MDV
ADM6315-45D1ART-RL7	4.50	1	MDU
ADM6315-45D1ART-RL	4.50	1	MDU
ADM6315-44D1ART-RL7	4.39	1	MDT
ADM6315-44D1ART-RL	4.39	1	MDT
ADM6315-43D1ART-RL7	4.30	1	MDS
ADM6315-43D1ART-RL	4.30	1	MDS
ADM6315-42D1ART-RL7	4.20	1	MDR
ADM6315-42D1ART-RL	4.20	1	MDR
ADM6315-41D1ART-RL7	4.10	1	MDQ
ADM6315-41D1ART-RL	4.10	1	MDQ
ADM6315-40D1ART-RL7	4.00	1	MDP
ADM6315-40D1ART-RL	4.00	1	MDP
ADM6315-39D1ART-RL7	3.90	1	MDO
ADM6315-39D1ART-RL	3.90	1	MDO
ADM6315-38D1ART-RL7	3.80	1	MDN
ADM6315-38D1ART-RL	3.80	1	MDN
ADM6315-37D1ART-RL7	3.70	1	MDM
ADM6315-37D1ART-RL	3.70	1	MDM
ADM6315-36D1ART-RL7	3.60	1	MDL
ADM6315-36D1ART-RL	3.60	1	MDL
ADM6315-35D1ART-RL7	3.50	1	MDK
ADM6315-35D1ART-RL	3.50	1	MDK
ADM6315-34D1ART-RL7	3.40	1	MDJ
ADM6315-34D1ART-RL	3.40	1	MDJ
ADM6315-33D1ART-RL7	3.30	1	MDI
ADM6315-33D1ART-RL	3.30	1	MDI
ADM6315-32D1ART-RL7	3.20	1	MDH
ADM6315-32D1ART-RL	3.20	1	MDH
ADM6315-31D1ART-RL7	3.08	1	MDG
ADM6315-31D1ART-RL	3.08	1	MDG
ADM6315-30D1ART-RL7	3.00	1	MDF
ADM6315-30D1ART-RL	3.00	1	MDF
ADM6315-29D1ART-RL7	2.93	1	MDE
ADM6315-29D1ART-RL	2.93	1	MDE
ADM6315-28D1ART-RL7	2.80	1	MDD
ADM6315-28D1ART-RL	2.80	1	MDD
ADM6315-27D1ART-RL7	2.70	1	MDC
ADM6315-27D1ART-RL	2.70	1	MDC
ADM6315-26D1ART-RL7	2.63	1	MDB
ADM6315-26D1ART-RL	2.63	1	MDB
ADM6315-25D1ART-RL7	2.50	1	MDA
ADM6315-25D1ART-RL	2.50	1	MDA

Table II.

Model*	Trip-Point	Min Timeout (ms)	Brand
ADM6315-50D2ART-RL7	5.00	20	MEZ
ADM6315-50D2ART-RL	5.00	20	MEZ
ADM6315-49D2ART-RL7	4.90	20	MEY
ADM6315-49D2ART-RL	4.90	20	MEY
ADM6315-48D2ART-RL7	4.80	20	MEX
ADM6315-48D2ART-RL	4.80	20	MEX
ADM6315-47D2ART-RL7	4.70	20	MEW
ADM6315-47D2ART-RL	4.70	20	MEW
ADM6315-46D2ART-RL7	4.63	20	MEV
ADM6315-46D2ART-RL	4.63	20	MEV
ADM6315-45D2ART-RL7	4.50	20	MEU
ADM6315-45D2ART-RL	4.50	20	MEU
ADM6315-44D2ART-RL7	4.39	20	MET
ADM6315-44D2ART-RL	4.39	20	MET
ADM6315-43D2ART-RL7	4.30	20	MES
ADM6315-43D2ART-RL	4.30	20	MES
ADM6315-42D2ART-RL7	4.20	20	MER
ADM6315-42D2ART-RL	4.20	20	MER
ADM6315-41D2ART-RL7	4.10	20	MEQ
ADM6315-41D2ART-RL	4.10	20	MEQ
ADM6315-40D2ART-RL7	4.00	20	MEP
ADM6315-40D2ART-RL	4.00	20	MEP
ADM6315-39D2ART-RL7	3.90	20	MEO
ADM6315-39D2ART-RL	3.90	20	MEO
ADM6315-38D2ART-RL7	3.80	20	MEN
ADM6315-38D2ART-RL	3.80	20	MEN
ADM6315-37D2ART-RL7	3.70	20	MEM
ADM6315-37D2ART-RL	3.70	20	MEM
ADM6315-36D2ART-RL7	3.60	20	MEL
ADM6315-36D2ART-RL	3.60	20	MEL
ADM6315-35D2ART-RL7	3.50	20	MEK
ADM6315-35D2ART-RL	3.50	20	MEK
ADM6315-34D2ART-RL7	3.40	20	MEJ
ADM6315-34D2ART-RL	3.40	20	MEJ
ADM6315-33D2ART-RL7	3.30	20	MEI
ADM6315-33D2ART-RL	3.30	20	MEI
ADM6315-32D2ART-RL7	3.20	20	MEH
ADM6315-32D2ART-RL	3.20	20	MEH
ADM6315-31D2ART-RL7	3.08	20	MEG
ADM6315-31D2ART-RL	3.08	20	MEG
ADM6315-30D2ART-RL7	3.00	20	MEF
ADM6315-30D2ART-RL	3.00	20	MEF
ADM6315-29D2ART-RL7	2.93	20	MEE
ADM6315-29D2ART-RL	2.93	20	MEE
ADM6315-28D2ART-RL7	2.80	20	MED
ADM6315-28D2ART-RL	2.80	20	MED
ADM6315-27D2ART-RL7	2.70	20	MEC
ADM6315-27D2ART-RL	2.70	20	MEC
ADM6315-26D2ART-RL7	2.63	20	MEB
ADM6315-26D2ART-RL	2.63	20	MEB
ADM6315-25D2ART-RL7	2.50	20	MEA
ADM6315-25D2ART-RL	2.50	20	MEA

NOTES

ADM6315-xxxxxxx-RL7 are in reels of 3,000 pieces.

ADM6315-xxxxxxx-RL are in reels of 10,000 pieces.

\*Only available in reels.

**Table III.**

Model*	Trip-Point	Min Timeout (ms)	Brand
ADM6315-50D3ART-RL7	5.00	140	MFZ
ADM6315-50D3ART-RL	5.00	140	MFZ
ADM6315-49D3ART-RL7	4.90	140	MFY
ADM6315-49D3ART-RL	4.90	140	MFY
ADM6315-48D3ART-RL7	4.80	140	MFY
ADM6315-48D3ART-RL	4.80	140	MFY
ADM6315-47D3ART-RL7	4.70	140	MFX
ADM6315-47D3ART-RL	4.70	140	MFX
ADM6315-46D3ART-RL7	4.63	140	MFX
ADM6315-46D3ART-RL	4.63	140	MFX
<b>ADM6315-45D3ART-RL7</b>	<b>4.50</b>	<b>140</b>	<b>MFU</b>
<b>ADM6315-45D3ART-RL</b>	<b>4.50</b>	<b>140</b>	<b>MFU</b>
ADM6315-44D3ART-RL7	4.39	140	MFT
ADM6315-44D3ART-RL	4.39	140	MFT
ADM6315-43D3ART-RL7	4.30	140	MFT
ADM6315-43D3ART-RL	4.30	140	MFT
ADM6315-42D3ART-RL7	4.20	140	MFS
ADM6315-42D3ART-RL	4.20	140	MFS
ADM6315-41D3ART-RL7	4.10	140	MFR
ADM6315-41D3ART-RL	4.10	140	MFR
ADM6315-40D3ART-RL7	4.00	140	MFQ
ADM6315-40D3ART-RL	4.00	140	MFQ
ADM6315-39D3ART-RL7	3.90	140	MFQ
ADM6315-39D3ART-RL	3.90	140	MFQ
ADM6315-38D3ART-RL7	3.80	140	MFP
ADM6315-38D3ART-RL	3.80	140	MFP
ADM6315-37D3ART-RL7	3.70	140	MFO
ADM6315-37D3ART-RL	3.70	140	MFO
ADM6315-36D3ART-RL7	3.60	140	MFO
ADM6315-36D3ART-RL	3.60	140	MFO
ADM6315-35D3ART-RL7	3.50	140	MFN
ADM6315-35D3ART-RL	3.50	140	MFN
ADM6315-34D3ART-RL7	3.40	140	MFN
ADM6315-34D3ART-RL	3.40	140	MFN
ADM6315-33D3ART-RL7	3.40	140	MFM
ADM6315-33D3ART-RL	3.40	140	MFM
ADM6315-32D3ART-RL7	3.30	140	MFL
ADM6315-32D3ART-RL	3.30	140	MFL
ADM6315-31D3ART-RL7	3.20	140	MFL
ADM6315-31D3ART-RL	3.20	140	MFL
ADM6315-30D3ART-RL7	3.08	140	MFL
ADM6315-30D3ART-RL	3.08	140	MFL
ADM6315-29D3ART-RL7	3.00	140	MFK
ADM6315-29D3ART-RL	3.00	140	MFK
ADM6315-29D3ART-RL7	2.93	140	MFJ
ADM6315-29D3ART-RL	2.93	140	MFJ
ADM6315-28D3ART-RL7	2.80	140	MFJ
ADM6315-28D3ART-RL	2.80	140	MFJ
ADM6315-27D3ART-RL7	2.80	140	MFI
ADM6315-27D3ART-RL	2.80	140	MFI
ADM6315-27D3ART-RL7	2.70	140	MFI
ADM6315-27D3ART-RL	2.70	140	MFI
ADM6315-26D3ART-RL7	2.70	140	MFH
ADM6315-26D3ART-RL	2.70	140	MFH
ADM6315-26D3ART-RL7	2.63	140	MFH
ADM6315-26D3ART-RL	2.63	140	MFH
ADM6315-25D3ART-RL7	2.63	140	MFG
ADM6315-25D3ART-RL	2.63	140	MFG
ADM6315-25D3ART-RL7	2.50	140	MFG
ADM6315-25D3ART-RL	2.50	140	MFG
ADM6315-25D3ART-RL7	2.50	140	MFF
ADM6315-25D3ART-RL	2.50	140	MFF
ADM6315-25D3ART-RL7	2.50	140	MFE
ADM6315-25D3ART-RL	2.50	140	MFE
ADM6315-25D3ART-RL7	2.50	140	MFE
ADM6315-25D3ART-RL	2.50	140	MFE
ADM6315-25D3ART-RL7	2.50	140	MFD
ADM6315-25D3ART-RL	2.50	140	MFD
ADM6315-25D3ART-RL7	2.50	140	MFD
ADM6315-25D3ART-RL	2.50	140	MFD
ADM6315-25D3ART-RL7	2.50	140	MFC
ADM6315-25D3ART-RL	2.50	140	MFC
ADM6315-25D3ART-RL7	2.50	140	MFC
ADM6315-25D3ART-RL	2.50	140	MFC
ADM6315-25D3ART-RL7	2.50	140	MFB
ADM6315-25D3ART-RL	2.50	140	MFB
ADM6315-25D3ART-RL7	2.50	140	MFB
ADM6315-25D3ART-RL	2.50	140	MFB
ADM6315-25D3ART-RL7	2.50	140	MFA
ADM6315-25D3ART-RL	2.50	140	MFA
ADM6315-25D3ART-RL7	2.50	140	MFA
ADM6315-25D3ART-RL	2.50	140	MFA

**Table IV.**

Model*	Trip-Point	Min Timeout (ms)	Brand
ADM6315-50D4ART-RL	5.00	1120	MGZ
ADM6315-50D4ART-RL7	5.00	1120	MGZ
ADM6315-49D4ART-RL	4.90	1120	MGZ
ADM6315-49D4ART-RL7	4.90	1120	MGY
ADM6315-48D4ART-RL	4.80	1120	MGY
ADM6315-48D4ART-RL7	4.80	1120	MGX
ADM6315-47D4ART-RL	4.70	1120	MGX
ADM6315-47D4ART-RL7	4.70	1120	MGW
ADM6315-46D4ART-RL	4.63	1120	MGW
ADM6315-46D4ART-RL7	4.63	1120	MGV
ADM6315-45D4ART-RL	4.50	1120	MGV
ADM6315-45D4ART-RL7	4.50	1120	MGU
ADM6315-44D4ART-RL	4.39	1120	MGU
ADM6315-44D4ART-RL7	4.39	1120	MGT
ADM6315-43D4ART-RL	4.30	1120	MGT
ADM6315-43D4ART-RL7	4.30	1120	MGS
ADM6315-42D4ART-RL	4.20	1120	MGS
ADM6315-42D4ART-RL7	4.20	1120	MGR
ADM6315-41D4ART-RL	4.10	1120	MGR
ADM6315-41D4ART-RL7	4.10	1120	MGQ
ADM6315-40D4ART-RL	4.00	1120	MGQ
ADM6315-40D4ART-RL7	4.00	1120	MGP
ADM6315-39D4ART-RL	4.00	1120	MGP
ADM6315-39D4ART-RL7	3.90	1120	MGO
ADM6315-38D4ART-RL	3.90	1120	MGO
ADM6315-38D4ART-RL7	3.80	1120	MGN
ADM6315-37D4ART-RL	3.80	1120	MGN
ADM6315-37D4ART-RL7	3.70	1120	MGN
ADM6315-36D4ART-RL	3.70	1120	MGM
ADM6315-36D4ART-RL7	3.70	1120	MGM
ADM6315-35D4ART-RL	3.60	1120	MGL
ADM6315-35D4ART-RL7	3.60	1120	MGL
ADM6315-34D4ART-RL	3.50	1120	MGL
ADM6315-34D4ART-RL7	3.50	1120	MGK
ADM6315-33D4ART-RL	3.50	1120	MGK
ADM6315-33D4ART-RL7	3.40	1120	MGJ
ADM6315-32D4ART-RL	3.40	1120	MGJ
ADM6315-32D4ART-RL7	3.40	1120	MGJ
ADM6315-31D4ART-RL	3.30	1120	MGI
ADM6315-31D4ART-RL7	3.30	1120	MGI
ADM6315-30D4ART-RL	3.30	1120	MGI
ADM6315-30D4ART-RL7	3.20	1120	MGI
ADM6315-29D4ART-RL	3.20	1120	MGH
ADM6315-29D4ART-RL7	3.20	1120	MGH
ADM6315-28D4ART-RL	3.08	1120	MGH
ADM6315-28D4ART-RL7	3.08	1120	MGG
ADM6315-27D4ART-RL	3.08	1120	MGG
ADM6315-27D4ART-RL7	3.00	1120	MGG
ADM6315-26D4ART-RL	3.00	1120	MGF
ADM6315-26D4ART-RL7	3.00	1120	MGF
ADM6315-25D4ART-RL	3.00	1120	MGF
ADM6315-25D4ART-RL7	2.93	1120	MGE
ADM6315-24D4ART-RL	2.93	1120	MGE
ADM6315-24D4ART-RL7	2.93	1120	MGE
ADM6315-23D4ART-RL	2.80	1120	MGE
ADM6315-23D4ART-RL7	2.80	1120	MGD
ADM6315-22D4ART-RL	2.80	1120	MGD
ADM6315-22D4ART-RL7	2.80	1120	MGD
ADM6315-21D4ART-RL	2.70	1120	MGC
ADM6315-21D4ART-RL7	2.70	1120	MGC
ADM6315-20D4ART-RL	2.70	1120	MGC
ADM6315-20D4ART-RL7	2.70	1120	MGC
ADM6315-19D4ART-RL	2.63	1120	MGB
ADM6315-19D4ART-RL7	2.63	1120	MGB
ADM6315-18D4ART-RL	2.63	1120	MGB
ADM6315-18D4ART-RL7	2.63	1120	MGB
ADM6315-17D4ART-RL	2.50	1120	MGA
ADM6315-17D4ART-RL7	2.50	1120	MGA
ADM6315-16D4ART-RL	2.50	1120	MGA
ADM6315-16D4ART-RL7	2.50	1120	MGA

**NOTES**

All parts in bold are ex-stock. Consult factory for availability of orders.

ADM6315-xxxxxxx-RL7 are in reels of 3,000 pieces.

ADM6315-xxxxxxx-RL are in reels of 10,000 pieces.

\*Only available in reels.

## OUTLINE DIMENSIONS

Dimensions shown in inches and (mm).

### 4-Lead Plastic Surface Mount Package (SOT-143)

