

ADR293

FEATURES

6.0 V to 15 V Supply Range
Supply Current 15 μ A Max
Low Noise 15 μ V p-p Typ (0.1 Hz to 10 Hz)
High Output Current 5 mA
Temperature Range -40°C to $+125^{\circ}\text{C}$
Pin Compatible with REF02/REF19x

APPLICATIONS

Portable Instrumentation
Precision Reference for 5 V Systems
A/D and D/A Converter Reference
Solar Powered Applications
Loop-Current Powered Instruments

GENERAL DESCRIPTION

The ADR293 is a low noise, micropower precision voltage reference that utilizes an XFET[®] (eXtra implanted junction FET) reference circuit. The new XFET architecture offers significant performance improvements over traditional bandgap and buried Zener-based references. Improvements include: one quarter the voltage noise output of bandgap references operating at the same current, very low and ultralinear temperature drift, low thermal hysteresis and excellent long-term stability.

The ADR293 is a series voltage reference providing stable and accurate output voltage from a 6.0 V supply. Quiescent current is only 15 μ A max, making this device ideal for battery powered instrumentation. Three electrical grades are available offering initial output accuracy of ± 3 mV, ± 6 mV, and ± 10 mV. Temperature coefficients for the three grades are 8 ppm/ $^{\circ}\text{C}$, 15 ppm/ $^{\circ}\text{C}$ and 25 ppm/ $^{\circ}\text{C}$ max. Line regulation and load regulation are typically 30 ppm/V and 30 ppm/mA, maintaining the reference's overall high performance.

The ADR293 is specified over the extended industrial temperature range of -40°C to $+125^{\circ}\text{C}$. This device is available in the 8-lead SOIC and 8-lead TSSOP packages.

PIN CONFIGURATIONS

8-Lead Narrow Body SO (R Suffix)

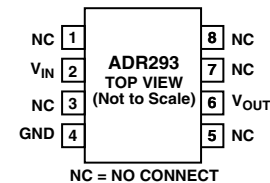

8-Lead TSSOP (RU Suffix)

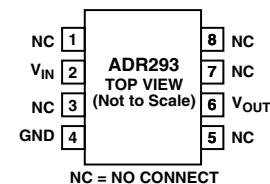

ADR29x Products

Device	Output Voltage (V)	Initial Accuracy (%)	Temperature Coefficient (ppm/ $^{\circ}\text{C}$) Max
ADR290	2.048	(See ADR290/ADR291/ADR292 Data Sheet)	8, 15, 25
ADR291	2.500		
ADR292	4.096		
ADR293	5.000	0.06, 0.12, 0.20	

XFET is a registered trademark of Analog Devices, Inc.

REV. A

Information furnished by Analog Devices is believed to be accurate and reliable. However, no responsibility is assumed by Analog Devices for its use, nor for any infringements of patents or other rights of third parties which may result from its use. No license is granted by implication or otherwise under any patent or patent rights of Analog Devices.

One Technology Way, P.O. Box 9106, Norwood, MA 02062-9106, U.S.A.
Tel: 781/329-4700 **World Wide Web Site: <http://www.analog.com>**
Fax: 781/326-8703 **© Analog Devices, Inc., 2001**

ADR293—SPECIFICATIONS

ELECTRICAL SPECIFICATIONS ($V_S = 6.0\text{ V}$, $T_A = 25^\circ\text{C}$ unless otherwise noted.)

Parameter	Symbol	Conditions	Min	Typ	Max	Unit
INITIAL ACCURACY Output Voltage “E” Grade	V_O	$I_{OUT} = 0\text{ mA}$	4.997	5.000	5.003	V
“F” Grade			-3		+3	mV
“G” Grade					0.06	%
“F” Grade			4.994	5.000	5.006	V
“G” Grade			-6		+6	mV
					0.12	%
			4.990	5.000	5.010	V
			-10		+10	mV
					0.20	%
LINE REGULATION “E/F” Grades “G” Grade	$\Delta V_O/\Delta V_{IN}$	6.0 V to 15 V, $I_{OUT} = 0\text{ mA}$		30	100	ppm/V
				40	150	ppm/V
LOAD REGULATION “E/F” Grades “G” Grade	$\Delta V_O/\Delta I_{LOAD}$	$V_S = 6.0\text{ V}$, 0 mA to 5 mA		30	100	ppm/mA
				40	150	ppm/mA
LONG-TERM STABILITY	ΔV_O	After 1000 hrs of Operation @ 125°C		50		ppm
NOISE VOLTAGE	e_N	0.1 Hz to 10 Hz		15		$\mu\text{V p-p}$
WIDEBAND NOISE DENSITY	e_N	at 1 kHz		640		$\text{nV}/\sqrt{\text{Hz}}$

ELECTRICAL SPECIFICATIONS ($V_S = 6.0\text{ V}$, $T_A = -25^\circ\text{C} \leq T_A \leq +85^\circ\text{C}$ unless otherwise noted.)

Parameter	Symbol	Conditions	Min	Typ	Max	Unit
TEMPERATURE COEFFICIENT “E” Grade “F” Grade “G” Grade	TCV_O	$I_{OUT} = 0\text{ mA}$		3	8	ppm/ $^\circ\text{C}$
				5	15	ppm/ $^\circ\text{C}$
				10	25	ppm/ $^\circ\text{C}$
LINE REGULATION “E/F” Grades “G” Grade	$\Delta V_O/\Delta V_{IN}$	6.0 V to 15 V, $I_{OUT} = 0\text{ mA}$		35	150	ppm/V
				50	200	ppm/V
LOAD REGULATION “E/F” Grades “G” Grade	$\Delta V_O/\Delta I_{LOAD}$	$V_S = 6.0\text{ V}$, 0 mA to 5 mA		20	150	ppm/mA
				30	200	ppm/mA

ELECTRICAL SPECIFICATIONS ($V_S = 6.0\text{ V}$, $T_A = -40^\circ\text{C} \leq T_A \leq +125^\circ\text{C}$ unless otherwise noted.)

Parameter	Symbol	Conditions	Min	Typ	Max	Unit
TEMPERATURE COEFFICIENT “E” Grade “F” Grade “G” Grade	TCV_O	$I_{OUT} = 0\text{ mA}$		3	10	ppm/ $^\circ\text{C}$
				5	20	ppm/ $^\circ\text{C}$
				10	30	ppm/ $^\circ\text{C}$
LINE REGULATION “E/F” Grades “G” Grade	$\Delta V_O/\Delta V_{IN}$	6.0 V to 15 V, $I_{OUT} = 0\text{ mA}$		40	200	ppm/V
				70	250	ppm/V
LOAD REGULATION “E/F” Grades “G” Grade	$\Delta V_O/\Delta I_{LOAD}$	$V_S = 6.0\text{ V}$, 0 mA to 5 mA		20	200	ppm/mA
				30	300	ppm/mA
SUPPLY CURRENT	I_S	@ 25°C		11	15	μA
				15	20	μA
THERMAL HYSTERESIS	V_{O-HYS}	SO-8 TSSOP-8		72		ppm
				157		ppm

Specifications subject to change without notice.

ABSOLUTE MAXIMUM RATINGS¹

Supply Voltage.	18 V
Output Short-Circuit Duration to GND	Indefinite
Storage Temperature Range	
SO, RU Package	−65°C to +150°C
Operating Temperature Range	−40°C to +125°C
Junction Temperature Range	
SO, RU Package	−65°C to +125°C
Lead Temperature (Soldering, 60 sec)	300°C

Package Type	θ_{JA}^*	θ_{JC}	Unit
8-Lead SOIC (SO)	158	43	°C/W
8-Lead TSSOP (RU)	240	43	°C/W

* θ_{JA} is specified for worst-case conditions, i.e., θ_{JA} is specified for device in socket testing; in practice, θ_{JA} is specified for a device soldered in circuit board.

NOTES

¹Stresses above those listed under Absolute Maximum Ratings may cause permanent damage to the device. This is a stress rating only; functional operation of the device at these or any other conditions above those listed in the operational sections of this specification is not implied. Exposure to absolute maximum rating conditions for extended periods may affect device reliability.

²Remove power before inserting or removing units from their sockets.

ORDERING GUIDE

Model	Output Voltage V	Initial Accuracy %	Temperature Coefficient Max ppm/°C	Package Description	Package Option	Number of Parts per Package
ADR293ER, ADR293ER-REEL7, ADR293ER-REEL	5.00	0.06	8	SOIC	SO-8	98, 1000, 2500
ADR293FR, ADR293FR-REEL7, ADR293FR-REEL	5.00	0.12	15	SOIC	SO-8	98, 1000, 2500
ADR293GR, ADR293GR-REEL7, ADR293GR-REEL	5.00	0.20	25	SOIC	SO-8	98, 1000, 2500
ADR293GRU-REEL7, ADR293GRU-REEL	5.00	0.20	25	TSSOP	RU-8	1000, 2500

CAUTION

ESD (electrostatic discharge) sensitive device. Electrostatic charges as high as 4000 V readily accumulate on the human body and test equipment and can discharge without detection. Although the ADR293 features proprietary ESD protection circuitry, permanent damage may occur on devices subjected to high-energy electrostatic discharges. Therefore, proper ESD precautions are recommended to avoid performance degradation or loss of functionality.



ADR293

PARAMETER DEFINITION

Line Regulation, the change in output voltage due to a specified change in input voltage. It includes the effects of self-heating. Line regulation is expressed in either percent-per-volt, parts-per-million-per-volt, or microvolts-per-volt change in input voltage.

Load Regulation, the change in output voltage due to a specified change in load current. It includes the effects of self-heating. Load Regulation is expressed in either microvolts-per-milliamper, parts-per-million-per-milliamper, or ohms of dc output resistance.

Long-Term Stability, typical shift of output voltage of 25°C on a sample of parts subjected to high-temperature operating life test of 1000 hours at 125°C.

$$\Delta V_O = V_O(t_0) - V_O(t_1)$$
$$\Delta V_O [ppm] = \frac{V_O(t_0) - V_O(t_1)}{V_O(t_0)} \times 10^6$$

where:

$$V_O(t_0) = V_O \text{ at } 25^\circ\text{C at time } 0.$$
$$V_O(t_1) = V_O \text{ at } 25^\circ\text{C after 1000 hours operation at } 125^\circ\text{C}.$$

NC = No Connect (There are in fact connections at NC pins which are reserved for manufacturing purposes. Users should not connect anything at NC pins.).

Temperature Coefficient, the change of output voltage over the operating temperature change and normalized by the output voltage at 25°C, expressed in ppm/°C. The equation follows:

$$TCV_O [ppm/^\circ\text{C}] = \frac{V_O(T_2) - V_O(T_1)}{V_O(25^\circ\text{C}) \times (T_2) - (T_1)} \times 10^6$$

where:

$$V_O(25^\circ\text{C}) = V_O \text{ at } 25^\circ\text{C}.$$
$$V_O(T_1) = V_O \text{ at temperature } 1.$$
$$V_O(T_2) = V_O \text{ at temperature } 2.$$

Thermal Hysteresis, is defined as the change of output voltage after the device is cycled through temperature from +25°C to -40°C to +85°C and back to +25°C. This is a typical value from a sample of parts put through such a cycle.

$$V_{O_HYS} = V_O(25^\circ\text{C}) - V_{O_TC}$$
$$V_{O_HYS} [ppm] = \frac{V_O(25^\circ\text{C}) - V_{O_TC}}{V_O(25^\circ\text{C})} \times 10^6$$

where:

$$V_O(25^\circ\text{C}) = V_O \text{ at } 25^\circ\text{C}.$$
$$V_{O_TC} = V_O(25^\circ\text{C}) \text{ after temperature cycle at } +25^\circ\text{C to } -40^\circ\text{C to } +85^\circ\text{C and back to } +25^\circ\text{C}.$$

Typical Performance Characteristics—ADR293

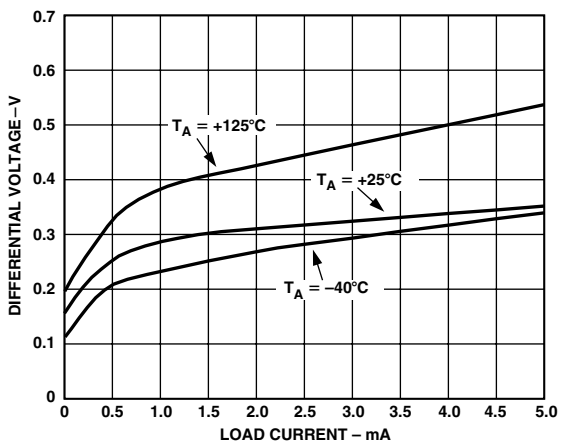
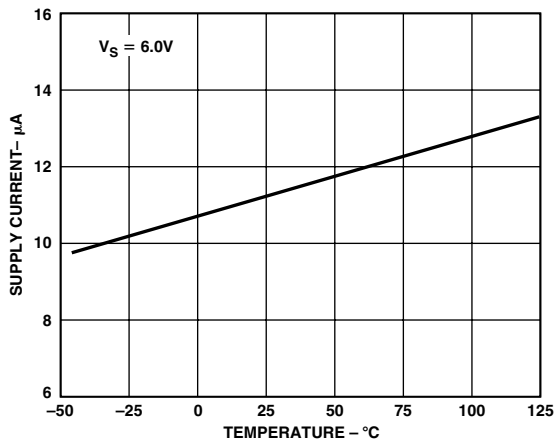
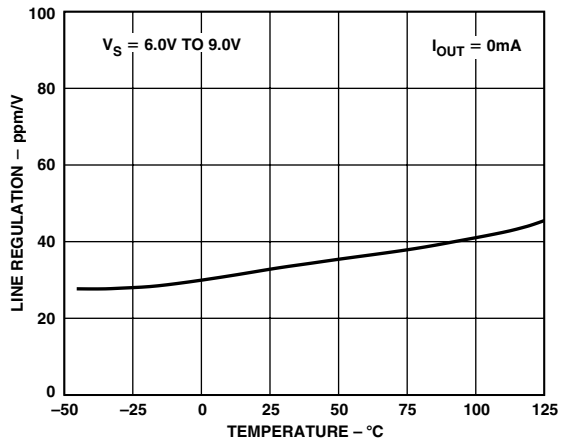
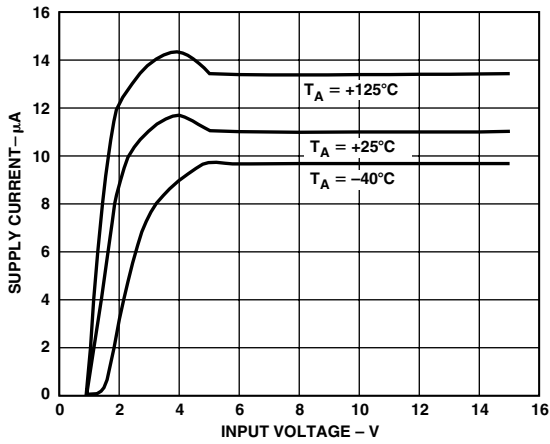
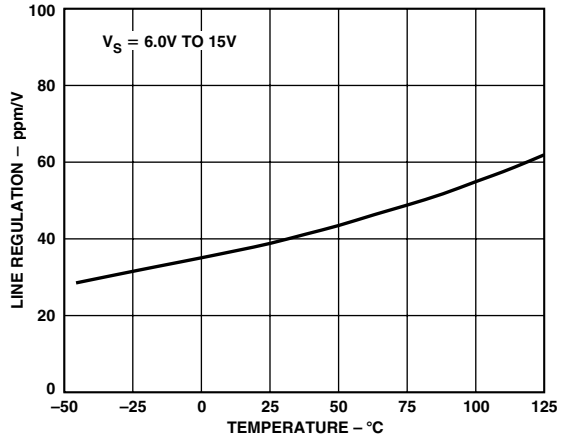
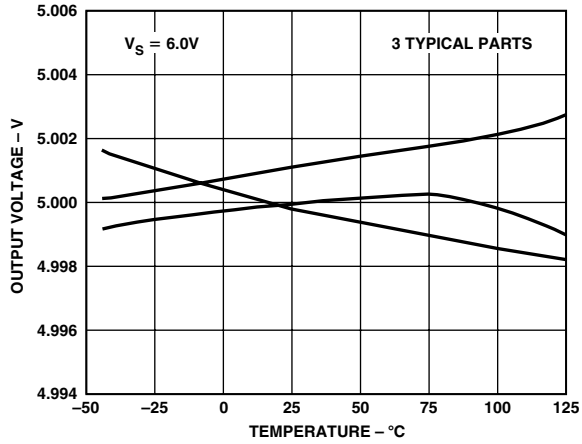

ADR293

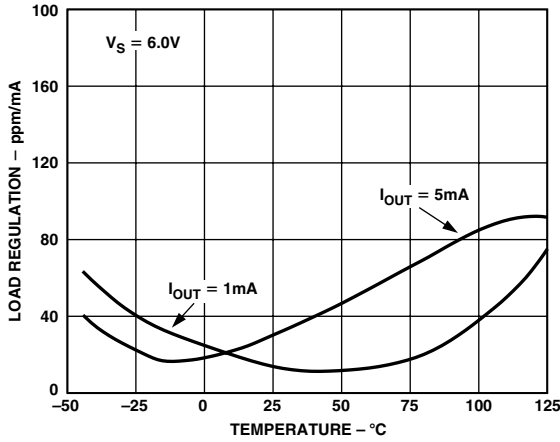

TPC 7. Load Regulation vs. Temperature

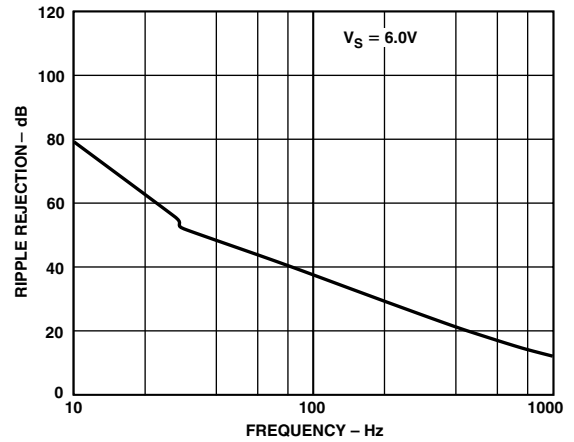

TPC 10. Ripple Rejection vs. Frequency

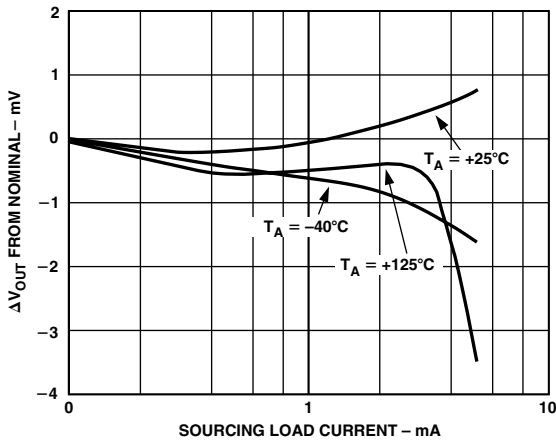

TPC 8. ΔV_{OUT} from Nominal vs. Load Current

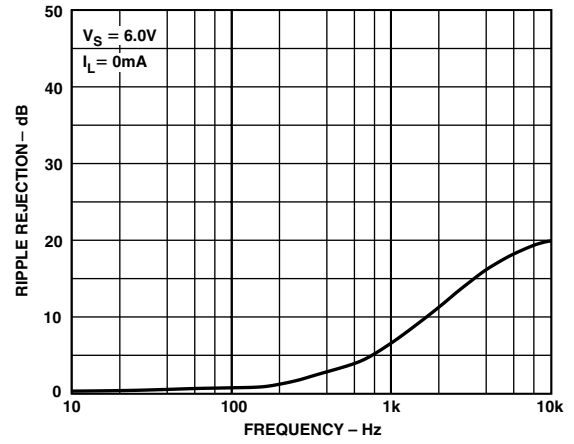

TPC 11. Output Impedance vs. Frequency

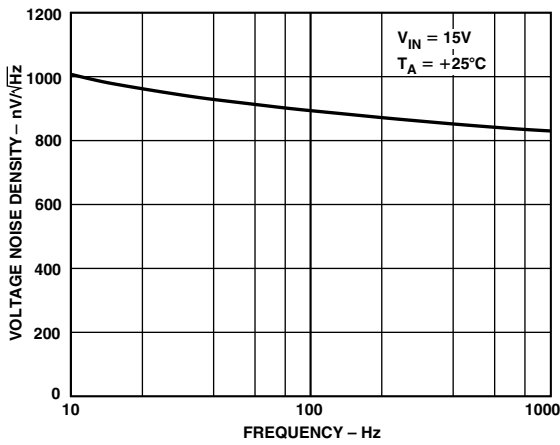

TPC 9. Voltage Noise Density

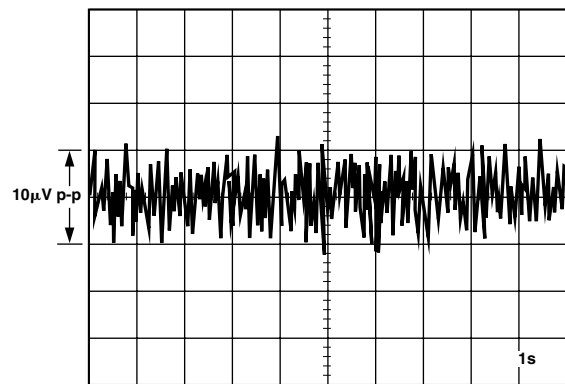

TPC 12. 0.1 Hz to 10 Hz Noise

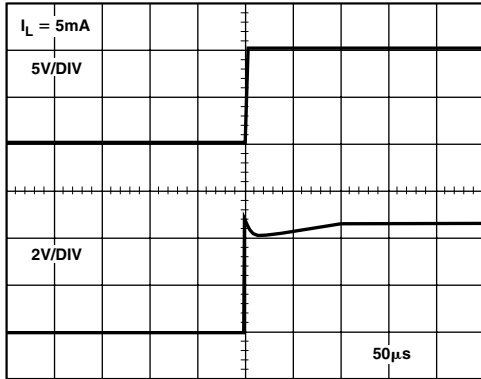

TPC 13. Turn-On Time

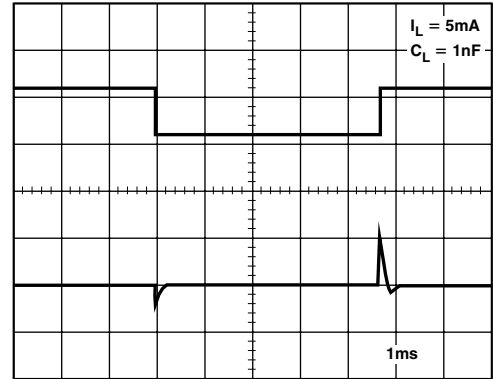

TPC 16. Load Transient

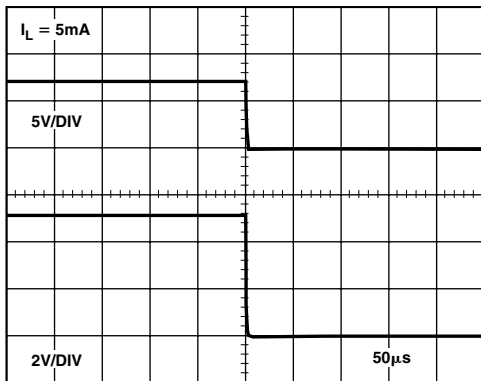

TPC 14. Turn-Off Time

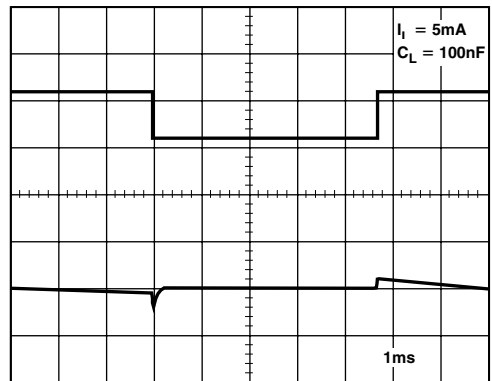

TPC 17. Load Transient

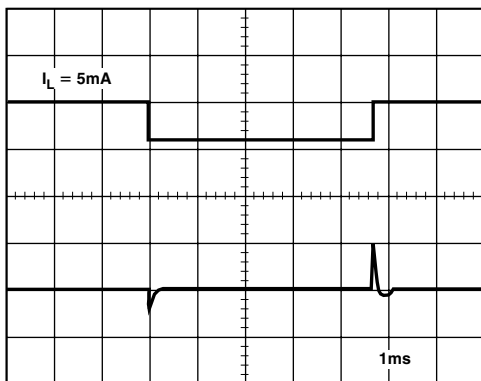

TPC 15. Load Transient

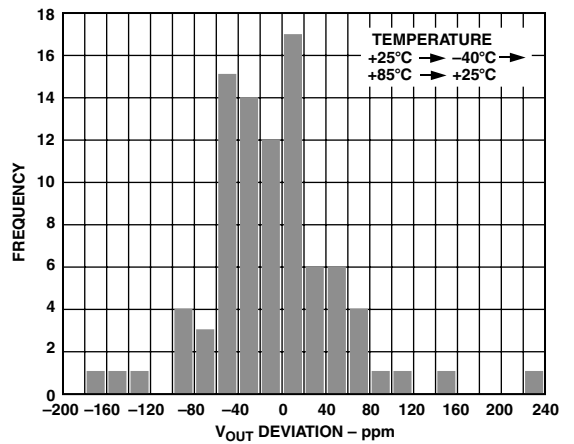

TPC 18. Typical Hysteresis for ADR29x Product

ADR293

THEORY OF OPERATION

The ADR293 uses a new reference generation technique known as XFET, which yields a reference with low noise, low supply current and very low thermal hysteresis.

The core of the XFET reference consists of two junction field-effect transistors one of which has an extra channel implant to raise its pinch-off voltage. By running the two JFETs at the same drain current, the difference in pinch-off voltage can be amplified and used to form a highly stable voltage reference. The intrinsic reference voltage is around 0.5 V with a negative temperature coefficient of about -120 ppm/K. This slope is essentially locked to the dielectric constant of silicon and can be closely compensated by adding a correction term generated in the same fashion as the proportional-to-temperature (PTAT) term used to compensate bandgap references. The big advantage over a bandgap reference is that the intrinsic temperature coefficient is some thirty times lower (therefore less correction is needed) and this results in much lower noise since most of the noise of a bandgap reference comes from the temperature compensation circuitry.

The simplified schematic below shows the basic topology of the ADR293. The temperature correction term is provided by a current source with value designed to be proportional to absolute temperature. The general equation is:

$$V_{OUT} = \Delta V_P \left(\frac{R1 + R2 + R3}{R1} \right) + (I_{PTAT})(R3)$$

where ΔV_P is the difference in pinch-off voltage between the two FETs and I_{PTAT} is the positive temperature coefficient correction current.

The process used for the XFET reference also features vertical NPN and PNP transistors, the latter of which are used as output devices to provide a very low drop-out voltage.

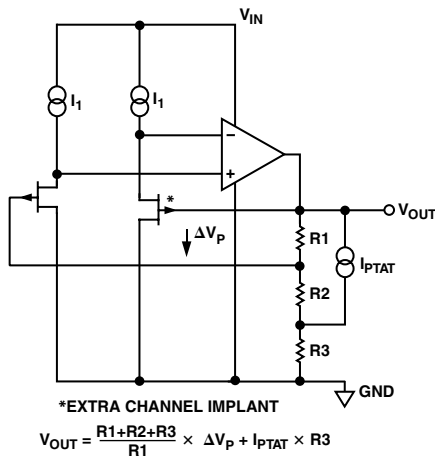

Figure 1. Simplified Schematic

Device Power Dissipation Considerations

The ADR293 is guaranteed to deliver load currents to 5 mA with an input voltage that ranges from 5.5 V to 15 V. When this device is used in applications with large input voltages, care should be exercised to avoid exceeding the published specifications for maximum power dissipation or junction temperature that could result in premature device failure. The following formula should be used to calculate a device's maximum junction temperature or dissipation:

$$P_D = \frac{T_J - T_A}{\theta_{JA}}$$

In this equation, T_J and T_A are the junction and ambient temperatures, respectively, P_D is the device power dissipation, and θ_{JA} is the device package thermal resistance.

Basic Voltage Reference Connections

References, in general, require a bypass capacitor connected from the V_{OUT} pin to the GND pin. The circuit in Figure 2 illustrates the basic configuration for the ADR293. Note that the decoupling capacitors are not required for circuit stability.

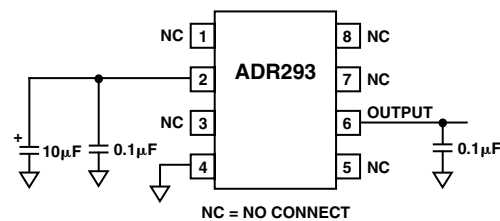

Figure 2. Basic Voltage Reference Configuration

Noise Performance

The noise generated by the ADR293 is typically less than 15 μV p-p over the 0.1 Hz to 10 Hz band. The noise measurement is made with a bandpass filter made of a 2-pole high-pass filter with a corner frequency at 0.1 Hz and a 2-pole low-pass filter with a corner frequency at 10 Hz.

Turn-On Time

Upon application of power (cold start), the time required for the output voltage to reach its final value within a specified error band is defined as the turn-on settling time. Two components normally associated with this are; the time for the active circuits to settle, and the time for the thermal gradients on the chip to stabilize. TPC 13 shows the typical turn-on time for the ADR293.

APPLICATIONS

A Negative Precision Reference without Precision Resistors

In many current-output CMOS DAC applications where the output signal voltage must be of the same polarity as the reference voltage, it is often required to reconfigure a current-switching DAC into a voltage-switching DAC through the use of a 1.25 V reference, an op amp and a pair of resistors. Using a current-switching DAC directly requires the need for an additional operational amplifier at the output to reinvert the signal. A negative voltage reference is then desirable from the point that an additional operational amplifier is not required for either reinversion (current-switching mode) or amplification (voltage-switching mode) of the DAC output voltage. In general, any positive voltage reference can be converted into a negative voltage reference through the use of an operational amplifier and a pair of matched resistors in an inverting configuration. The disadvantage to that approach is that the largest single source of error in the circuit is the relative matching of the resistors used.

The circuit illustrated in Figure 3 avoids the need for tightly matched resistors with the use of an active integrator circuit. In this circuit, the output of the voltage reference provides the input drive for the integrator. The integrator, to maintain circuit equilibrium, adjusts its output to establish the proper relationship between the reference's V_{OUT} and GND. One caveat with this approach should be mentioned: although rail-to-rail output amplifiers work best in the application, these operational amplifiers require a finite amount (mV) of headroom when required to provide any load current. The choice for the circuit's negative supply should take this issue into account.

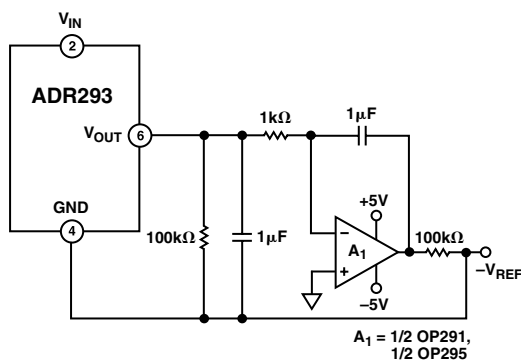

Figure 3. A Negative Precision Voltage Reference Uses No Precision Resistors

A Precision Current Source

Many times in low power applications, the need arises for a precision current source that can operate on low supply voltages. As shown in Figure 4, the ADR293 is configured as a precision current source. The circuit configuration illustrated is a floating current source with a grounded load. The reference's output voltage is bootstrapped across R_{SET} , which sets the output current into the load. With this configuration, circuit precision is maintained for load currents in the range from the reference's supply current, typically 15 μA to approximately 5 mA.

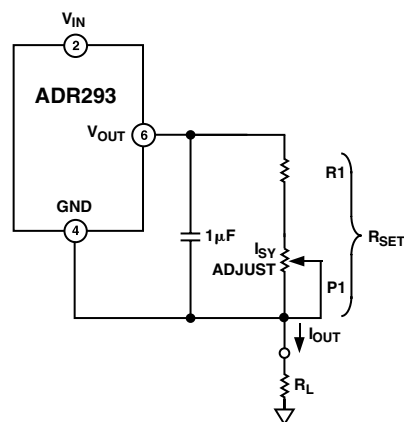

Figure 4. A Precision Current Source

ADR293

Kelvin Connections

In many portable instrumentation applications where PC board cost and area go hand-in-hand, circuit interconnects are very often of dimensionally minimum width. These narrow lines can cause large voltage drops if the voltage reference is required to provide load currents to various functions. In fact, a circuit's interconnects can exhibit a typical line resistance of 0.45 mΩ/square (1 oz. Cu, for example). Force and sense connections also referred to as Kelvin connections, offer a convenient method of eliminating the effects of voltage drops in circuit wires. Load currents flowing through wiring resistance produce an error ($V_{ERROR} = R \times I_L$) at the load. However, the Kelvin connection of Figure 5 overcomes the problem by including the wiring resistance within the forcing loop of the op amp. Since the op amp senses the load voltage, op amp loop control forces the output to compensate for the wiring error and to produce the correct voltage at the load.

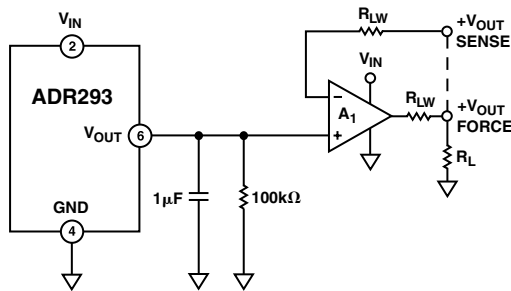

Figure 5. Advantage of Kelvin Connection

Voltage Regulator For Portable Equipment

The ADR293 is ideal for providing a stable, low cost and low power reference voltage in portable equipment power supplies. Figure 6 shows how the ADR293 can be used in a voltage regulator that not only has low output noise (as compared to switch mode design) and low power, but also a very fast recovery after current surges. Some precautions should be taken in the selection of the output capacitors. Too high an ESR (effective series resistance) could endanger the stability of the circuit. A solid tantalum capacitor, 16 V or higher, and an aluminum electrolytic capacitor, 10 V or higher, are recommended for C1 and C2, respectively. Also, the path from the ground side of C1 and C2 to the ground side of R1 should be kept as short as possible.

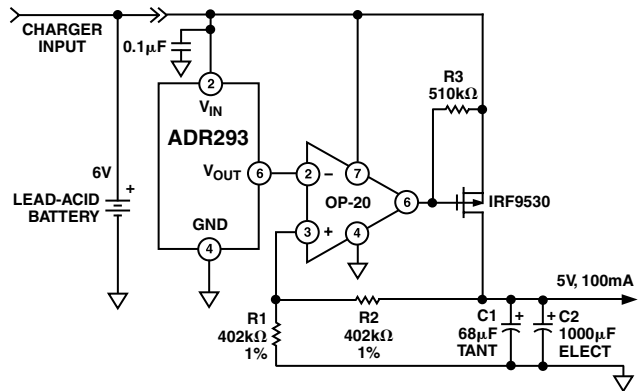
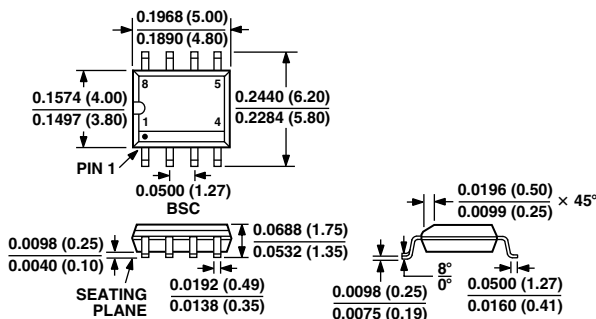

Figure 6. Voltage Regulator for Portable Equipment

OUTLINE DIMENSIONS

Dimensions shown in inches and (mm).

8-Lead Narrow Body SO (SO-8)



8-Lead TSSOP (RU-8)

