

Video signal switcher

BA7602 / BA7602F

The BA7602 and BA7602F are switching ICs developed for use in VCRs. Each contains three two-channel analog multiplexers. They feature a large dynamic range, and wide operating frequency range, and are suitable for switching audio and video signals.

●Applications

Video cassette recorders and televisions

●Features

- 1) Three 2-input / 1-output switches.
- 2) 5V power supply.
- 3) Low power consumption (70mW Typ.).
- 4) Excellent frequency characteristics (10MHz, 0dB Typ.).
- 5) Wide dynamic range (3.1V_{P-P} Typ.).
- 6) High input impedance (20kΩ Typ.).
- 7) Fast switching speed (50ns Typ.).

●Block diagram

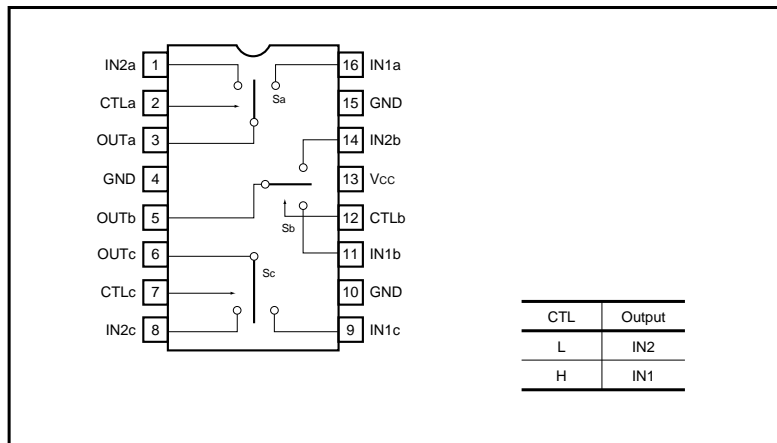

●Absolute maximum ratings (Ta = 25°C)

Parameter	Symbol	Limits	Unit
Power supply voltage	V _{CC}	9	V
Power dissipation	P _d	500*	mW
Operating temperature	T _{opr}	- 40 ~ + 85	°C
Storage temperature	T _{stg}	- 55 ~ + 125	°C

* Reduced by 5.0mW for each increase in Ta of 1°C over 25°C.

●Equivalent circuits

Sa, Sb, Sc

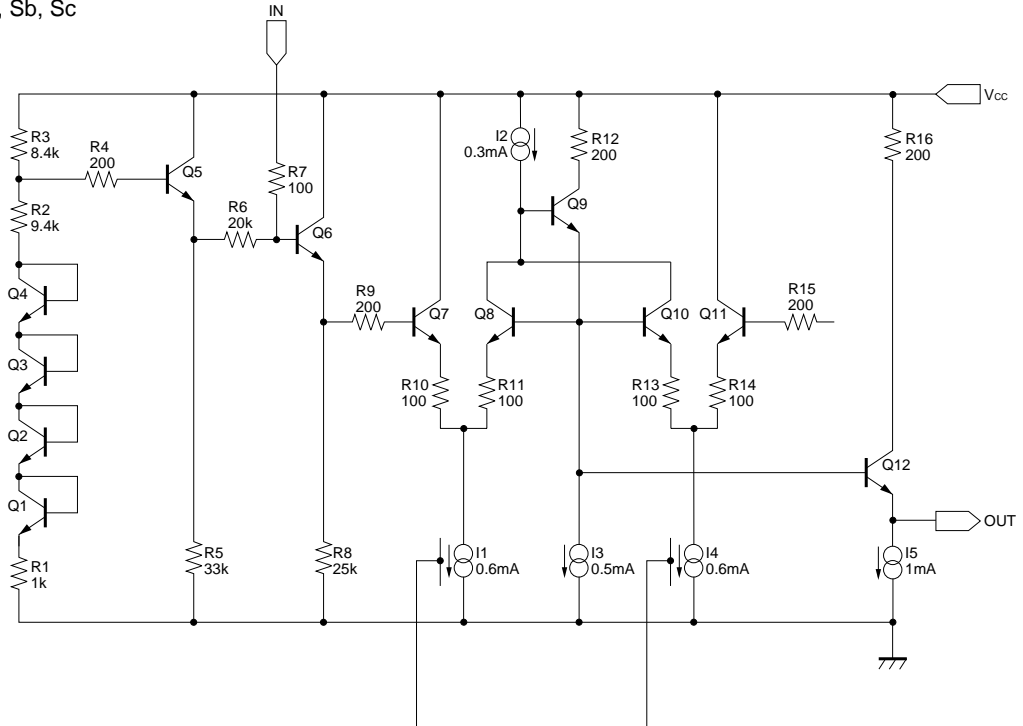

CTL

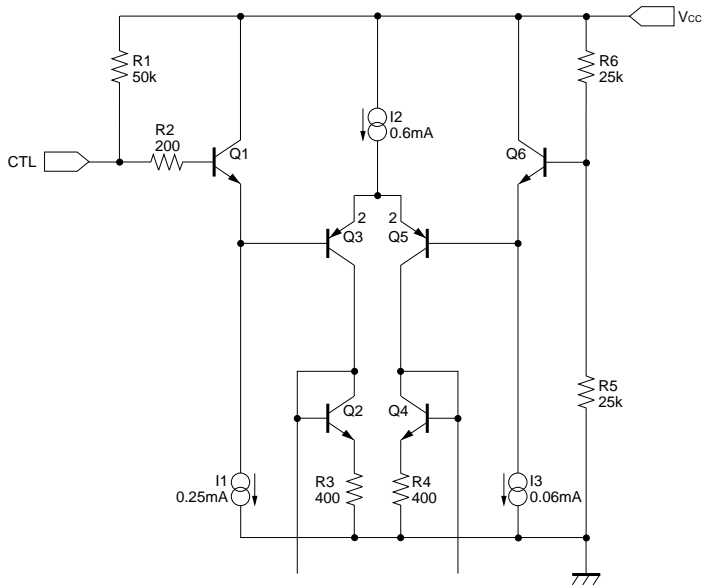

●Electrical characteristics (unless otherwise noted, Ta = 25°C, Vcc = 5.0V)

Parameter	Symbol	Min.	Typ.	Max.	Unit	Conditions
Operating voltage	V _{CC}	4.5	5.0	5.5	V	—
Supply current	I _{CC}	—	14.0	20.5	mA	—
Maximum output level	V _{om}	2.8	3.1	—	V _{P-P}	f = 1kHz, THD = 0.5%
Voltage gain	G _V	-0.5	0	0.5	dB	f = 1MHz, V _{IN} = 1V _{P-P}
Interchannel crosstalk	C _T	—	-65	—	dB	f = 4.43MHz, V _{IN} = 1V _{P-P}
Frequency characteristic	G _f	-3	0	1	dB	10MHz / 1MHz, V _{IN} = 1V _{P-P}
Input impedance	Z _{IN}	14	20	26	kΩ	—
CTL pin switch level	V _{TH}	20	2.5	3.0	V	—

Note: Refer to the measurement circuit given in Fig. 1.

●Reference data

Pin DC voltages (reference values)

Units: Vdc

Pin No.	DC voltage	Pin No.	DC voltage
1	3.27	9	3.27
2	4.91	10	0
3	1.84	11	3.27
4	0	12	4.91
5	1.84	13	5.00
6	1.84	14	3.27
7	4.91	15	0
8	3.27	16	3.27

Electrical characteristics

Parameter	Min.	Typ.	Max.	Unit
Input impedance (no clamp)	—	20k	—	Ω
Output impedance	—	30	—	Ω

The input coupling capacitor values should be 0.1μF to 1μF.

● Measurement circuit

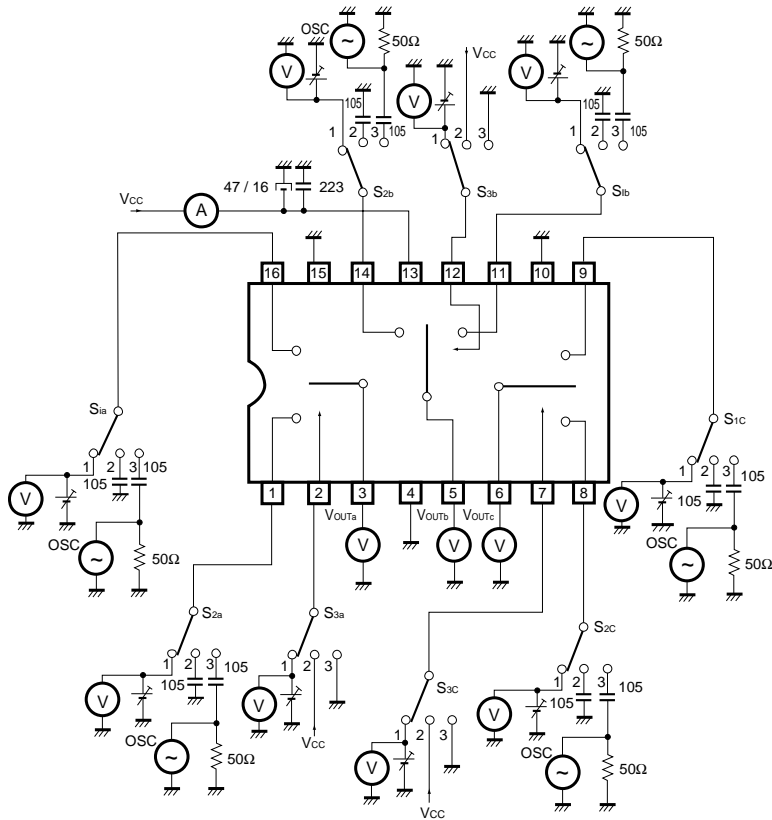

Fig.1

●Measurement conditions

Parameter		Symbol	Switch settings									Measurement method
			S _{1a}	S _{2a}	S _{3a}	S _{1b}	S _{2b}	S _{3b}	S _{1c}	S _{2c}	S _{3c}	
Current dissipation		I _{CC}	2	2	2	2	2	2	2	2	2	
Maximum output level	IN1a	V _{Om}	3	2	2	2	2	2	2	2	2	f = 1kHz THD = 0.5% Note 1
	IN2a	V _{Om}	2	3	3	2	2	2	2	2	2	
	IN1b	V _{Om}	2	2	2	3	2	2	2	2	2	
	IN2b	V _{Om}	2	2	2	2	3	3	2	2	2	
	IN1c	V _{Om}	2	2	2	2	2	2	3	2	2	
	IN2c	V _{Om}	2	2	2	2	2	2	2	3	3	
Voltage gain	IN1a	G _V	3	2	2	2	2	2	2	2	2	f = 1kHz V = 1V _{PP} Note 2
	IN2a	G _V	2	3	3	2	2	2	2	2	2	
	IN1b	G _V	2	2	2	3	2	2	2	2	2	
	IN2b	G _V	2	2	2	2	3	3	2	2	2	
	IN1c	G _V	2	2	2	2	2	2	3	2	2	
	IN2c	G _V	2	2	2	2	2	2	2	3	3	
Interchannel crosstalk	IN1a	C _T	2	3	2	2	2	2	2	2	2	f = 4.43MHz V = 1V _{PP} Note 3
	IN2a	C _T	3	2	3	2	2	2	2	2	2	
	IN1b	C _T	2	2	2	2	3	2	2	2	2	
	IN2b	C _T	2	2	2	3	2	3	2	2	2	
	IN1c	C _T	2	2	2	2	2	2	3	3	2	
	IN2c	C _T	2	2	2	2	2	2	3	2	3	
Frequency characteristic	IN1a	G _f	3	2	2	2	2	2	2	2	2	f = 10M / f = 1M V = 1V _{PP} Note 4
	IN2a	G _f	2	3	3	2	2	2	2	2	2	
	IN1b	G _f	2	2	2	3	2	2	2	2	2	
	IN2b	G _f	2	2	2	2	3	3	2	2	2	
	IN1c	G _f	2	2	2	2	2	2	3	2	2	
	IN2c	G _f	2	2	2	2	2	2	2	3	3	
CTL pin switching level	CTLa	V _{TH}	3	2	1	2	2	2	2	2	2	Note 5
	CTLb	V _{TH}	2	2	2	3	2	1	2	2	2	
	CTLc	V _{TH}	2	2	2	2	2	2	3	2	1	
Input impedance	IN1a	Z _{IN}	1	2	2	2	2	2	2	2	2	Note 6
	IN2a	Z _{IN}	2	1	3	2	2	2	2	2	2	
	IN1b	Z _{IN}	2	2	2	1	2	2	2	2	2	
	IN2b	Z _{IN}	2	2	2	2	1	3	2	2	2	
	IN1c	Z _{IN}	2	2	2	2	2	2	1	2	2	
	IN2c	Z _{IN}	2	2	2	2	2	2	2	1	3	

Note 1: Connect a distortion meter to the output, and input a f = 1kHz sine wave. Adjust the output level until the output distortion is 0.5%.

This output voltage at this time is the maximum output level V_{Om} (V_{P-P}).

Note 2: Input a 1V_{P-P}, 1MHz sine wave. The voltage gain is given by $G_V = 20 \log (V_{OUT} / V_{IN})$.

Note 3: Input a 1V_{P-P}, 4.43MHz sine wave. The interchannel crosstalk is given by $C_T = 20 \log (V_{OUT} / V_{IN})$.

Note 4: Input 1V_{P-P}, 1MHz and 10MHz sine waves. The frequency characteristic is given by $G_f = 20 \log (V_{OUT} (f = 10\text{MHz}) / V_{OUT} (f = 1\text{MHz}))$.

Note 5: Input a 1V_{P-P}, 1MHz sine wave. Reduce the CTL pin voltage from V_{CC}.

The CTL pin switching level (V_{TH}) is the CTL pin voltage at which the V_{out} level drops below 20mV_{P-P}.

Note 6: Measure the input pin voltage V_{IN50} when a current of DC50μA is flowing into the input pin. Measure the input pin open-circuit voltage.

The input impedance is given by $Z = (V_{IN50} - V_{IN0}) / 50 \times 10^{-6} [\Omega]$.

●External dimensions (Units: mm)

