

CD40194B Types

CMOS 4-Bit Bidirectional Universal Shift Register

High-Voltage Types (20 Volt Rating)

■ CD40194B is a universal shift register featuring parallel inputs, parallel outputs SHIFT RIGHT and SHIFT LEFT serial inputs, and a direct overriding clear input. In the parallel-load mode (S0 and S1 are high), data is loaded into the associated flip-flop and appears at the output after the positive transition of the CLOCK input. During loading, serial data flow is inhibited. Shift right and shift left are accomplished synchronously on the positive clock edge with data entered at the SHIFT RIGHT and SHIFT LEFT serial inputs, respectively. Clocking of the register is inhibited when both mode control inputs are low. When low, the RESET input resets all stages and forces all outputs low.

The CD40194B types are supplied in 16-lead dual-in-line plastic packages (E suffix), 16-lead small-outline packages (NSR suffix), and 16-lead thin shrink small-outline packages (PW and PWR suffixes).

MAXIMUM RATINGS, Absolute-Maximum Values:

DC SUPPLY-VOLTAGE RANGE, (V_{DD})	
Voltages referenced to V _{SS} Terminal	-0.5V to +20V
INPUT VOLTAGE RANGE, ALL INPUTS	-0.5V to V _{DD} +0.5V
DC INPUT CURRENT, ANY ONE INPUT	±10mA
POWER DISSIPATION PER PACKAGE (P_D):	
For T _A = -55°C to +100°C	500mW
For T _A = +100°C to +125°C	Derate Linearity at 12mW/°C to 200mW
DEVICE DISSIPATION PER OUTPUT TRANSISTOR	
FOR T _A = FULL PACKAGE-TEMPERATURE RANGE (All Package Types)	100mW
OPERATING-TEMPERATURE RANGE (T_A)	-55°C to +125°C
STORAGE TEMPERATURE RANGE (T_{stg})	-65°C to +150°C
LEAD TEMPERATURE (DURING SOLDERING):	
At distance 1/16 ± 1/32 inch (1.59 ± 0.79mm) from case for 10s max	+265°C

NOT RECOMMENDED FOR NEW DESIGNS

Features:

- Medium-speed: f_{CL} = 12 MHz (typ.) @ V_{DD} = 10 V
- Fully static operation
- Synchronous parallel or serial operation
- Asynchronous master reset
- Standardized, symmetrical output characteristics
- 5-V, 10-V, and 15-V parametric ratings
- Meets all requirements of JEDEC Tentative Standard No. 13B, "Standard Specifications for Description of 'B' Series CMOS Devices"

Applications:

- Arithmetic unit bus registers
- Serial/parallel conversions
- General-purpose register for bus-organized systems
- General-purpose registers

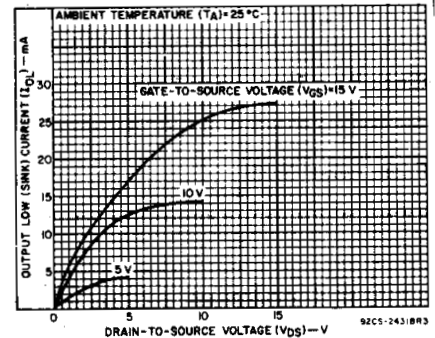
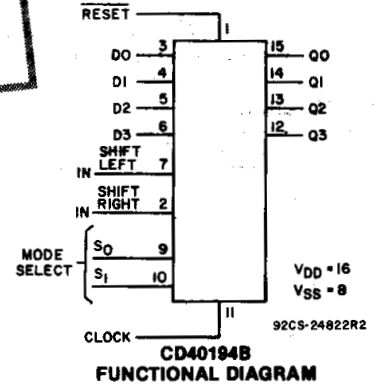

Fig. 1—Typical n-channel output low (sink) current characteristics.

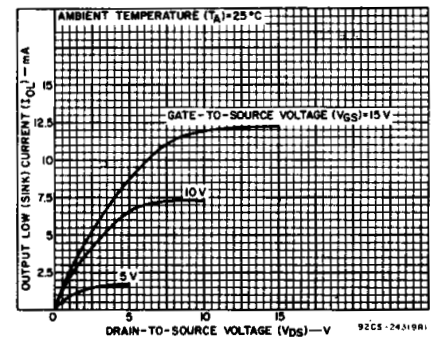

Fig. 2—Minimum n-channel output low (sink) current characteristics.

3
COMMERCIAL CMOS HIGH VOLTAGE ICs

CD40194B Types

RECOMMENDED OPERATING CONDITIONS at $T_A = 25^\circ\text{C}$, Except as Noted.
For maximum reliability, nominal operating conditions should be selected so that operation is always within the following ranges:

CHARACTERISTIC	VDD (V)	LIMITS		UNITS
		Min.	Max.	
Supply-Voltage Range (For Package-Temperature Range)		3	18	V
Setup Time, D0, D3, SR _{IN} , SL _{IN} to clock SELECT 0, SELECT 1 to clock	5	100	—	ns
	10	70	—	
	15	50	—	
Hold Time, D0, D03, SR _{IN} , SL _{IN} to clock SELECT 0, SELECT 1 to clock	5	0	—	ns
	10	0	—	
	15	0	—	
Clock Pulse Width, Clock Input Frequency	5	180	—	MHz
	10	80	—	
	15	50	—	
Clock Input Rise or Fall Time, Reset Pulse Width,	5	1000	—	μs
	10	100	—	
	15	100	—	
Clock Input Frequency	5	—	3	MHz
	10	—	6	
	15	—	8	
Clock Input Rise or Fall Time, Reset Pulse Width,	5	1000	—	μs
	10	100	—	
	15	100	—	
Reset Pulse Width,	5	300	—	ns
	10	200	—	
	15	140	—	

CONTROL TRUTH TABLE FOR CD40194B SERIES

CLOCK	MODE SELECT		RESET	ACTION
	S ₀	S ₁		
X	0	0	1	No Change
	1	0	1	Shift Right (Q0 toward Q3)
	0	1	1	Shift Left (Q3 toward Q0)
	1	1	1	Parallel Load
X	X	X	0	Reset

1 = High level
 0 = Low level

X = Don't care
 ▲ = Level change

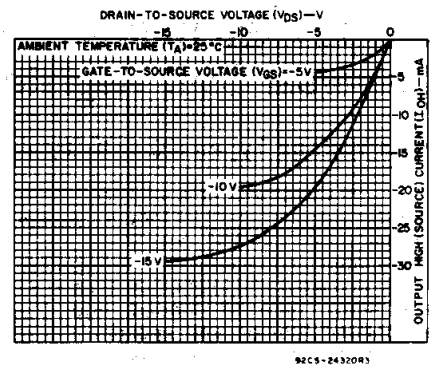

Fig. 3—Typical p-channel output high (source) current characteristics.

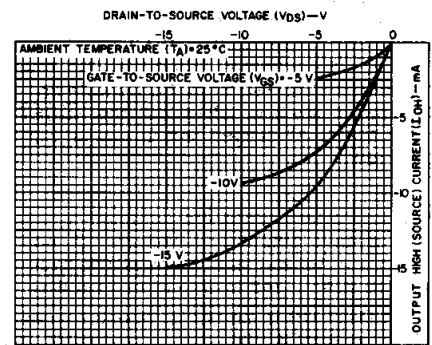

Fig. 4—Minimum p-channel output high (source) current characteristics.

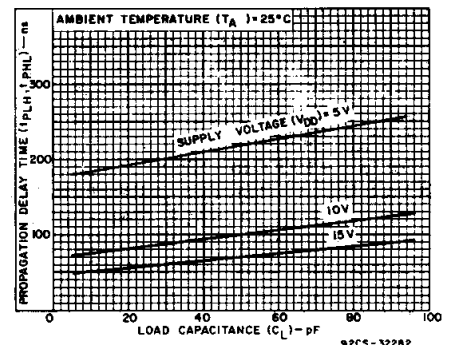

Fig. 5—Typical propagation delay time as a function of load capacitance, (CLOCK to Q).

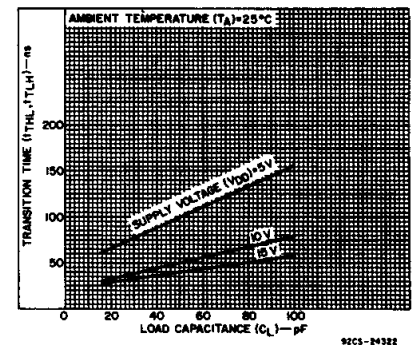

Fig. 6—Typical transition time as a function of load capacitance.

CD40194B Types

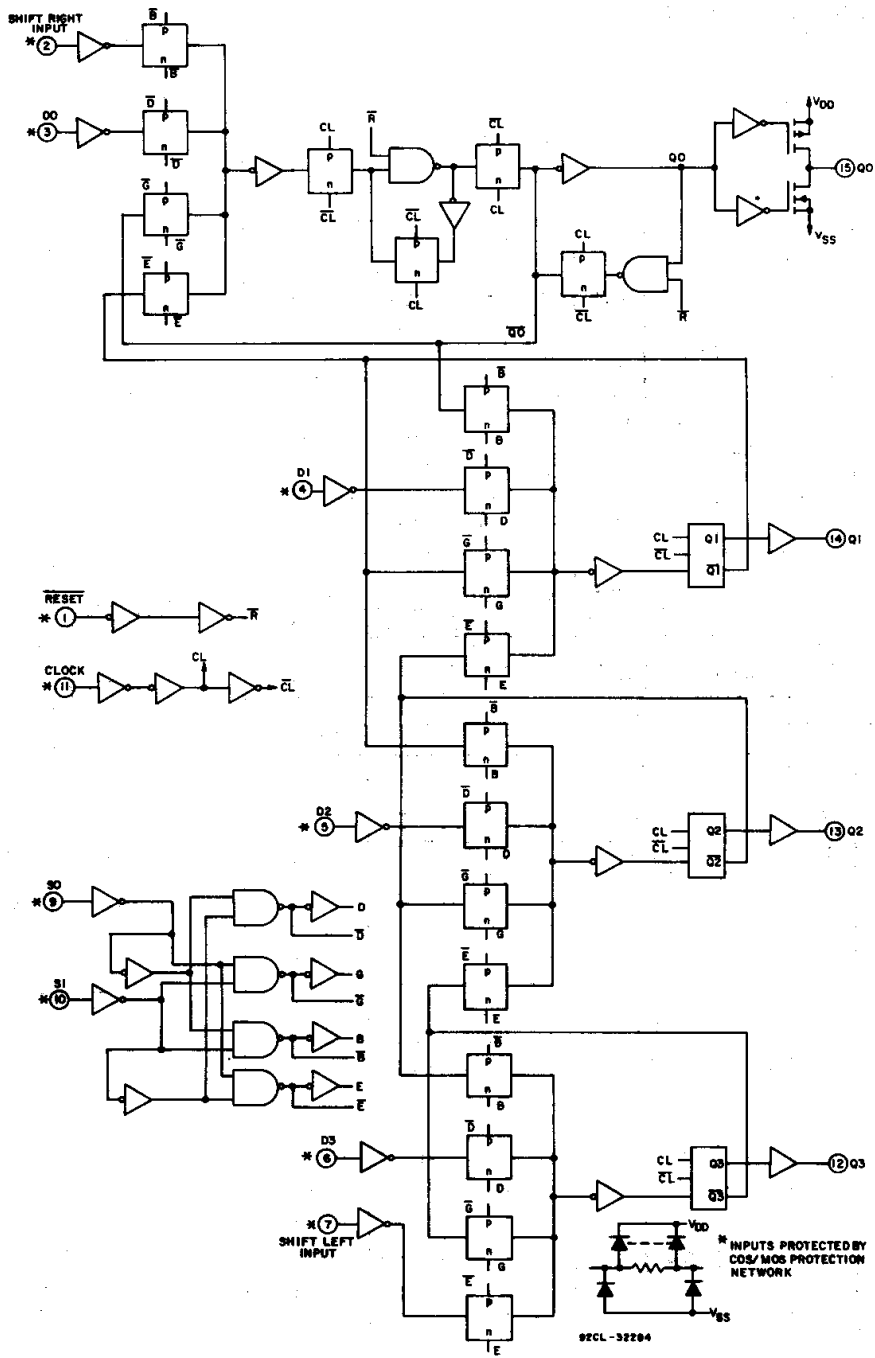

Fig. 8—CD40194B logic diagram.

COMMERCIAL CMOS
HIGH VOLTAGE ICs

CD40194B Types

STATIC ELECTRICAL CHARACTERISTICS

CHARACTERISTIC	CONDITIONS			LIMITS AT INDICATED TEMPERATURES (°C)							UNITS
	V _O (V)	V _{IN} (V)	V _{DD} (V)	-55	-40	+85	+125	+25			
								Min.	Typ.	Max.	
Quiescent Device Current, I _{DD} Max.	—	0,5	5	5	5	150	150	—	0.04	5	μA
	—	0,10	10	10	10	300	300	—	0.04	10	
	—	0,15	15	20	20	600	600	—	0.04	20	
Output Low (Sink) Current, I _{OL} Min.	0.4	0,5	5	0.64	0.61	0.42	0.36	0.51	1	—	mA
	0.5	0,10	10	1.8	1.5	1.1	0.9	1.3	2.6	—	
	1.5	0,15	15	4.2	4	2.8	2.4	3.4	6.8	—	
Output High (Source) Current, I _{OH} Min.	4.6	0,5	5	-0.64	-0.61	-0.42	-0.36	-0.51	-1	—	mA
	2.5	0,5	5	-2	-1.8	-1.3	-1.15	-1.6	-3.2	—	
	9.5	0,10	10	-1.6	-1.5	-1.1	-0.9	-1.3	-2.6	—	
	13.5	0,15	15	-4.2	-4	-2.8	-2.4	-3.4	-6.8	—	
Output Voltage: Low-Level, V _{OL} Max.	—	0,5	5	0.05			—	0	0.05		V
	—	0,10	10	0.05			—	0	0.05		
	—	0,15	15	0.05			—	0	0.05		
Output Voltage: High-Level, V _{OH} Min.	—	0,5	5	4.95			4.95	5	—		V
	—	0,10	10	9.95			9.95	10	—		
	—	0,15	15	14.95			14.95	15	—		
Input Low Voltage, V _{IL} Max.	0.5,4.5	—	5	1.5			—	—	1.5		V
	1,9	—	10	3			—	—	3		
	1.5,13.5	—	15	4			—	—	4		
Input High Voltage, V _{IH} Min.	0.5,4.5	—	5	3.5			3.5	—	—		V
	1,9	—	10	7			7	—	—		
	1.5,13.5	—	15	11			11	—	—		
Input Current I _{IN} Max.	—	0,18	18	±0.1	±0.1	±1	±1	—	±10 ⁻⁵	±0.1	μA
3-State Output Leakage Current, I _{OUT} Max.	0,18	0,18	18	±0.4	±0.4	±12	±12	—	±10 ⁻⁴	±0.4	μA

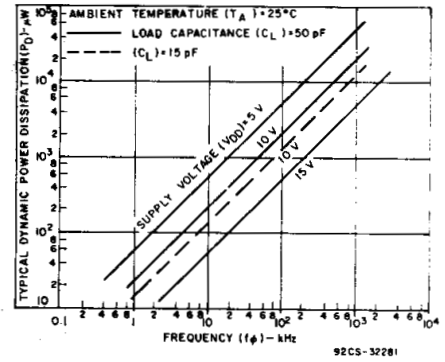

Fig. 9—Typical power dissipation as a function of frequency.

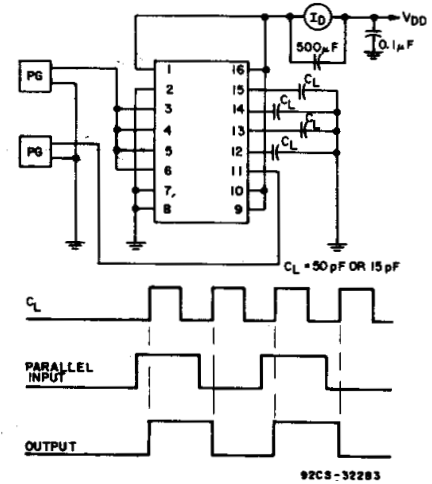

Fig. 10—Dynamic power dissipation test circuit.

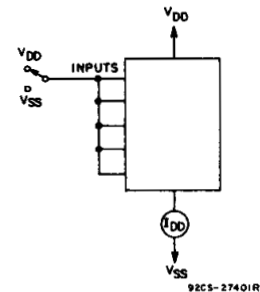

Fig. 11—Quiescent device current test circuit.

CD40194B Types

DYNAMIC ELECTRICAL CHARACTERISTICS at $T_A = 25^\circ\text{C}$,
 Input $t_r, t_f = 20 \text{ ns}$, $C_L = 50 \text{ pF}$, $R_L = 200 \text{ k}\Omega$

CHARACTERISTIC	TEST CONDITIONS	LIMITS			UNITS	
		VDD V	Min.	Typ.		Max.
Propagation Delay Time: Clock to Q t_{PHL}, t_{PLH}		5	—	220	440	ns
		10	—	100	200	
		15	—	70	140	
Output Transition Time t_{THL}, t_{TLH}		5	—	100	200	
		10	—	50	100	
		15	—	40	80	
Minimum Setup Time: t_s D0, D3, SR_{1N}, SL_{1N} to Clock		5	—	80	160	
		10	—	35	70	
		15	—	20	50	
SELECT 0, SELECT 1 to Clock		5	—	200	400	
		10	—	110	220	
		15	—	65	130	
Minimum Hold Time: t_H D0, D3, SR_{1N}, SL_{1N} to Clock		5	—	-65	0	
		10	—	-25	0	
		15	—	-15	0	
SELECT 0, SELECT 1 to Clock		5	—	-170	0	
		10	—	-95	0	
		15	—	-55	0	
Minimum Clock Pulse Width t_W		5	—	90	180	
		10	—	40	80	
		15	—	25	50	
Maximum Clock Input Frequency f_{CL}		5	3	6	—	MHz
		10	6	12	—	
		15	8	15	—	
Maximum Clock Rise or Fall Time t_{rCL}, t_{fCL}		5	—	—	1000	μs
		10	—	—	100	
		15	—	—	100	
Minimum Reset Pulse Width* t_{WR}		5	—	150	300	ns
		10	—	100	200	
		15	—	70	140	
Reset Propagation Delay t_{PRHL}		5	—	230	460	
		10	—	90	180	
		15	—	65	130	
Input Capacitance C_{iN}	Any Input		—	5	7.5	pF

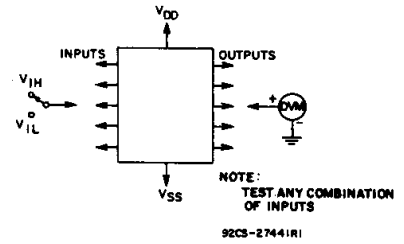

Fig. 12—Input-voltage test circuit.

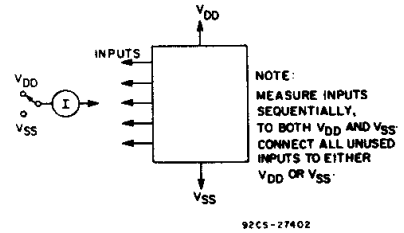
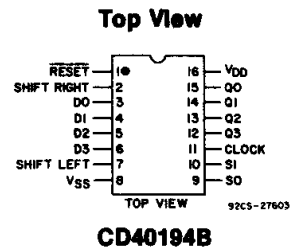

Fig. 13—Input current test circuit.

TERMINAL DIAGRAM



3
COMMERCIAL CMOS
HIGH VOLTAGE ICs

CD40194B Types

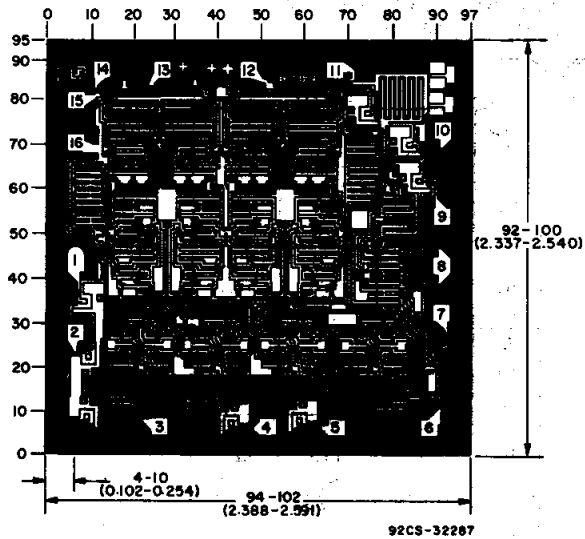

Dimensions and pad layout for CD40194BH

Dimensions in parentheses are in millimeters and are derived from the basic inch dimensions as indicated. Grid graduations are in mils (10^{-3} inch).

PACKAGING INFORMATION

Orderable Device	Status ⁽¹⁾	Package Type	Package Drawing	Pins	Package Qty	Eco Plan ⁽²⁾	Lead/Ball Finish	MSL Peak Temp ⁽³⁾
CD40194BE	ACTIVE	PDIP	N	16	25	Pb-Free (RoHS)	CU NIPDAU	N / A for Pkg Type
CD40194BEE4	ACTIVE	PDIP	N	16	25	Pb-Free (RoHS)	CU NIPDAU	N / A for Pkg Type

⁽¹⁾ The marketing status values are defined as follows:

ACTIVE: Product device recommended for new designs.

LIFEBUY: TI has announced that the device will be discontinued, and a lifetime-buy period is in effect.

NRND: Not recommended for new designs. Device is in production to support existing customers, but TI does not recommend using this part in a new design.

PREVIEW: Device has been announced but is not in production. Samples may or may not be available.

OBsolete: TI has discontinued the production of the device.

⁽²⁾ Eco Plan - The planned eco-friendly classification: Pb-Free (RoHS), Pb-Free (RoHS Exempt), or Green (RoHS & no Sb/Br) - please check <http://www.ti.com/productcontent> for the latest availability information and additional product content details.

TBD: The Pb-Free/Green conversion plan has not been defined.

Pb-Free (RoHS): TI's terms "Lead-Free" or "Pb-Free" mean semiconductor products that are compatible with the current RoHS requirements for all 6 substances, including the requirement that lead not exceed 0.1% by weight in homogeneous materials. Where designed to be soldered at high temperatures, TI Pb-Free products are suitable for use in specified lead-free processes.

Pb-Free (RoHS Exempt): This component has a RoHS exemption for either 1) lead-based flip-chip solder bumps used between the die and package, or 2) lead-based die adhesive used between the die and leadframe. The component is otherwise considered Pb-Free (RoHS compatible) as defined above.

Green (RoHS & no Sb/Br): TI defines "Green" to mean Pb-Free (RoHS compatible), and free of Bromine (Br) and Antimony (Sb) based flame retardants (Br or Sb do not exceed 0.1% by weight in homogeneous material)

⁽³⁾ MSL, Peak Temp. -- The Moisture Sensitivity Level rating according to the JEDEC industry standard classifications, and peak solder temperature.

Important Information and Disclaimer:The information provided on this page represents TI's knowledge and belief as of the date that it is provided. TI bases its knowledge and belief on information provided by third parties, and makes no representation or warranty as to the accuracy of such information. Efforts are underway to better integrate information from third parties. TI has taken and continues to take reasonable steps to provide representative and accurate information but may not have conducted destructive testing or chemical analysis on incoming materials and chemicals. TI and TI suppliers consider certain information to be proprietary, and thus CAS numbers and other limited information may not be available for release.

In no event shall TI's liability arising out of such information exceed the total purchase price of the TI part(s) at issue in this document sold by TI to Customer on an annual basis.

N (R-PDIP-T**)

PLASTIC DUAL-IN-LINE PACKAGE

16 PINS SHOWN



- NOTES:
- A. All linear dimensions are in inches (millimeters).
 - B. This drawing is subject to change without notice.
 - C Falls within JEDEC MS-001, except 18 and 20 pin minimum body length (Dim A).
 - D The 20 pin end lead shoulder width is a vendor option, either half or full width.

4040049/E 12/2002

IMPORTANT NOTICE

Texas Instruments Incorporated and its subsidiaries (TI) reserve the right to make corrections, modifications, enhancements, improvements, and other changes to its products and services at any time and to discontinue any product or service without notice. Customers should obtain the latest relevant information before placing orders and should verify that such information is current and complete. All products are sold subject to TI's terms and conditions of sale supplied at the time of order acknowledgment.

TI warrants performance of its hardware products to the specifications applicable at the time of sale in accordance with TI's standard warranty. Testing and other quality control techniques are used to the extent TI deems necessary to support this warranty. Except where mandated by government requirements, testing of all parameters of each product is not necessarily performed.

TI assumes no liability for applications assistance or customer product design. Customers are responsible for their products and applications using TI components. To minimize the risks associated with customer products and applications, customers should provide adequate design and operating safeguards.

TI does not warrant or represent that any license, either express or implied, is granted under any TI patent right, copyright, mask work right, or other TI intellectual property right relating to any combination, machine, or process in which TI products or services are used. Information published by TI regarding third-party products or services does not constitute a license from TI to use such products or services or a warranty or endorsement thereof. Use of such information may require a license from a third party under the patents or other intellectual property of the third party, or a license from TI under the patents or other intellectual property of TI.

Reproduction of TI information in TI data books or data sheets is permissible only if reproduction is without alteration and is accompanied by all associated warranties, conditions, limitations, and notices. Reproduction of this information with alteration is an unfair and deceptive business practice. TI is not responsible or liable for such altered documentation. Information of third parties may be subject to additional restrictions.

Resale of TI products or services with statements different from or beyond the parameters stated by TI for that product or service voids all express and any implied warranties for the associated TI product or service and is an unfair and deceptive business practice. TI is not responsible or liable for any such statements.

TI products are not authorized for use in safety-critical applications (such as life support) where a failure of the TI product would reasonably be expected to cause severe personal injury or death, unless officers of the parties have executed an agreement specifically governing such use. Buyers represent that they have all necessary expertise in the safety and regulatory ramifications of their applications, and acknowledge and agree that they are solely responsible for all legal, regulatory and safety-related requirements concerning their products and any use of TI products in such safety-critical applications, notwithstanding any applications-related information or support that may be provided by TI. Further, Buyers must fully indemnify TI and its representatives against any damages arising out of the use of TI products in such safety-critical applications.

TI products are neither designed nor intended for use in military/aerospace applications or environments unless the TI products are specifically designated by TI as military-grade or "enhanced plastic." Only products designated by TI as military-grade meet military specifications. Buyers acknowledge and agree that any such use of TI products which TI has not designated as military-grade is solely at the Buyer's risk, and that they are solely responsible for compliance with all legal and regulatory requirements in connection with such use.

TI products are neither designed nor intended for use in automotive applications or environments unless the specific TI products are designated by TI as compliant with ISO/TS 16949 requirements. Buyers acknowledge and agree that, if they use any non-designated products in automotive applications, TI will not be responsible for any failure to meet such requirements.

Following are URLs where you can obtain information on other Texas Instruments products and application solutions:

Products		Applications	
Amplifiers	amplifier.ti.com	Audio	www.ti.com/audio
Data Converters	dataconverter.ti.com	Automotive	www.ti.com/automotive
DLP® Products	www.dlp.com	Communications and Telecom	www.ti.com/communications
DSP	dsp.ti.com	Computers and Peripherals	www.ti.com/computers
Clocks and Timers	www.ti.com/clocks	Consumer Electronics	www.ti.com/consumer-apps
Interface	interface.ti.com	Energy	www.ti.com/energy
Logic	logic.ti.com	Industrial	www.ti.com/industrial
Power Mgmt	power.ti.com	Medical	www.ti.com/medical
Microcontrollers	microcontroller.ti.com	Security	www.ti.com/security
RFID	www.ti-rfid.com	Space, Avionics & Defense	www.ti.com/space-avionics-defense
RF/IF and ZigBee® Solutions	www.ti.com/lprf	Video and Imaging	www.ti.com/video
		Wireless	www.ti.com/wireless-apps

Mailing Address: Texas Instruments, Post Office Box 655303, Dallas, Texas 75265
Copyright © 2010, Texas Instruments Incorporated