

Comlinear CLC440

High-Speed, Low-Power, Voltage Feedback Op Amp

General Description

The Comlinear CLC440 is a wideband, low-power, voltage feedback op amp that offers 750MHz unity-gain bandwidth, 1500V/ μ s slew rate, and 90mA output current. For video applications, the CLC440 sets new standards for voltage feedback monolithics by offering the impressive combination of 0.015% differential gain and 0.025° differential phase errors while dissipating a mere 70mW.

The CLC440 incorporates the proven properties of Comlinear's current feedback amplifiers (high bandwidth, fast slewing, etc.) into a "classical" voltage feedback architecture. This amplifier possesses truly differential and fully symmetrical inputs both having a high 900k Ω impedance with matched low input bias currents. Furthermore, since the CLC440 incorporates voltage feedback, a specific R_f is not required for stability. This flexibility in choosing R_f allows for numerous applications in wideband filtering and integration.

Unlike several other high-speed voltage feedback op amps, the CLC440 operates with a wide range of dual or single supplies allowing for use in a multitude of applications with limited supply availability. The CLC440's low 3.5nV/ $\sqrt{\text{Hz}}$ (e_n) and 2.5pA/ $\sqrt{\text{Hz}}$ (i_n) noise sets a very low noise floor.

Features

- Unity-gain stable
- High unity-gain bandwidth: 750MHz
- Ultra-low differential gain: 0.015%
- Very low differential phase: 0.025°
- Low power: 70mW
- Extremely fast slew rate: 1500V/ μ s
- High output current: 90mA
- Low noise: 3.5nV/ $\sqrt{\text{Hz}}$
- Dual $\pm 2.5\text{V}$ to $\pm 6\text{V}$ or single 5V to 12V supplies

Applications

- Professional video
- Graphics workstations
- Test equipment
- Video switching & routing
- Communications
- Medical imaging
- A/D drivers
- Photo diode transimpedance amplifiers
- Improved replacement for CLC420 or OPA620

Frequency Response ($A_v = +2\text{V/V}$)

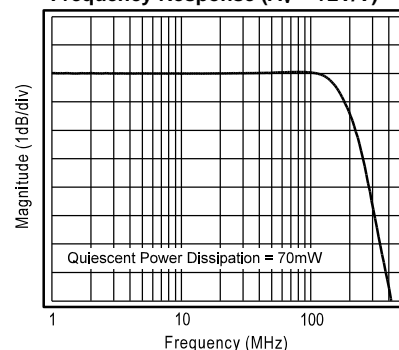

Typical Application

10MHz to 40MHz Square and Triangular Wave Generator

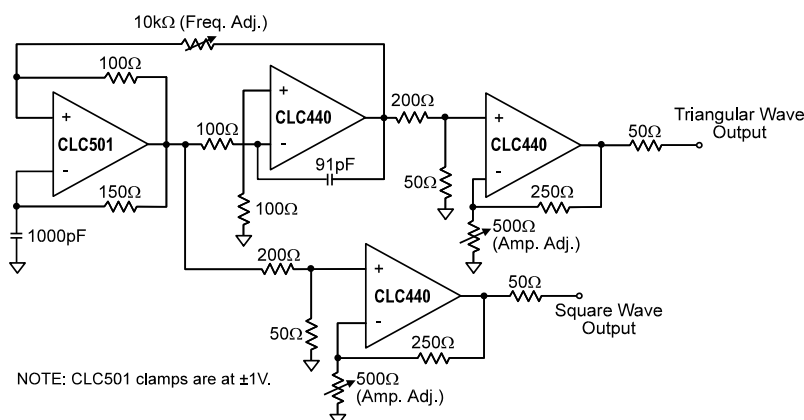

Generator Waveforms

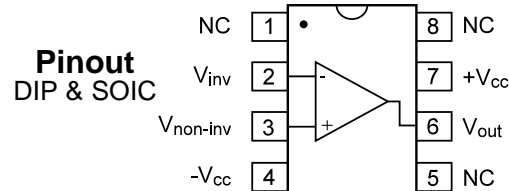
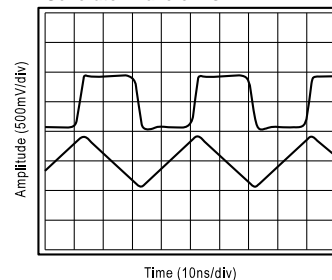

CLC440 Electrical Characteristics ($A_V = +2$, $R_f = R_g = 250\Omega$; $V_{cc} = \pm 5V$, $R_L = 100\Omega$ unless specified)

PARAMETERS	CONDITIONS	TYP	MIN/MAX RATINGS			UNITS	NOTES
Ambient Temperature	CLC440	+25°C	+25°C	0 to 70°C	-40 to 85°C		
FREQUENCY DOMAIN RESPONSE							
-3dB bandwidth $A_V = +2$	$V_{out} < 0.2V_{pp}$	260	165	165	135	MHz	B
	$V_{out} < 4.0V_{pp}$	190	150	135	130	MHz	
-3dB bandwidth $A_V = +1$	$V_{out} < 0.2V_{pp}$	750				MHz	
gain bandwidth product	$V_{out} < 0.2V_{pp}$	230				MHz	
gain flatness	$V_{out} < 2.0V_{pp}$ DC to 75MHz	0.05	0.15	0.20	0.20	dB	
linear phase deviation	$V_{out} < 2.0V_{pp}$ DC to 75MHz	0.8	1.2	1.5	1.5	deg	
differential gain	4.43MHz, $R_L = 150\Omega$	0.015	0.03	0.04	0.04	%	
differential phase	4.43MHz, $R_L = 150\Omega$	0.025	0.05	0.06	0.06	deg	
TIME DOMAIN RESPONSE							
rise and fall time	2V step	1.5	2.0	2.2	2.5	ns	
	4V step	3.2	4.2	4.5	5.0	ns	
settling time to 0.05%	2V step	10	14	16	16	ns	
overshoot	4V step	7	13	13	13	%	
slew rate	4V step, $\pm 0.5V$ crossing	1500	900	750	600	V/ μ s	
DISTORTION AND NOISE RESPONSE							
2nd harmonic distortion	$2V_{pp}$, 5MHz	-64	-59	-59	-59	dBc	B
	$2V_{pp}$, 20MHz	-52	-46	-46	-46	dBc	
3rd harmonic distortion	$2V_{pp}$, 5MHz	-70	-65	-64	-64	dBc	B
	$2V_{pp}$, 20MHz	-51	-45	-43	-43	dBc	
equivalent input noise voltage	>1MHz	3.5	4.5	5.0	5.0	nV/ \sqrt Hz	
current	>1MHz	2.5	3.5	4.0	4.0	pA/ \sqrt Hz	
STATIC DC PERFORMANCE							
input offset voltage		1.0	3.0	3.5	4.0	mV	A
average drift		5.0		10	10	μ V/ $^{\circ}$ C	
input bias current		10	30	35	40	μ A	A
average drift		30		50	60	nA/ $^{\circ}$ C	
input offset current		0.5	2.0	2.0	3.0	μ A	A
average drift		3.0		10	10	nA/ $^{\circ}$ C	
power supply rejection ratio	DC	65	58	58	58	dB	A
common-mode rejection ratio	DC	80	65	60	60	dB	A
supply current	$R_L = \infty$	7.0	7.5	8.0	8.0	mA	A
MISCELLANEOUS PERFORMANCE							
input resistance	common-mode	900	500	400	300	k Ω	
input capacitance	common-mode	1.2	2.0	2.0	2.0	pF	
	differential-mode	0.5	1.0	1.0	1.0	pF	
input voltage range	common-mode	± 3.0	± 2.8	± 2.7	± 2.7	V	
output voltage range	$R_L = 100\Omega$	± 2.5	± 2.3	± 2.2	± 2.2	V	
output voltage range	$R_L = \infty$	± 3.0	± 2.8	± 2.7	± 2.7	V	
output current		± 90	± 80	± 65	± 45	mA	

Min/max ratings are based on product characterization and simulation. Individual parameters are tested as noted. Outgoing quality levels are determined from tested parameters.

Absolute Maximum Ratings

voltage supply	$\pm 6V$
I_{out} is short circuit protected to ground	
common-mode input voltage	$\pm V_{cc}$
maximum junction temperature	+175°C
storage temperature range	-65°C to +150°C
lead temperature (soldering 10 sec)	+300°C

Package Thermal Resistance

Package	θ_{jc}	θ_{ja}
Plastic (AJP)	90°/W	105°/W
Surface Mount (AJE)	110°/W	130°/W
CerDip	40°/W	130°/W

Ordering Information

Model	Temperature Range	Description
CLC440AJP	-40°C to +85°C	8-pin PDIP
CLC440AJE	-40°C to +85°C	8-pin SOIC
CLC440ALC	-40°C to +85°C	dice
CLC440A8B	-55°C to +125°C	8-pin hermetic CerDIP, MIL-STD-883
CLC440AMC	-55°C to +125°C	dice, MIL-STD-883

Contact factory for SMD number.

Notes

- A) J-level: spec is 100% tested at +25°C, sample tested at +85°C.
 LC/MC-level: spec is 100% wafer probed at +25°C.
 B) J-level: spec is sample tested at +25°C.

CLC440 Typical Performance Characteristics ($A_V = +2$, $R_f = 250\Omega$; $V_{CC} = \pm 5V$, $R_L = 100\Omega$ unless specified)

Non-Inverting Frequency Response

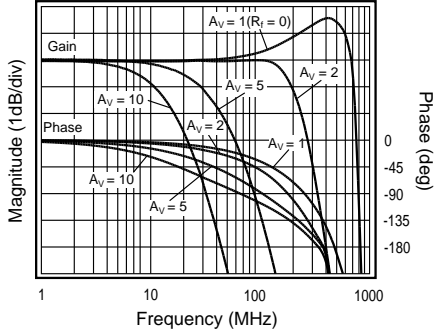

Inverting Frequency Response

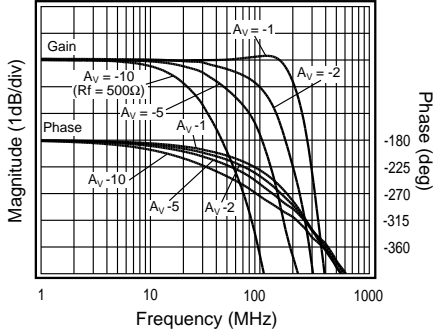

Frequency Response vs. Load

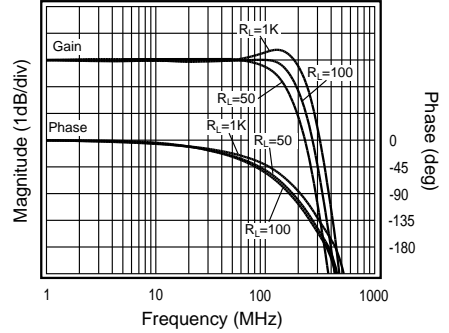

Frequency Response vs. V_{out}

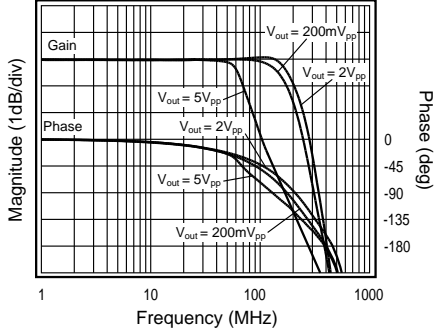

Frequency Response vs. Capacitive Load

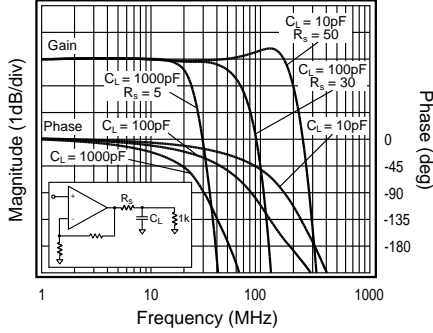

Gain Flatness and Linear Phase

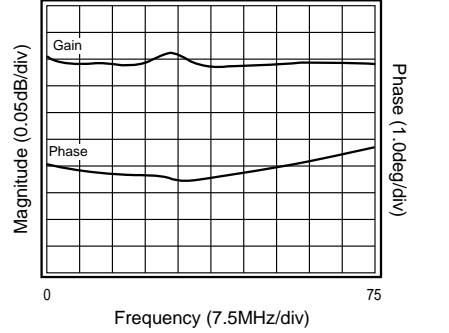

Open Loop Gain and Phase

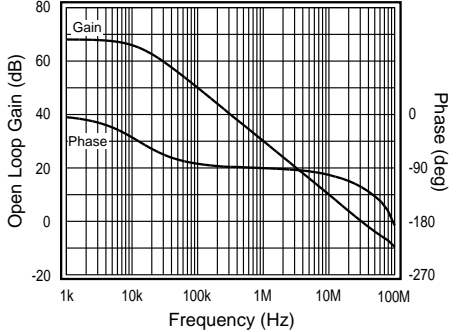

BW vs. Gain for Transimpedance Configuration

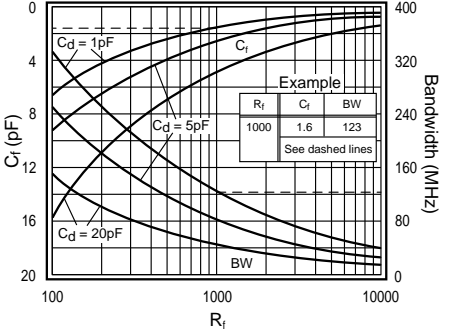

Equivalent Input Noise

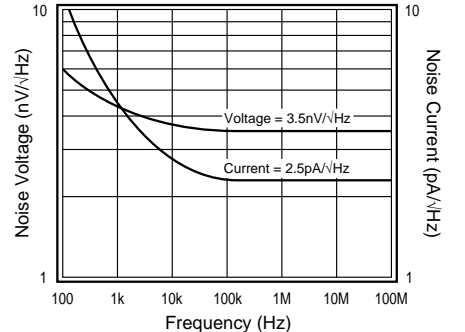

Harmonic Distortion vs. Frequency

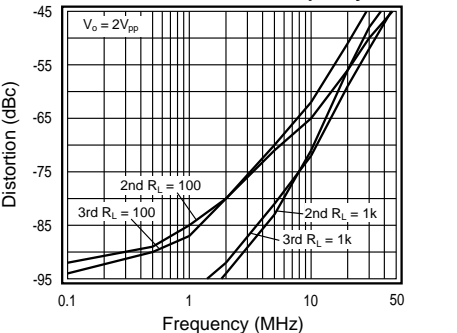

1dB Compression

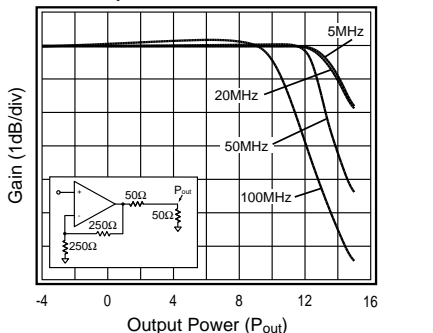

PSRR, CMRR, and Closed Loop R_{out}

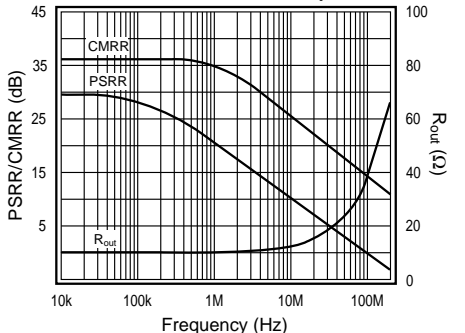

Input and Output VSWR

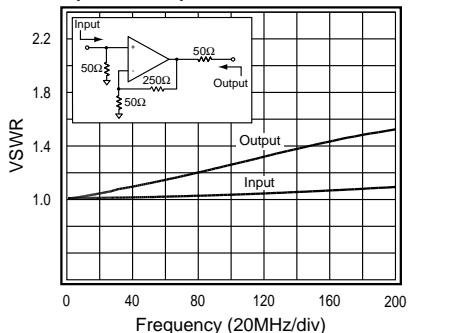

2-Tone, 3rd Order Intermodulation Intercept

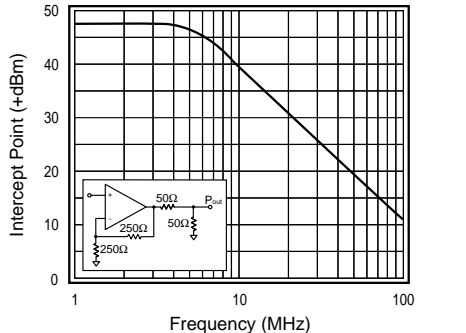

Differential Gain and Phase

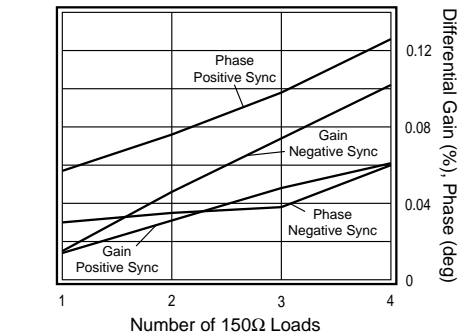

CLC440 Typical Performance Characteristics ($A_V = +2$, $R_f = 250\Omega$; $V_{CC} = \pm 5V$, $R_L = 100\Omega$ unless specified)

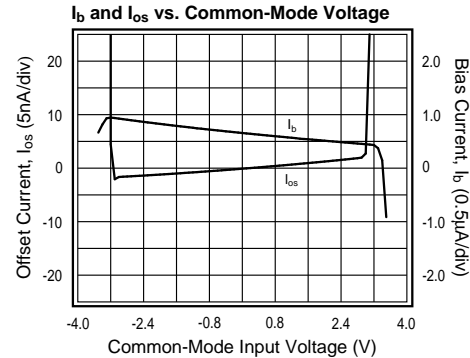
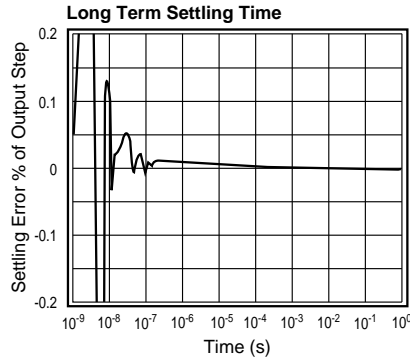
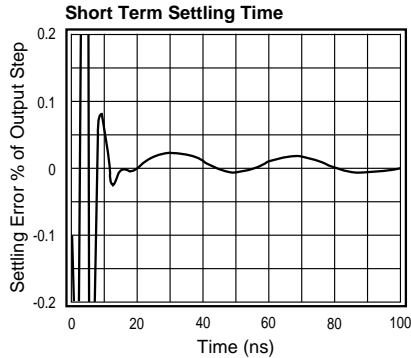
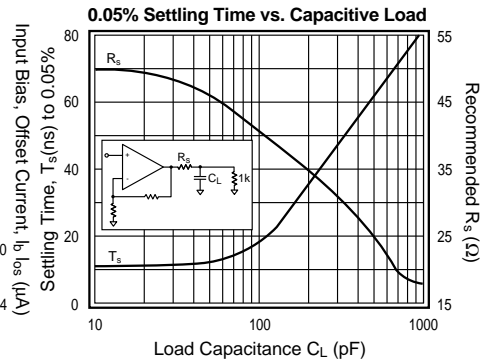
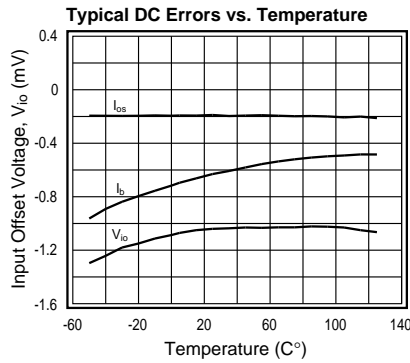
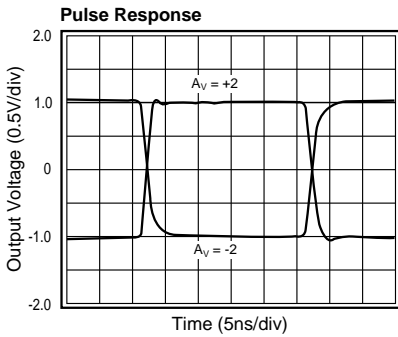

APPLICATION INFORMATION

General Design Equations

The CLC440 is a unity gain stable voltage feedback amplifier. The matched input bias currents track well over temperature. This allows the DC offset to be minimized by matching the impedance seen by both inputs.

Gain

The non-inverting and inverting gain equations for the CLC440 are as follows:

$$\text{Non-inverting Gain: } 1 + \frac{R_f}{R_g}$$

$$\text{Inverting Gain: } -\frac{R_f}{R_g}$$

Gain Bandwidth Product

The CLC440 is a voltage feedback amplifier, whose closed-loop bandwidth is approximately equal to the gain-bandwidth product (GBP) divided by the gain (A_V). For gains greater than 5, A_V sets the closed-loop bandwidth of the CLC440.

$$\text{Closed Loop Bandwidth} = \frac{\text{GBP}}{A_V}$$

$$A_V = \frac{(R_f + R_g)}{R_g}$$

$$\text{GBP} = 230\text{MHz}$$

For gains less than 5, refer to the frequency response plots to determine maximum bandwidth.

Output Drive and Settling Time Performance

The CLC440 has large output current capability. The 90mA of output current makes the CLC440 an excellent choice for applications such as:

- Video Line Drivers
- Distribution Amplifiers

When driving a capacitive load or coaxial cable, include a series resistance R_S to back match or improve settling time. Refer to the "Settling Time vs. Capacitive Load" plot in the typical performance section to determine the recommended resistance for various capacitive loads.

When driving resistive loads of under 500Ω, settling time performance diminishes. This degradation occurs because a small change in voltage on the output causes a large change of current in the power supplies. This current creates ringing on the power supplies. A small resistor will dampen this effect if placed in series with the 6.8μF bypass capacitor.

Noise Figure

Noise Figure (NF) is a measure of noise degradation caused by an amplifier.

$$\text{NF} = 10\text{LOG} \left(\frac{S_i/N_i}{S_o/N_o} \right) = 10\text{LOG} \left(\frac{e_{ni}^2}{e_t^2} \right)$$

where,

e_{ni} = Total Equivalent Input Noise Density Due to the Amplifier

e_t = Thermal Voltage Noise ($\sqrt{4kTR_{seq}}$)

Figure 1 shows the noise model for the non-inverting amplifier configuration. The model includes all of the following noise sources:

- Input voltage noise (e_n)
- Input current noise ($i_n = i_{n+} = i_{n-}$)
- Thermal Voltage Noise (e_f) associated with each external resistor

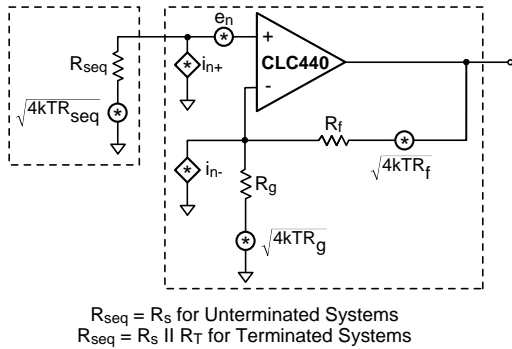

Figure 1: Non-inverting Amplifier Noise Model

The total equivalent input noise density is calculated by using the noise model shown. Equations 1 and 2 represent the noise equation and the resulting equation for noise figure.

$$e_{ni} = \sqrt{e_n^2 + i_n^2 \left(R_{seq}^2 + (R_f || R_g)^2 \right) + 4kTR_{seq} + 4kT(R_f || R_g)}$$

Equation 1: Noise Equation

$$NF = 10 \text{LOG} \left(\frac{e_n^2 + i_n^2 \left(R_{seq}^2 + (R_f || R_g)^2 \right) + 4kTR_{seq} + 4kT(R_f || R_g)}{4kTR_{seq}} \right)$$

Equation 2: Noise Figure Equation

The noise figure is related to the equivalent source resistance (R_{seq}) and the parallel combination of R_f and R_g . To minimize noise figure, the following steps are recommended:

- Minimize $R_f || R_g$
- Choose the optimum R_s (R_{OPT})

R_{OPT} is the point at which the NF curve reaches a minimum and is approximated by:

$$R_{OPT} \cong \frac{e_n}{i_n}$$

Figure 2 is a plot of NF vs R_s with $R_f = 0$, $R_g = \infty$ ($A_v = +1$). The NF curves for both Unterminated and Terminated systems are shown. The Terminated curve assumes $R_s = R_T$. The table indicates the NF for various source resistances including $R_s = R_{OPT}$.

Layout Considerations

A proper printed circuit layout is essential for achieving high frequency performance. Comlinear provides evaluation boards for the CLC440 (730055-DIP, 730060-SOIC) and suggests their use as a guide for high frequency layout and as an aid in device testing and characterization.

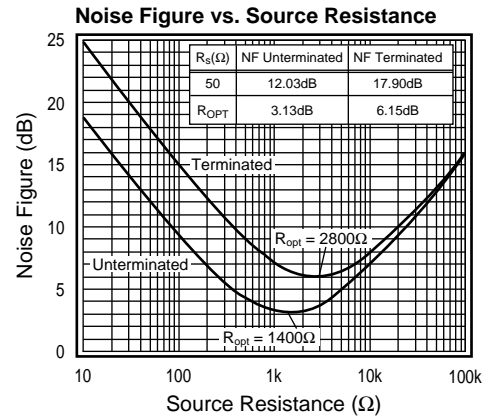

Figure 2: Noise Figure vs. Source Resistance

These boards were laid out for optimum, high-speed performance. The ground plane was removed near the input and output pins to reduce parasitic capacitance. And all trace lengths were minimized to reduce series inductances.

Supply bypassing is required for the amplifiers performance. The bypass capacitors provide a low impedance return current path at the supply pins. They also provide high frequency filtering on the power supply traces. 6.8μF tantalum, 0.01μF ceramic, and 500pF ceramic capacitors are recommended on both supplies. Place the 6.8μF capacitors within 0.75 inches of the power pins, and the 0.01μF and 500pF capacitors less than 0.1 inches from the power pins.

Dip sockets add parasitic capacitance and inductance which can cause peaking in the frequency response and overshoot in the time domain response. If sockets are necessary, flush-mount socket pins are recommended. The device holes in the 730055 evaluation board are sized for Cambion P/N 450-2598 socket pins, or their functional equivalent.

Applications Circuits

Transimpedance Amplifier

The low 2.5pA/√Hz input current noise and unity gain stability make the CLC440 an excellent choice for transimpedance applications. Figure 3 illustrates a low noise transimpedance amplifier that is commonly implemented with photo diodes. R_f sets the transimpedance gain. The photo diode current multiplied by R_f determines the output voltage.

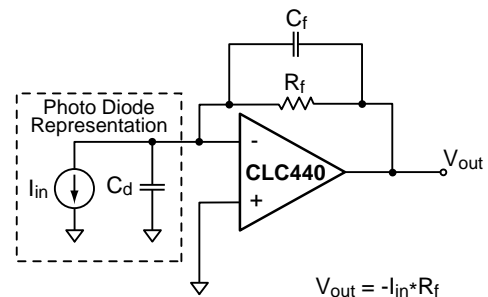

Figure 3: Transimpedance Amplifier Configuration

The capacitances are defined as:

- C_{in} = Internal Input Capacitance of the CLC440 (typ 1.2pF)
- C_d = Equivalent Diode Capacitance
- C_f = Feedback Capacitance

The transimpedance plot in the typical performance section provides the recommended C_f and expected bandwidth for different gains and diode capacitances. The feedback capacitances indicated on the plot give optimum gain flatness and stability. If a smaller capacitance is used, then peaking will occur. The frequency response shown in Figure 4 illustrates the influence of the feedback capacitance on gain flatness.

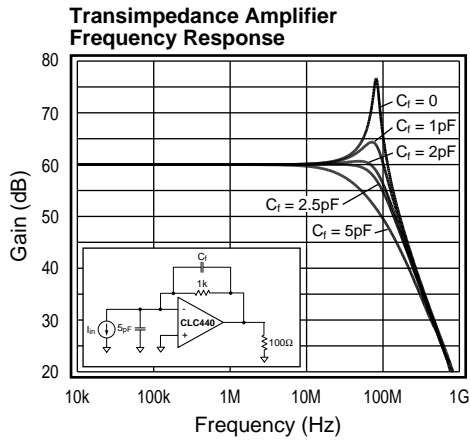

Figure 4

The total input current noise density (i_{ni}) for the basic transimpedance configuration is shown in Equation 3. The plot of current noise density versus feedback resistance is shown in Figure 5.

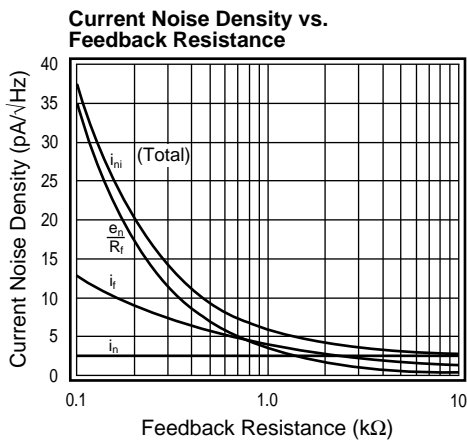

Figure 5

$$i_{ni} = \sqrt{i_n^2 + \left(\frac{e_{n2}}{R_f}\right)^2 + \frac{4kT}{R_f}}$$

Equation 3: Total Equivalent Input Referred Current Noise Density

Rectifier

The large bandwidth of the CLC440 allows for high speed rectification. A common rectifier topology is shown in Figure 6. R_1 and R_2 set the gain of the rectifier. V_{out} for a 5MHz, 2V_{pp} sinusoidal input is shown in Figure 7.

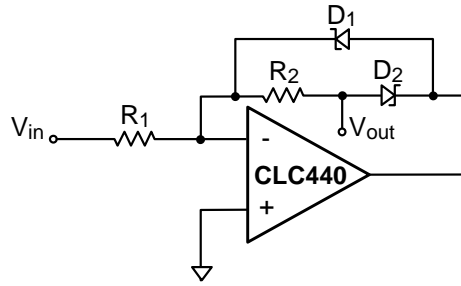

Figure 6: Rectifier Topology

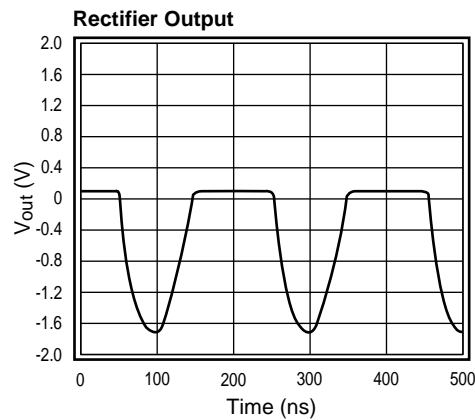

Figure 7: Rectifier Output

Tunable Low Pass Filter

The center frequency of the low pass filter (LPF) can be adjusted by varying the CLC522 gain control voltage, V_g .

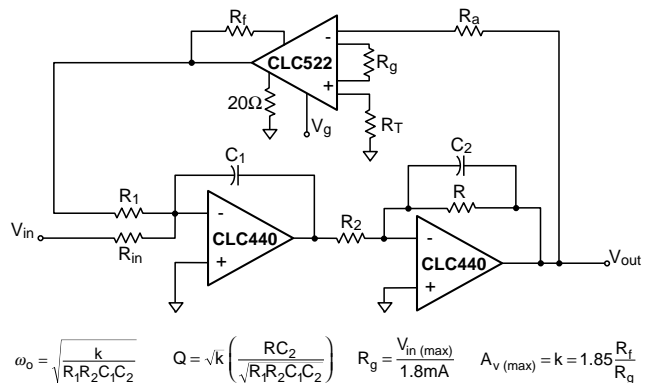

Figure 8: Tunable Low Pass Filter

This page intentionally left blank.

Customer Design Applications Support

National Semiconductor is committed to design excellence. For sales, literature and technical support, call the National Semiconductor Customer Response Group at **1-800-272-9959** or fax **1-800-737-7018**.

Life Support Policy

National's products are not authorized for use as critical components in life support devices or systems without the express written approval of the president of National Semiconductor Corporation. As used herein:

1. Life support devices or systems are devices or systems which, a) are intended for surgical implant into the body, or b) support or sustain life, and whose failure to perform, when properly used in accordance with instructions for use provided in the labeling, can be reasonably expected to result in a significant injury to the user.
2. A critical component is any component of a life support device or system whose failure to perform can be reasonably expected to cause the failure of the life support device or system, or to affect its safety or effectiveness.



National Semiconductor Corporation

1111 West Bardin Road
Arlington, TX 76017
Tel: 1(800) 272-9959
Fax: 1(800) 737-7018

National Semiconductor Europe

Fax: (+49) 0-180-530 85 86
E-mail: europe.support.nsc.com
Deutsch Tel: (+49) 0-180-530 85 85
English Tel: (+49) 0-180-532 78 32
Francais Tel: (+49) 0-180-532 93 58
Italiano Tel: (+49) 0-180-534 16 80

National Semiconductor Hong Kong Ltd.

13th Floor, Straight Block
Ocean Centre, 5 Canton Road
Tsimshatsui, Kowloon
Hong Kong
Tel: (852) 2737-1600
Fax: (852) 2736-9960

National Semiconductor Japan Ltd.

Tel: 81-043-299-2309
Fax: 81-043-299-2408

National does not assume any responsibility for use of any circuitry described, no circuit patent licenses are implied and National reserves the right at any time without notice to change said circuitry and specifications.