

Wideband Pre-amplifier

Description

The CXA3199TN is a wideband Pre-amplifier for VTR head.

Features

- Operate on single +3.3 V power supply
- Low power consumption
 Read : 45 mW
- Ultra small package
- Wideband (−3 dB) : 140 MHz (typ)
- Read amplifier emitter follower output featuring 380 times gain (typ).
- Low input capacitance : 3.0 pF
- Low input noise : 0.65 nV /√Hz
- Read data outputs are high impedance in Power Saving Mode

Structure

Bipolar silicon monolithic IC

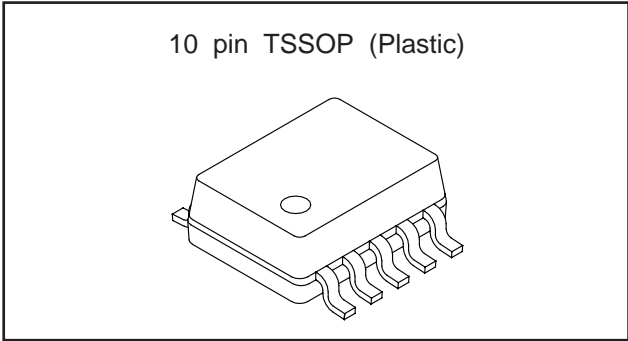

Absolute Maximum Ratings (Ta=25 °C)

• Supply voltage	V _{cc}	6	V
• Operating temperature	T _{opr}	−20 to +70	°C
• Storage temperature	T _{stg}	−55 to +150	°C
• Allowable power dissipation (on board)	P _D	1000	mW

Operating Conditions

Supply voltage	V _{cc}	3.1 to 5.5	V
----------------	-----------------	------------	---

Block Diagram and Pin Configuration

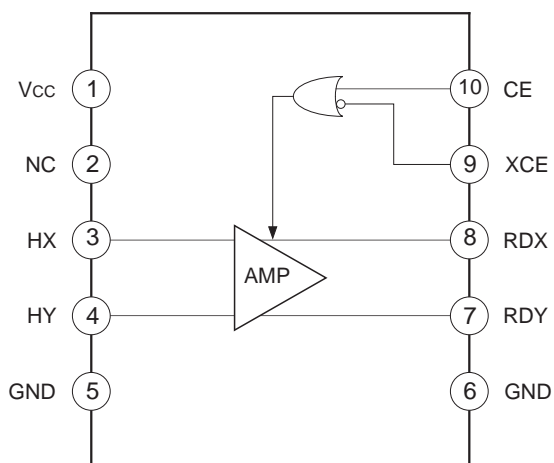

Sony reserves the right to change products and specifications without prior notice. This information does not convey any license by any implication or otherwise under any patents or other right. Application circuits shown, if any, are typical examples illustrating the operation of the devices. Sony cannot assume responsibility for any problems arising out of the use of these circuits.

Pin Description

No.	Symbol	Equivalent circuit	Description
1	Vcc		
3 4	H0X H0Y		Head.
5 6	GND		
7 8	RDY RDX		Read amplifier output.
9	XCE		Power Save signal input.
10	CE		Power Save signal input.

Electrical Characteristics

(Unless otherwise specified, $V_{CC}=3.3\text{ V}$, $T_a=25\text{ }^\circ\text{C}$)

Item	Symbol	Test condition	Min.	Typ.	Max.	Unit.
Current consumption for read	I_{CCR}		8.0	13.5	*19.5	mA
Current consumption for chip disenable	I_{CCXCE}		0.3	0.5	0.8	mA
Digital input "Low" input voltage	V_{IL}				0.8	V
Digital input "High" input voltage	V_{IH}		2.0			V
Digital input "Low" input current	I_{IL}	"H" applied voltage: 3.3 V "L" applied voltage: 0 V	-100			μA
Digital input "High" input current	I_{IH}				100	μA
Read amplifier differential voltage gain	A_V	Input voltage : 1 mVp-p, 300 kHz	300	380	460	V/V
Frequency band width (-3 dB)	B_W	Frequency at which A_V lower by 3 dB	100	145		MHz
Input referred noise voltage	E_N	Head impedance : 0 Ω		0.65	0.8	$\frac{\text{nV}}{\sqrt{\text{Hz}}}$
Common mode rejection ratio	$CMRR$	Common input voltage : 100 mVp-p, 20 MHz	50			dB
Supply voltage rejection ratio	$PSRR$	Ripple voltage : 100 mVp-p, 20 MHz	50			dB
Read data output offset voltage for Read	V_{OFFR}	$V_{OFFR}=V_{RDX}-V_{RDY}$, A version	-300		300	mV
Chip disenable to read	T_{IR}				500	ns
Differential input capacitance	C_{IN}			3.0	4.5	pF
Differential input resistance	R_{IN}		0.8	2.1	3.5	k Ω
Output resistance	R_{RD}	RDX or RDY	10.0	20.0	35.0	Ω
Read data output sink current	I_{sink}		2.0	3.0	4.1	mA

* Guaranteed until $T_a=70\text{ }^\circ\text{C}$

Timing Chart

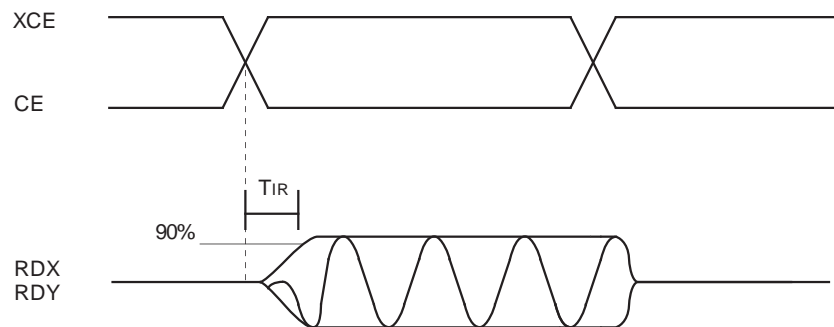

Description of Functions

Pre-amplifier

This is a low noise amplifier for amplifying the signals from the heads with an emitter follower output.

The RDX and RDY are the outputs of the differential amplifier whose polarity between the RDX and X side of the head input is same.

Mode control

The mode are set as shown Table 1 by CE and XCE.

CE	XCE	Mode
H	L	Read
H	H	
L	L	
L	H	Power saving

Table 1. Mode selection

Application Circuit

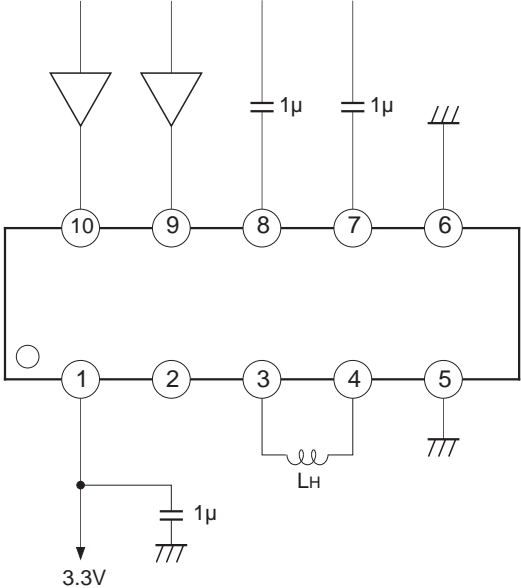

Application circuits shown are typical examples illustrating the operation of the devices. Sony cannot assume responsibility for any problems arising out of the use of these circuits or for any infringement of third party patent and other right due to same.

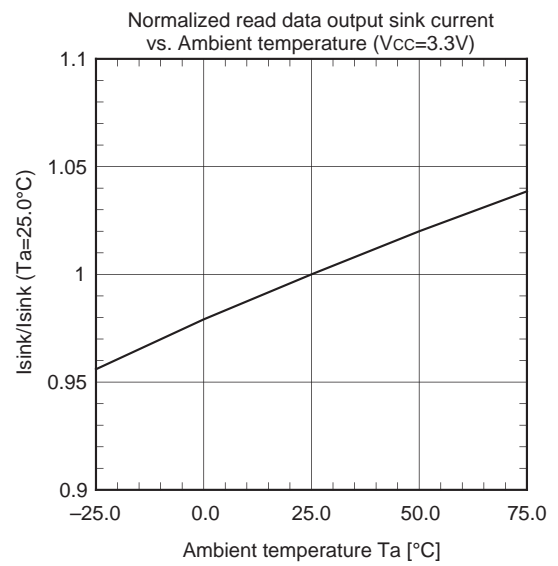
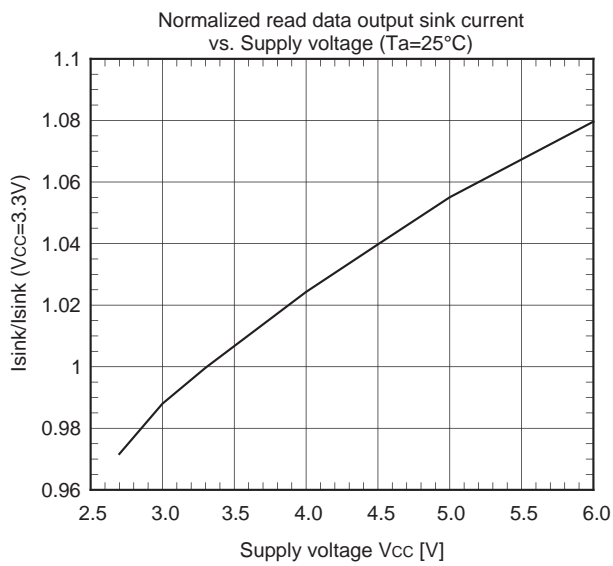
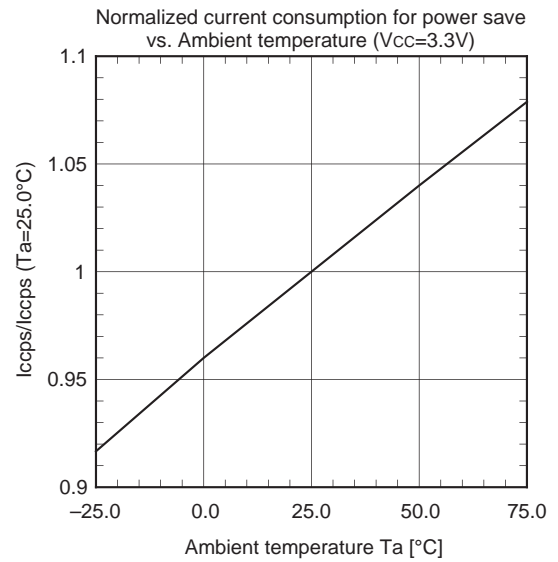
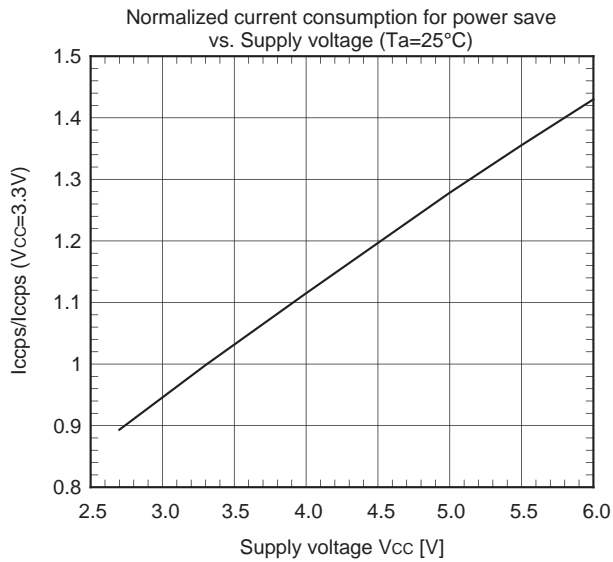
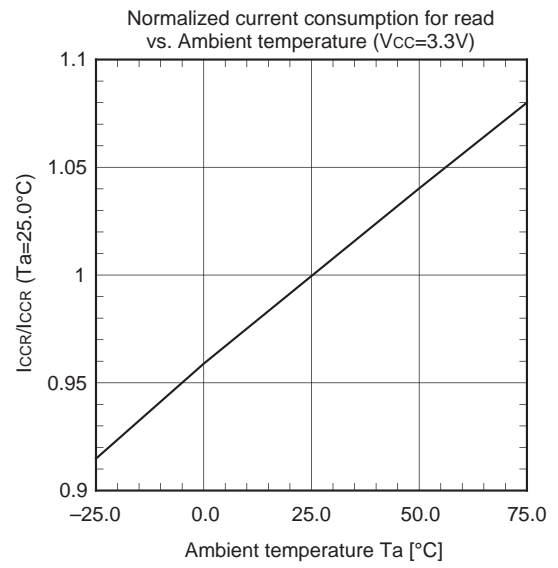
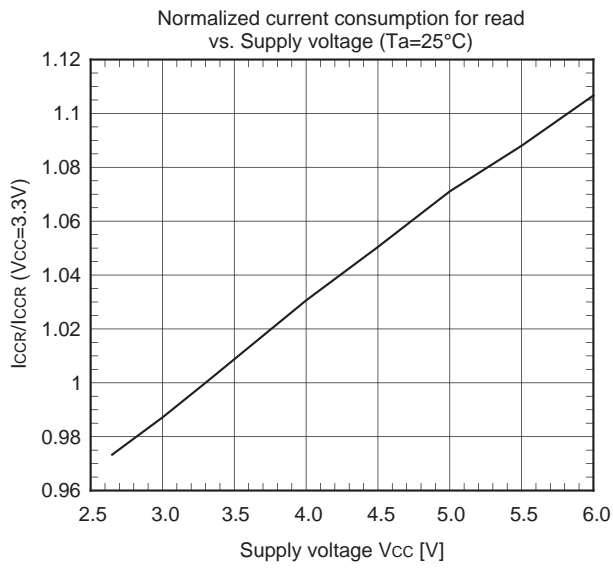

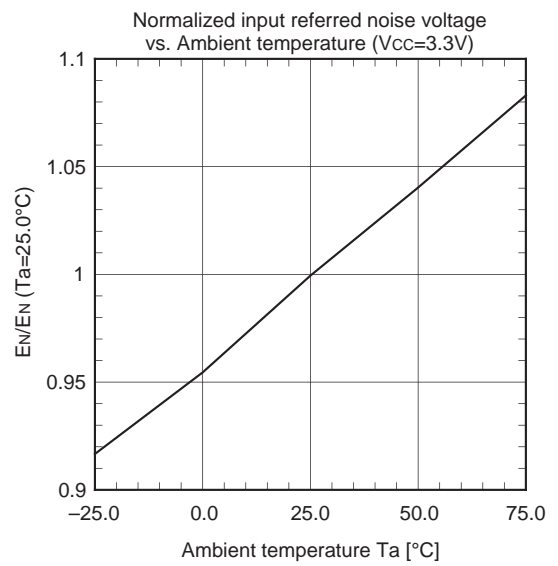
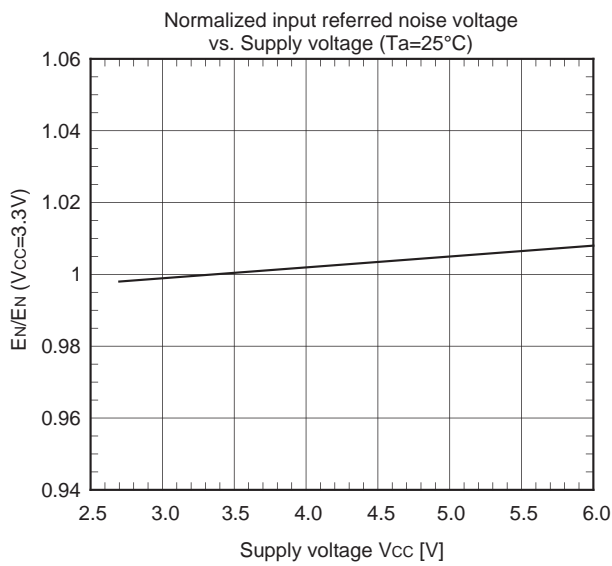
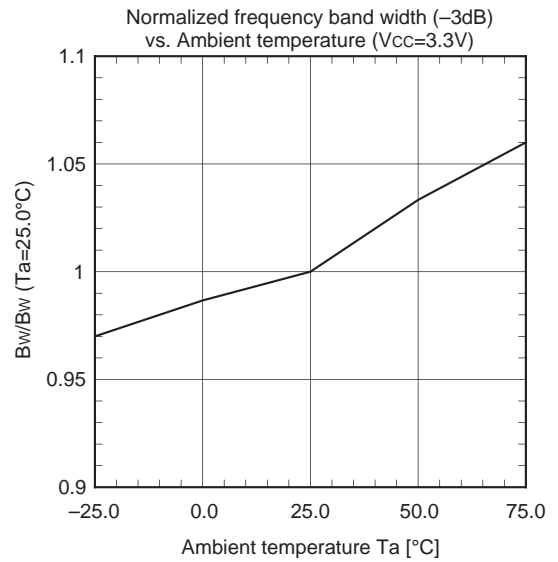
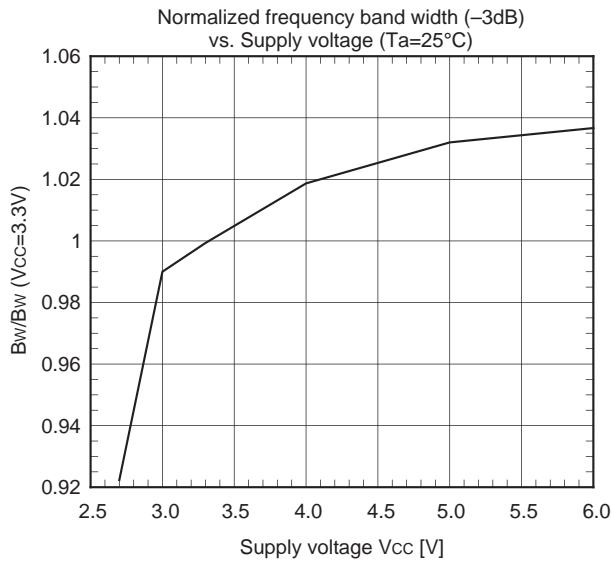
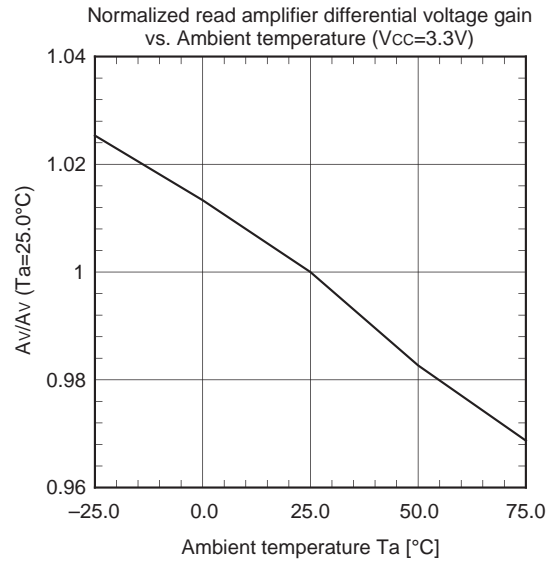
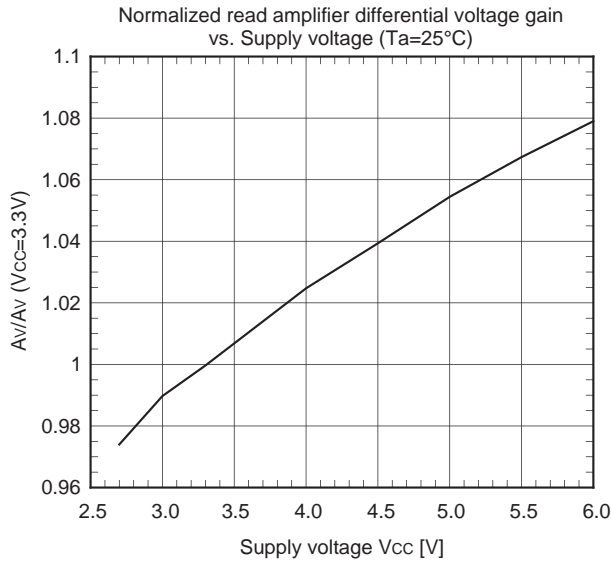

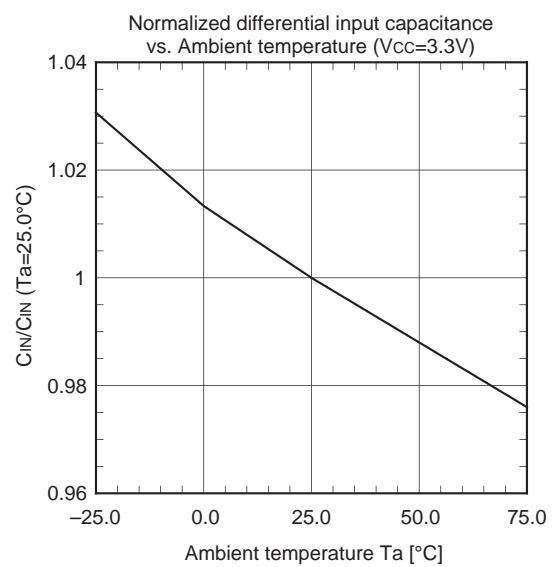
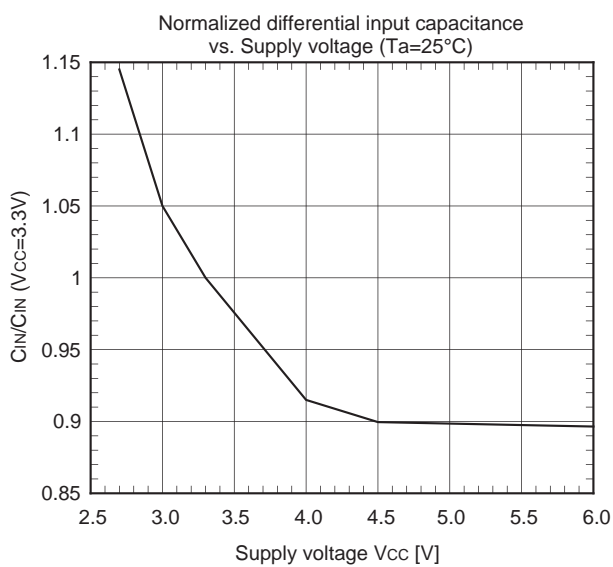
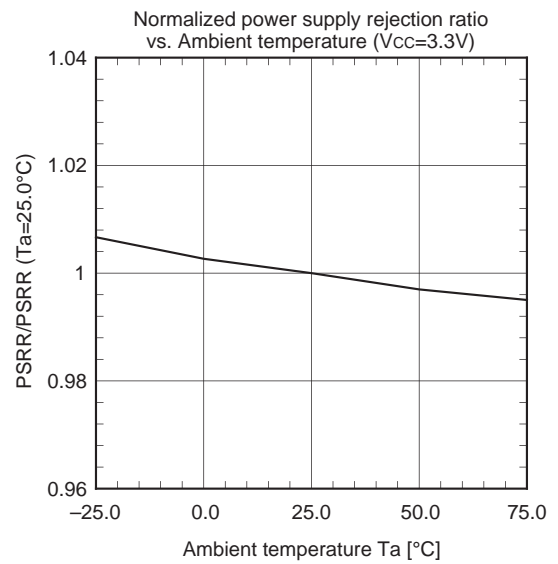
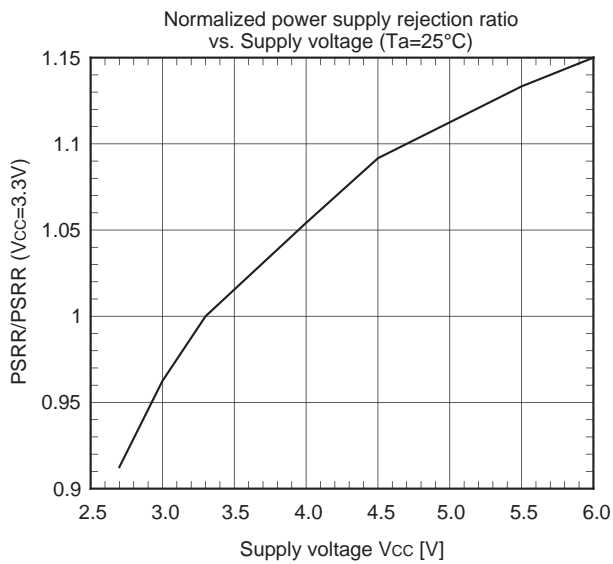
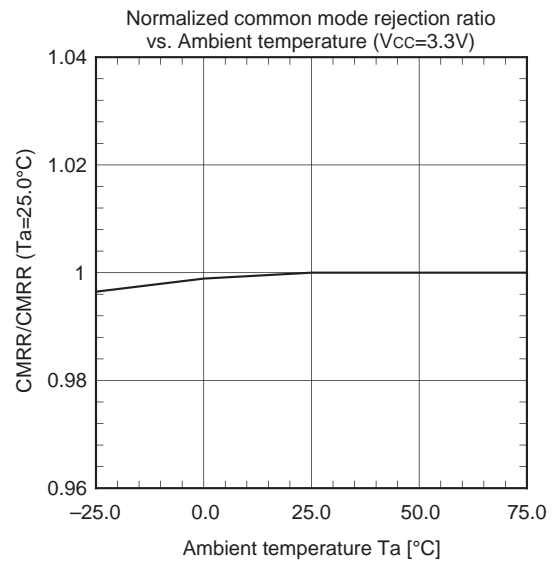
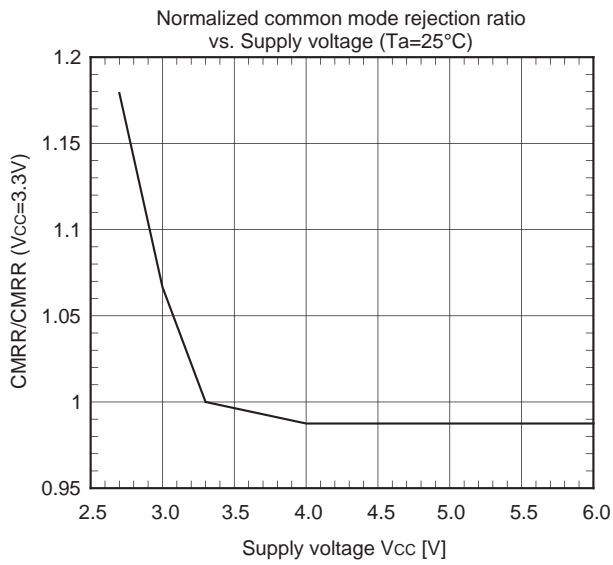

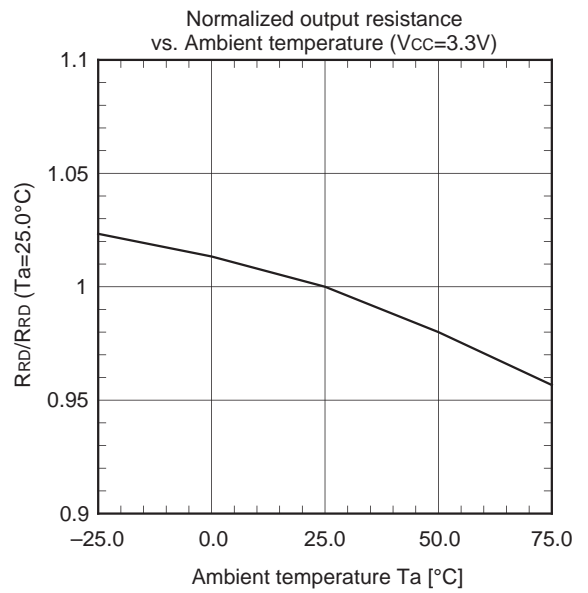
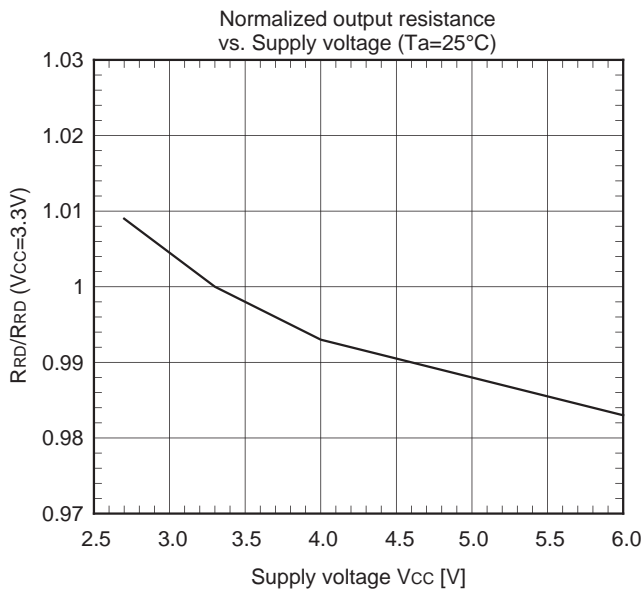
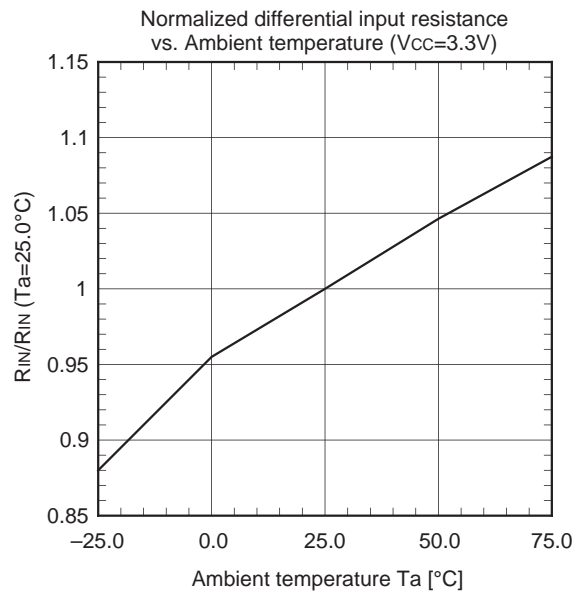
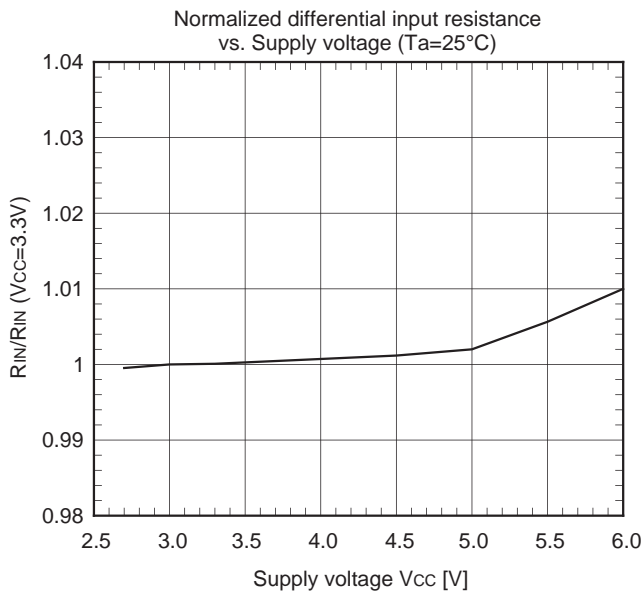

Package Outline Unit : mm

10PIN TSSOP(PLASTIC)

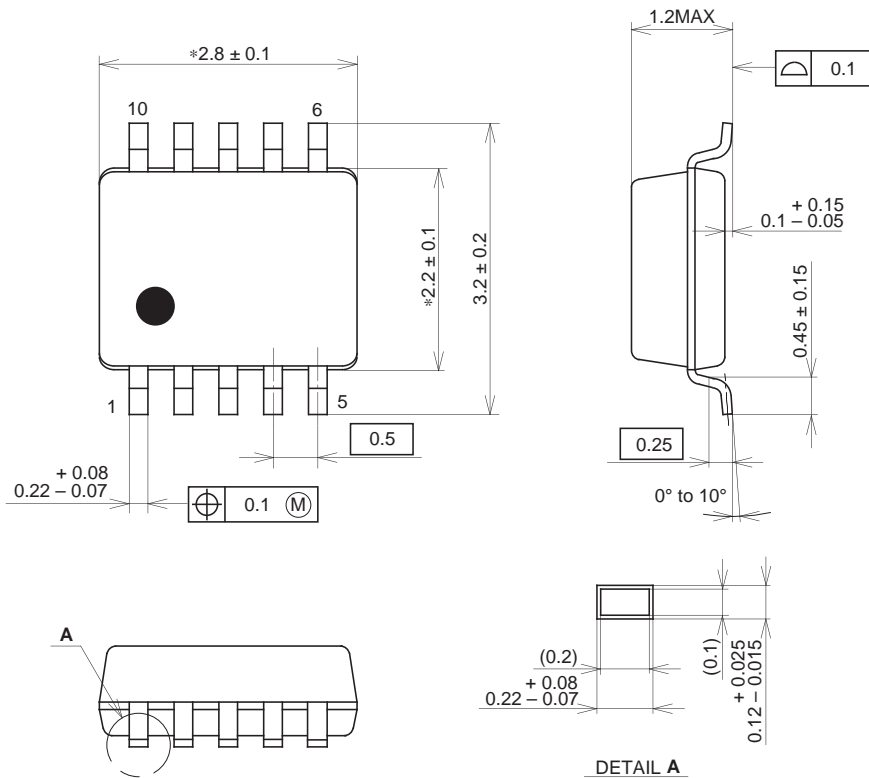

NOTE: Dimension "*" does not include mold protrusion.

PACKAGE STRUCTURE

SONY CODE	TSSOP-10P-L01
EIAJ CODE	_____
JEDEC CODE	_____

PACKAGE MATERIAL	EPOXY RESIN
LEAD TREATMENT	SOLDER PLATING
LEAD MATERIAL	COPPER ALLOY
PACKAGE MASS	0.02g