



High IMR, Low Cost ISOLATION AMPLIFIER

FEATURES

- HIGH ISOLATION-MODE REJECTION:
10kV/ μ s (min)
- LARGE SIGNAL BANDWIDTH: 85kHz (typ)
- DIFFERENTIAL INPUT/DIFFERENTIAL OUTPUT
- VOLTAGE OFFSET DRIFT vs
TEMPERATURE: 4.6 μ V/ $^{\circ}$ C (typ)
- OFFSET VOLTAGE 1.8mV (max)
- INPUT REFERRED NOISE: 300 μ Vrms (typ)
- NONLINEARITY: 0.25% (max)
- SINGLE SUPPLY OPERATION
- SIGMA-DELTA A/D CONVERTER
TECHNOLOGY
- WORLDWIDE SAFETY APPROVAL:
UL1577 (File No. E162573), VDE0884
(File No. 85511), CSA22.2 (File No. 88324)
- AVAILABLE IN 8-PIN PLASTIC DIP and
8-PIN GULL-WING PLASTIC SURFACE MOUNT

APPLICATIONS

- MOTOR AND SCR CONTROL
- MOTOR PHASE CURRENT SENSING
- INDUSTRIAL PROCESS CONTROL:
Transducer Isolator, Isolator for
Thermocouples, RTDs
- GENERAL PURPOSE ANALOG SIGNAL
ISOLATION
- POWER MONITORING
- GROUND LOOP ELIMINATION

DESCRIPTION

The ISO130 is a high isolation-mode rejection, isolation amplifier suited for motor control applications. Its versatile design provides the precision and stability needed to accurately monitor motor currents in high-noise motor control environments. The ISO130 can also be used for general analog signal isolation applications requiring stability and linearity under severe noise conditions.

The signal is transmitted digitally across the isolation barrier optically, using a high-speed AlGaAs LED. The remainder of the ISO130 is fabricated on 1 μ m CMOS IC process. A sigma-delta analog-to-digital converter, chopper stabilized amplifiers and differential input and output topologies make the isolation amplifier suitable for a variety of applications.

The ISO130 is easy to use. No external components are required for operation. The key specifications are 10kV/ μ s isolation-mode rejection, 85kHz large signal bandwidth, and 4.6 μ V/ $^{\circ}$ C V_{OS} drift. A single power supply ranging from +4.5V to +5.5V makes this amplifier ideal for low power isolation applications.

The ISO130 is available in 8-pin plastic DIP and 8-pin plastic gull-wing surface mount packages.

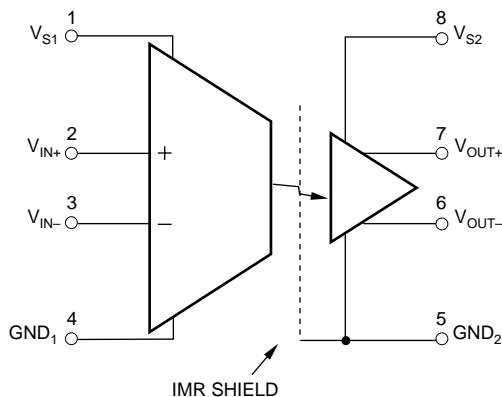

Please be aware that an important notice concerning availability, standard warranty, and use in critical applications of Texas Instruments semiconductor products and disclaimers thereto appears at the end of this data sheet.

PIN CONFIGURATION

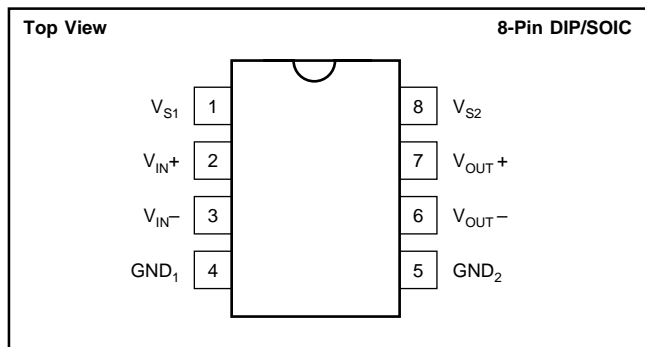

ELECTROSTATIC DISCHARGE SENSITIVITY

This integrated circuit can be damaged by ESD. Texas Instruments recommends that all integrated circuits be handled with appropriate precautions. Failure to observe proper handling and installation procedures can cause damage.

ESD damage can range from subtle performance degradation to complete device failure. Precision integrated circuits may be more susceptible to damage because very small parametric changes could cause the device not to meet its published specifications.

ABSOLUTE MAXIMUM RATINGS

Supply Voltages: V_{S1} , V_{S2}	0V to 5.5V
Steady-State Input Voltage	-2V to $V_{S1} + 0.5V$
2 Second Transient Input Voltage	-6.0V
Output Voltages: V_{OUT+} , V_{OUT-}	-0.5V to $V_{S2} + 0.5V$
Lead Temperature Solder (1.6mm below seating plane, 10s)	260°C

PACKAGE INFORMATION

PRODUCT	PACKAGE	PACKAGE DRAWING NUMBER ⁽¹⁾
ISO130P	8-Pin Plastic DIP	006-3
ISO130PB	8-Pin Plastic DIP	006-3
ISO130U	8-Pin Gull-Wing Plastic Surface Mount	006-2
ISO130UB	8-Pin Gull-Wing Plastic Surface Mount	006-2

NOTE: (1) For detailed drawing and dimension table, please see end of data sheet, or Appendix C of Burr-Brown IC Data Book.

ORDERING INFORMATION

PRODUCT	PACKAGE	GAIN ERROR (MAX)
ISO130P	8-Pin Plastic DIP	±5% (mean value = 8.00)
ISO130PB	8-Pin Plastic DIP	±1% (mean value = 7.93)
ISO130U	8-Pin Gull-Wing Plastic Surface Mount	±5% (mean value = 8.00)
ISO130UB	8-Pin Gull-Wing Plastic Surface Mount	±1% (mean value = 7.93)

ELECTRICAL CHARACTERISTICS

ISOLATION SPECIFICATIONS – VDE0884 INSULATION CHARACTERISTICS

At V_{IN-} , $V_{IN+} = 0V$, $T_A = 25^\circ C$, V_{S1} , $V_{S2} = 5.0V$, unless otherwise noted.

PARAMETER	CONDITIONS	ISO130P, ISO130PB ISO130U, ISO130UB			UNITS
		CHARACTERISTIC			
ISOLATION CHARACTERISTICS					
Installation Classification Table I	As Per VDE0109/12.83		I-IV I-III		
Rated Mains Voltage $\leq 300V_{rms}$			40/85/21		
Rated Mains Voltage $\leq 600V_{rms}$			2		
Climatic Classification					
Pollution Degree ⁽¹⁾	As Per VDE0109/12.83				
Maximum Working Insulation Voltage (V_{IORM})			600		V_{rms}
Side A to Side B Test Voltage, Method b (V_{PR}) ⁽⁹⁾					
Partial Discharge $< 5pC$	$V_{PR} = 1.6 \times V_{IORM}$, $t_P = 1s$		960		V_{rms}
Side A to Side B Test Voltage, Method a (V_{PR}) ⁽⁹⁾	Type and Sample Test				
Partial Discharge $< 5pC$	$V_{PR} = 1.2 \times V_{IORM}$, $t_P = 60s$		720		V_{rms}
Highest Allowable Overvoltage (V_{TR}) ⁽⁹⁾	Transient Overvoltage, $t_{TR} = 10s$		6000		V_{PEAK}
Safety-Limiting Values					
Case Temperature (T_{SI})			175		$^\circ C$
Input Power ($P_{SI (INPUT)}$)			80		mW
Output Power ($P_{SI (OUTPUT)}$)			250		mW
INSULATION RELATED SPECIFICATIONS					
Min. External Air Gap (clearance)			> 7		mm
Min. External Tracking Path (creepage)			8		mm
Internal Isolation Gap (clearance)			0.5		mm
Tracking Resistance (CTI)			175		V
Isolation Group	per VDE0109		III a		
Insulation Resistance	$25^\circ C$, $V_{ISO} = 500V$		$\geq 10^{11}$		Ω

ELECTRICAL CHARACTERISTICS

ISOLATION SPECIFICATIONS

At V_{IN+} , $V_{IN-} = 0V$, $T_A = 25^\circ C$, V_{S1} , $V_{S2} = 5.0V$, unless otherwise noted.

PARAMETER	CONDITIONS	ISO130P, ISO130PB ISO130U, ISO130UP			UNITS
		MIN	TYP	MAX	
ISOLATION					
Input-Output Surge Withstand Voltage ^(8, 9) , (In accordance with UL1577)	$t = 1_{MIN}$, $RH \leq 50\%$	3750			V_{rms}
Barrier Impedance ⁽⁹⁾					
Resistance	$V_{ISO} = 500VDC$		10^{13}		Ω
Capacitance	$f = 1MHz$		0.7		pF
Isolation Mode Voltage Errors					
Rising Edge Transient Immunity	$V_{IM} = 1kV$, $\partial V_{OUT} < 50mV$	10	25		$kV/\mu s$
Falling Edge Transient Immunity	$V_{IM} = 1kV$, $\partial V_{OUT} < 50mV$	10	15		$kV/\mu s$
Isolation Mode Rejection Ratio ⁽²⁾			> 140		dB

ELECTRICAL CHARACTERISTICS

At V_{IN+} , $V_{IN-} = 0V$, $T_A = 25^\circ C$, V_{S1} , $V_{S2} = 5.0V$, unless otherwise noted.

PARAMETER	CONDITIONS	ISO130P, ISO130PB ISO130U, ISO130UB			UNITS	
		MIN	TYP	MAX		
INPUT						
Initial Offset Voltage vs Temperature vs V_{S1} vs V_{S2} Power Supply Rejection; V_{S1} and V_{S2} Together Noise	1MHz Square Wave, 5ns Rise/Fall Time 0.1Hz to 100kHz	-1.8	-0.9 4.6 30 -40	0.0	mV $\mu V/^\circ C$ $\mu V/V$ $\mu V/V$	
Input Voltage Range		-200	5 300	200	mV/V μV_{rms}	
Maximum Input Voltage Range before Output Clipping			± 300		mV	
Initial Input Bias Current ⁽³⁾ vs Temperature			-670 3		nA $nA/^\circ C$	
Input Resistance ⁽³⁾ vs Temperature			530 0.38		k Ω $\%/^\circ C$	
Common-Mode Rejection Ratio ⁽⁴⁾			72		dB	
GAIN⁽⁵⁾						
Initial Gain ISO130P/ISO130U ISO130PB/ISO130UB		$-200mV < V_{IN+} < 200mV$ $-200mV < V_{IN+} < 200mV$	7.61 7.85	8.00 7.93	8.40 8.01	V/V V/V
Gain vs Temperature				10		ppm/ $^\circ C$
Gain vs V_{S1} Gain vs V_{S2}				2.1 -0.6		ppm/mV ppm/mV
Gain Nonlinearity for $-200mV < V_{IN+} < 200mV$ for $-100mV < V_{IN+} < 100mV$ vs Temperature ⁽⁶⁾ vs V_{S1} ⁽⁶⁾ vs V_{S2} ⁽⁶⁾	$-200mV < V_{IN+} < 200mV$ $-200mV < V_{IN+} < 200mV$ $-200mV < V_{IN+} < 200mV$		0.2 0.1 -0.001 -0.005 -0.007	0.35 0.25	% % $\% pts/^\circ C$ $\% pts/V$ $\% pts/V$	
OUTPUT						
Voltage Range High Low Common-Mode Voltage	$V_{IN+} = +500mV$ $V_{IN+} = -500mV$ $-40^\circ C < T_A < 85^\circ C$, $4.5V < V_{S1} < 5.5V$		3.61 1.18 2.39		V V V	
Current Drive ⁽⁷⁾		2.2	1	2.6	mA	
Short-Circuit Current	$V_{OUT} = 0V$ or $V_{OUT} = V_{S2}$		9.3		mA	
Output Resistance vs Temperature			11 0.6		Ω $\%/^\circ C$	
FREQUENCY RESPONSE						
Bandwidth -3dB -45 $^\circ$	$-40^\circ C$ to $85^\circ C$	50	85 35		kHz kHz	
Rise/Fall Time (10% - 90%)	$-40^\circ C$ to $85^\circ C$		4.3	6.6	μs	
Propagation Delay to 10% to 50% to 90%	$-40^\circ C$ to $85^\circ C$ $-40^\circ C$ to $85^\circ C$ $-40^\circ C$ to $85^\circ C$		2.0 3.4 6.3	3.3 5.6 9.9	μs μs μs	
POWER SUPPLIES						
Rated Voltage			5.0		V	
Voltage Range		4.5		5.5	V	
Quiescent Current V_{S1} V_{S2}	$V_{IN+} = 200mV$, $-40^\circ C < T_A < 85^\circ C$, $4.5V < V_{S1} < 5.5V$ $-40^\circ C < T_A < 85^\circ C$, $4.5V < V_{S1} < 5.5V$		10.7 11.6	15.5 15.5	mA mA	
TEMPERATURE RANGE						
Specification		-40		85	$^\circ C$	
Operating		-40		100	$^\circ C$	
Storage		-55		125	$^\circ C$	
θ_{C-A}			86		$^\circ C/W$	

NOTES: (1) This part may also be used in Pollution Degree 3 environments where the rated mains voltage is 300Vrms (per DIN VDE0109/12.83). (2) IMRR = $20 \log (\partial V_{IN} / \partial V_{ISO})$. (3) Time averaged value. (4) $V_{IN+} = V_{IN-} = V_{CM}$. CMRR = $20 \log (\partial V_{CM} / \partial V_{OS})$. (5) The slope of the best-fit line of $(V_{OUT+} - V_{OUT-})$ vs $(V_{IN+} - V_{IN-})$. (6) Change in nonlinearity vs temperature or supply voltage expressed in number of percentage points per $^\circ C$ or volt. (7) For best offset voltage performance. (8) For devices with minimum V_{ISO} specified at 3750Vrms, each isolation amplifier is proof-tested by applying an insulation test voltage $\geq 4500V_{rms}$ for 1 second (leakage current $< 5\mu A$). This specification does not guarantee continuous operation. (9) Pins 1-4 are shorted together and pins 5-8 are shorted together for this test.

TYPICAL CHARACTERISTICS

At $T_A = 25^\circ\text{C}$, $V_{S1}, V_{S2} = 5.0\text{V}_{\text{DC}}$, $V_{\text{IN}+}, V_{\text{IN}-} = 0\text{V}$, unless otherwise noted.

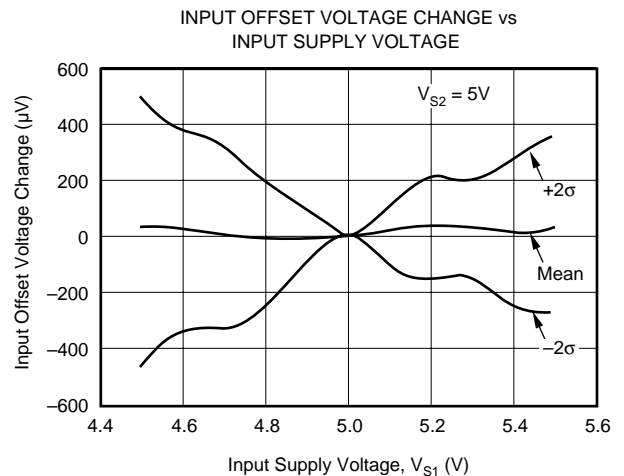
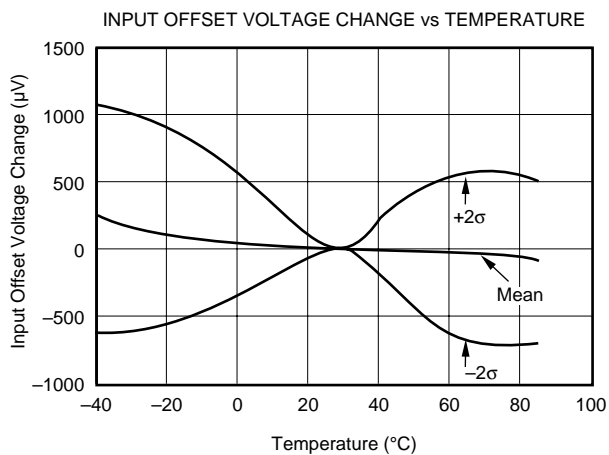
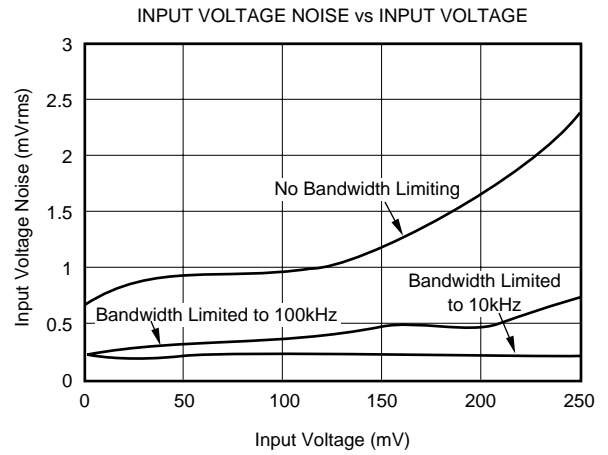
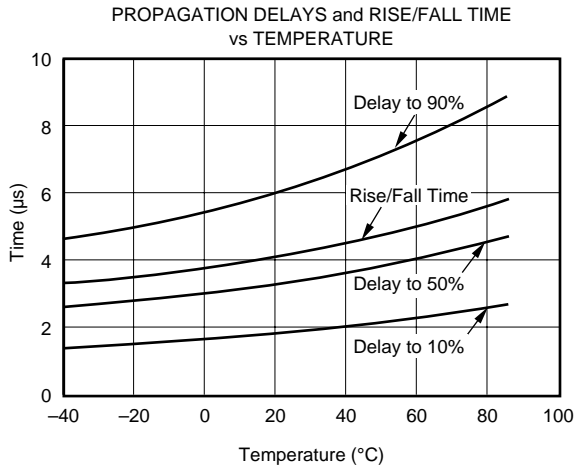
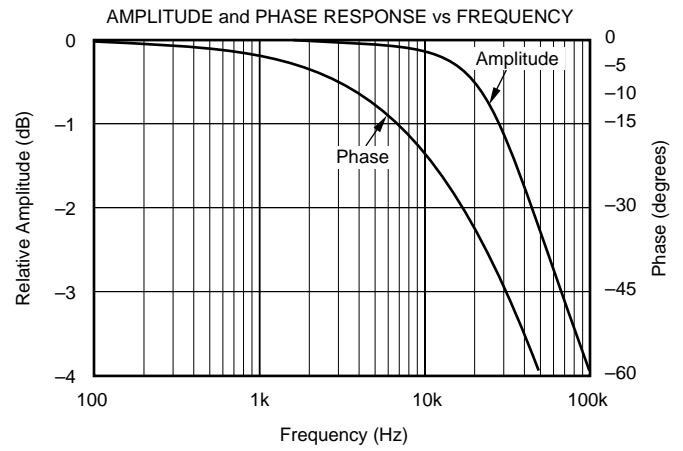
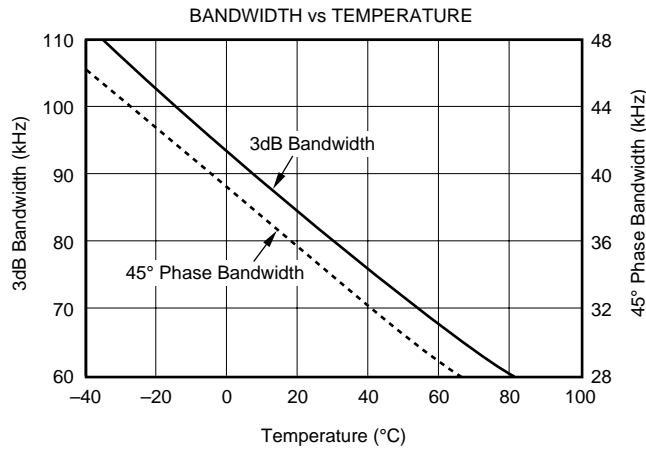

TYPICAL CHARACTERISTICS (Cont.)

At $T_A = 25^\circ\text{C}$, $V_{S1}, V_{S2} = 5.0V_{DC}$, $V_{IN+}, V_{IN-} = 0V$, unless otherwise noted.

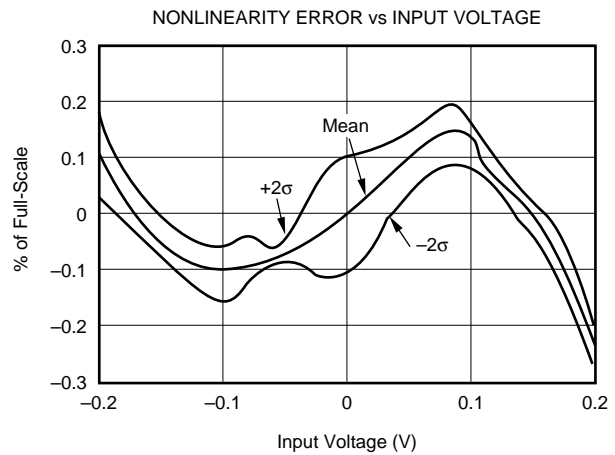
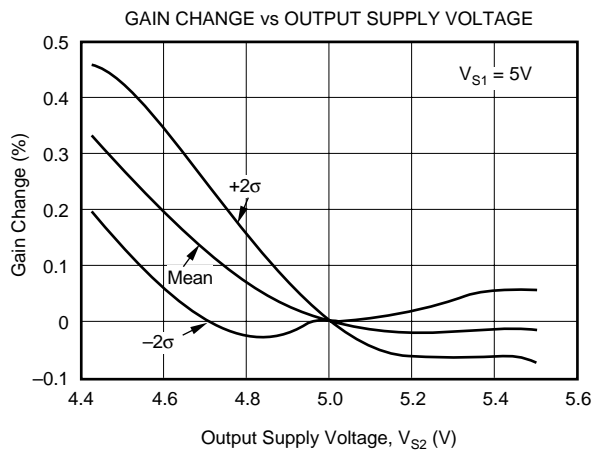
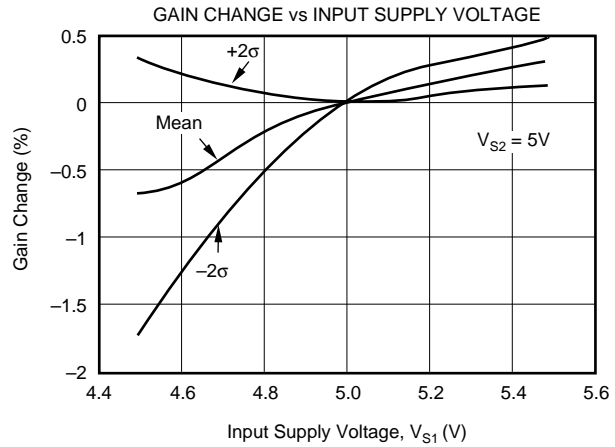
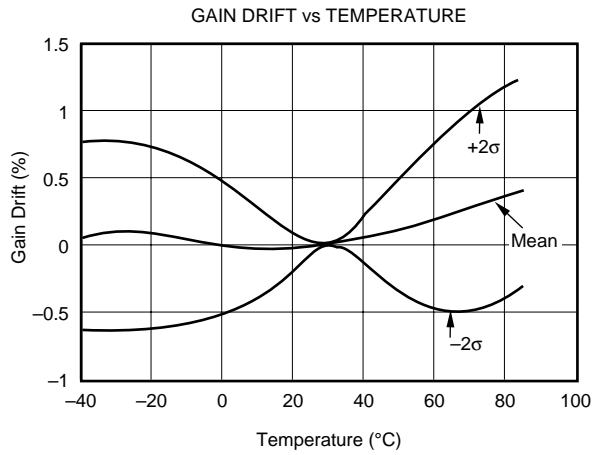
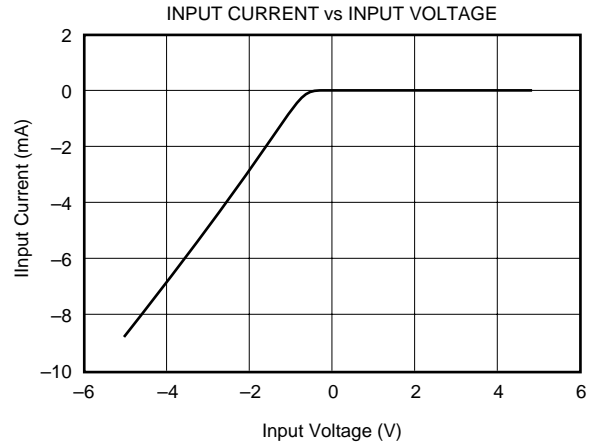
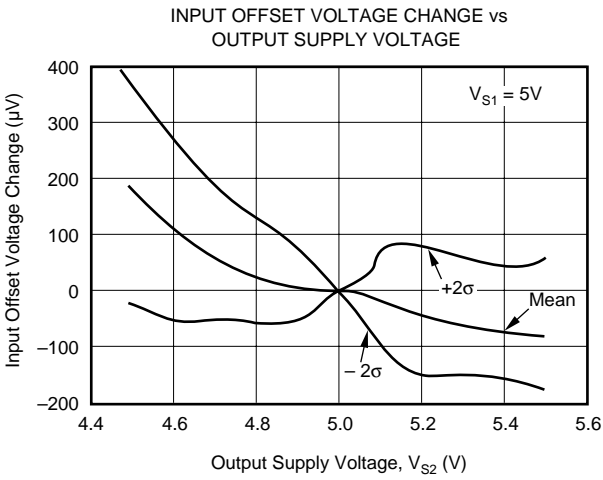

TYPICAL CHARACTERISTICS (Cont.)

At $T_A = 25^\circ\text{C}$, $V_{S1}, V_{S2} = 5.0\text{V}_{\text{DC}}$, $V_{\text{IN}+}, V_{\text{IN}-} = 0\text{V}$, unless otherwise noted.

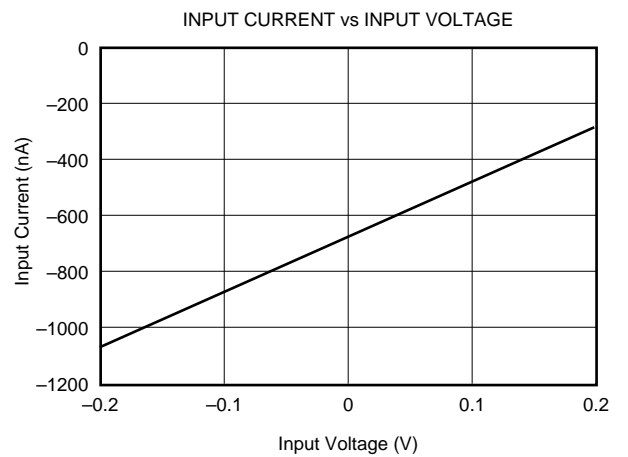
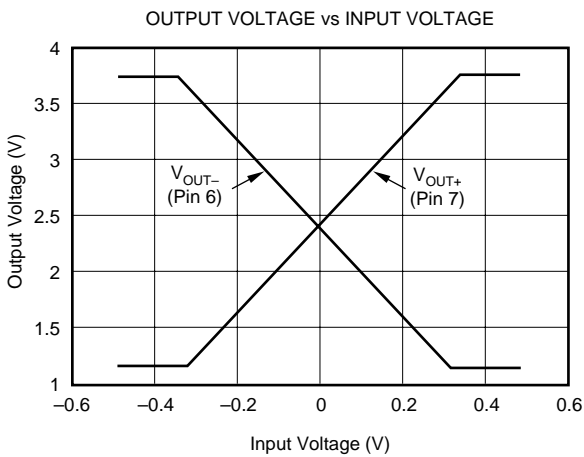
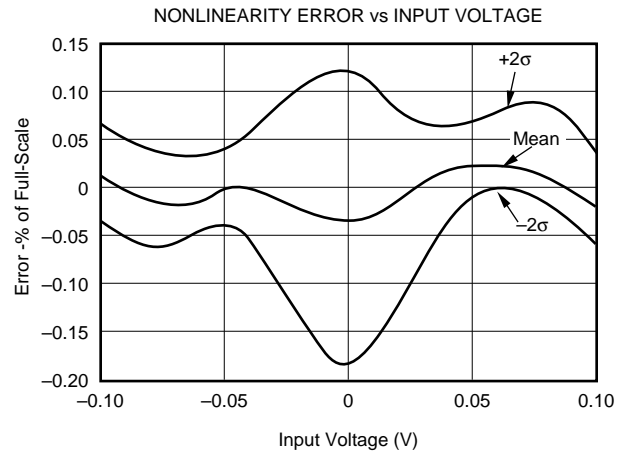
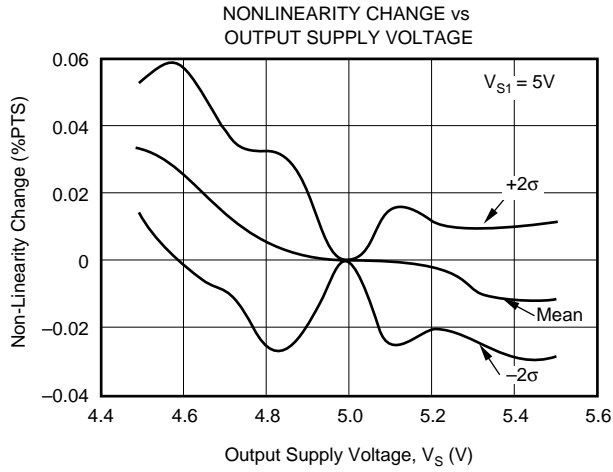
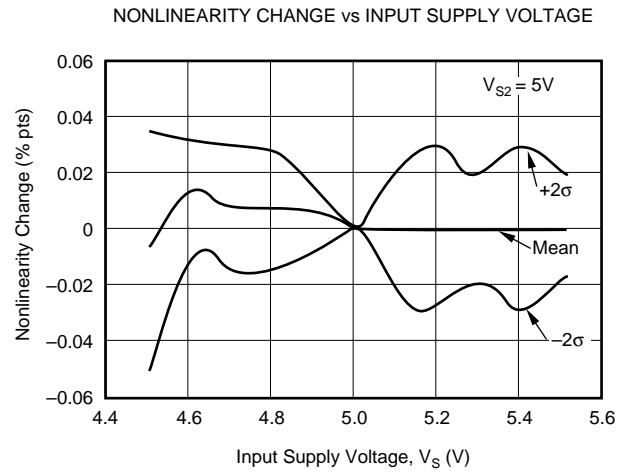
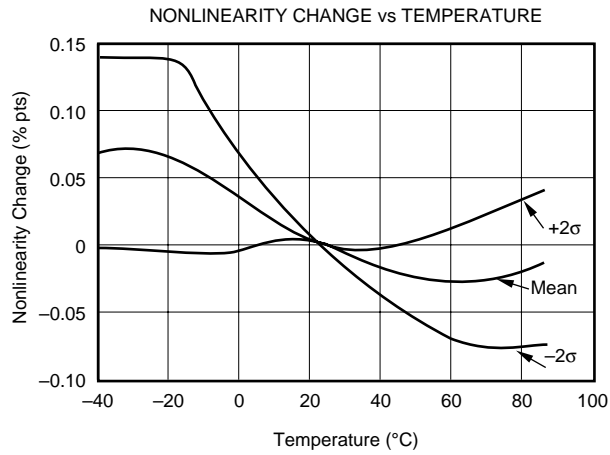

TYPICAL CHARACTERISTICS (Cont.)

At $T_A = 25^\circ\text{C}$, $V_{S1}, V_{S2} = 5.0V_{DC}$, $V_{IN+}, V_{IN-} = 0V$, unless otherwise noted.

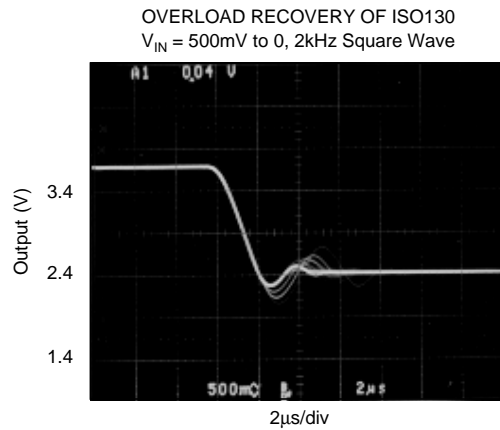
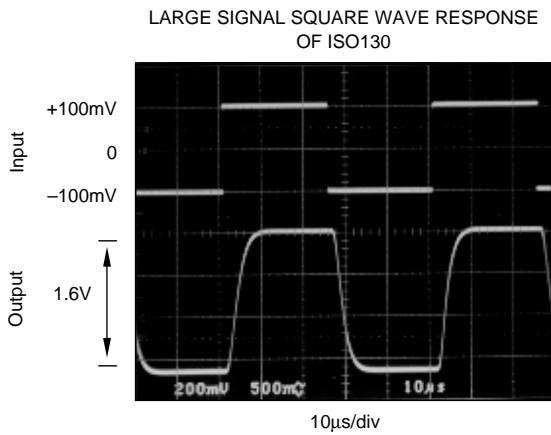
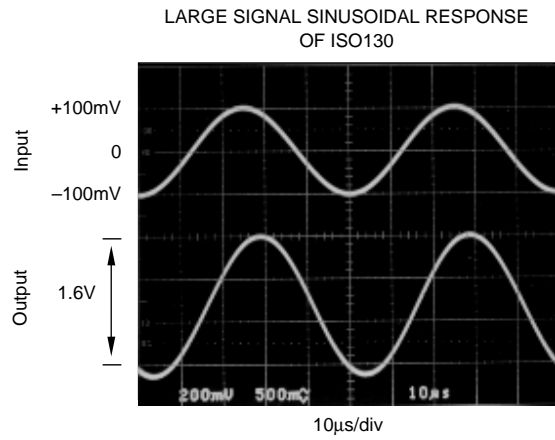
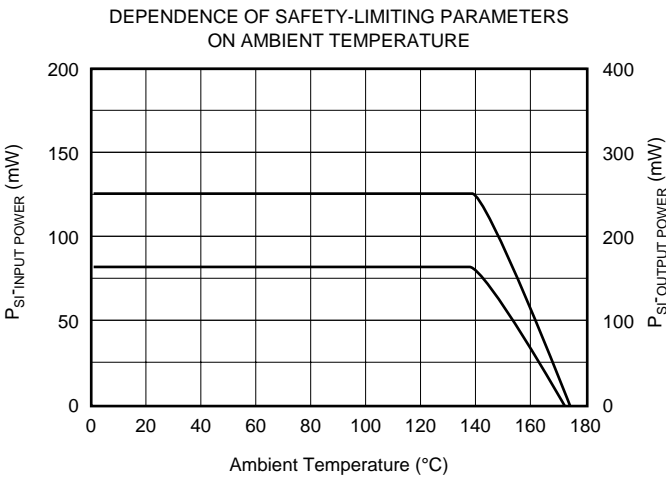
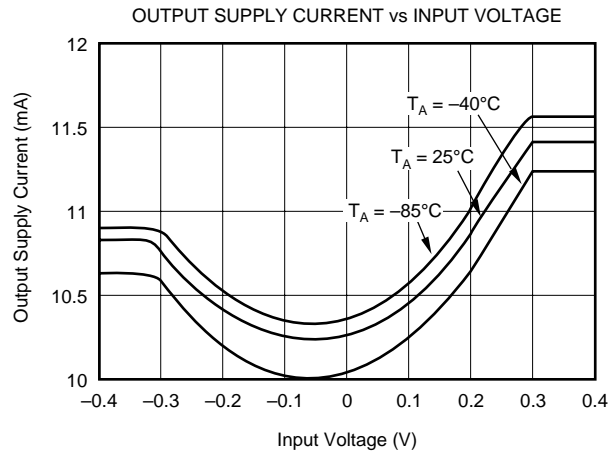
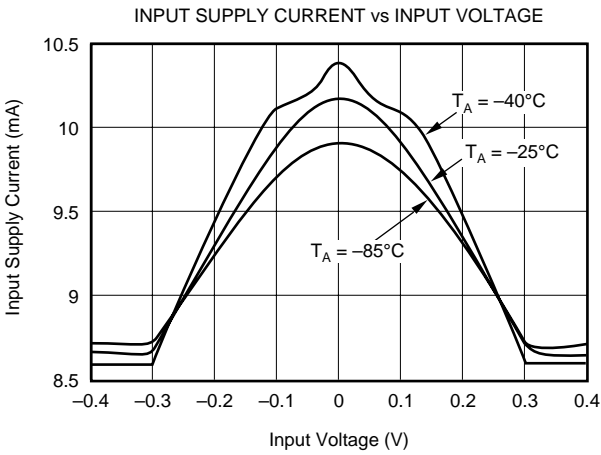

THEORY OF OPERATION

The ISO130 isolation amplifier (Figure 1) uses an input and output section galvanically isolated by a high speed optical barrier built into the plastic package. The input signal is converted to a time averaged serial bit stream by use of a sigma-delta analog-to-digital converter and then optically transmitted digitally across the isolation barrier. The output section receives the digital signal and converts it to an analog voltage, which is then filtered to produce the final output signal.

Internal amplifiers are chopper-stabilized to help maintain device accuracy over time and temperature. The encoder circuit eliminates the effects of pulse-width distortion of the optically transmitted data by generating one pulse for every edge of the converter data to be transmitted. This coding scheme reduces the effects of the non-ideal characteristics of the LED, such as non-linearity and drift over time and temperature.

ISOLATION AND INSULATION SPECIFICATIONS

The performance of the isolation barrier of the ISO130 is specified with three specifications, two of which require high voltage testing. In accordance with UL1577, the barrier integrity of each isolation amplifier is proof-tested by applying an insulation test voltage greater than or equal to

4500Vrms for one second. This is to guarantee the isolation amplifier will survive a 3750V transient voltage. The barrier leakage current test limit is 5 μ A. Pins 1-4 are shorted together and pins 5-8 are shorted together during the test.

This test is followed by the partial discharge isolation voltage test as specified in the German VDE0884. This method requires the measurement of small current pulses (<5pico Colomb) while applying 960Vrms across every ISO130 isolation barrier. This guarantees 600Vrms continuous isolation (V_{ISO}) voltage. No partial discharge may be initiated to pass this test. This criterion confirms transient overvoltage (1.6 x 600Vrms) protection without damage to the ISO130.

This test method represents “state of the art” for nondestructive high voltage reliability testing. It is based on the effects of nonuniform fields that exist in heterogeneous dielectric material during barrier degradation. In the case of void non-uniformities, electric field stress begins to ionize the void region before bridging the entire high voltage barrier. The transient conduction of charge during and after the ionization can be detected externally as a burst of 0.01 to 0.1 μ s current pulses that repeat on each AC voltage cycle. The minimum AC barrier voltage that initiates partial discharge is defined as the “inception voltage”. Decreasing the barrier voltage to a lower level is required before partial discharge ceases and is defined as the “extinction voltage”.

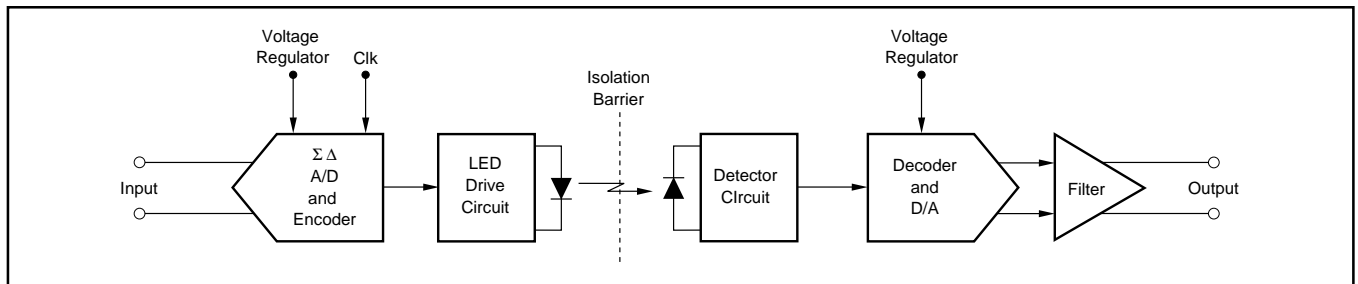

FIGURE 1. Block Diagram of ISO130 Isolation Amplifier.

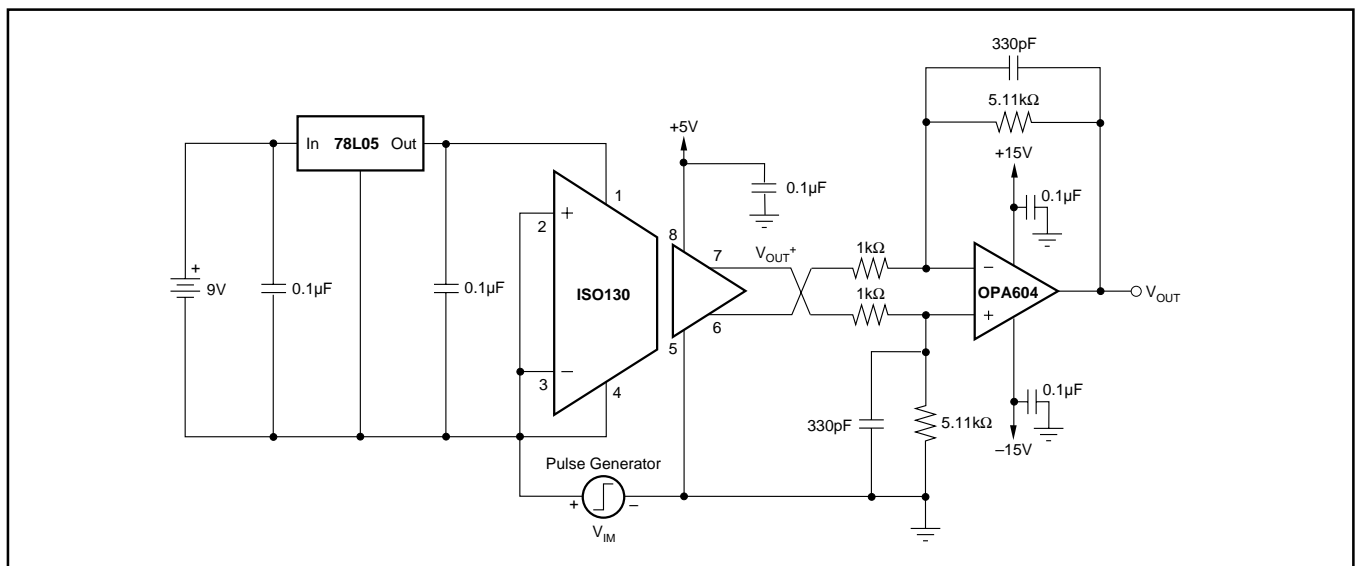

FIGURE 2. Isolation Mode Rejection and Transient Immunity Test Circuit.

Both tests are 100% production tests. The partial discharge testing of the ISO130 is performed after the UL1577 test criterion giving more confidence in the barrier reliability.

The third guaranteed isolation specification for the ISO130 is Transient Immunity (TI), which specifies the minimum rate of rise or fall of an isolation mode noise signal at which small output perturbations begin to occur. An isolation mode signal is defined as a signal appearing between the isolated grounds, GND_1 and GND_2 . Isolation Mode Voltage (IMV) is the voltage appearing between isolated grounds. Under certain circumstances this voltage across the isolation barrier can induce errors at the output of the isolation amplifier. Figure 2 shows the Transient Immunity Test Circuit for the ISO130. In this test circuit a pulse generator is placed between the isolated grounds (GND_1 and GND_2). The inputs of the ISO130 are both tied to GND_1 . A difference amplifier is used

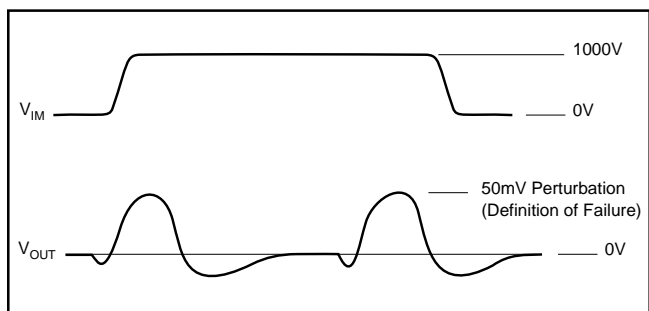

FIGURE 3. Typical Transient Immunity Failure Waveform.

to gain the output signal of the ISO130. A Transient Immunity failure is determined when the output of the ISO130 changes by more than 50mV as illustrated in Figure 3.

Finally, Isolation Mode Rejection Ratio (typically >140dB for the ISO130) is defined as the ratio of differential signal gain to the isolation mode gain at 60Hz. The magnitude of the 60Hz voltage across the isolation barrier during this test is not so large as to cause Transient Immunity errors. The Isolation Mode Rejection Ratio should not be confused with the Common Mode Rejection Ratio. The Common Mode Rejection Ratio defines the relationship of differential signal gain (signal applied differentially between pins 2 and 3) to the common mode gain (input pins tied together and the signal applied to both inputs at the same time).

APPLICATIONS INFORMATION

APPLICATION CIRCUITS

Figure 4 illustrates a typical application for the ISO130. In this motor control circuit, the current that is sent to the motor is sensed by the resistor, R_{SENSE} . The voltage drop across this resistor is gained up by the ISO130 and then transmitted across the isolation barrier. A difference amplifier, A_2 , is used to change the differential output signal of the ISO130 to a single ended signal. This voltage information is then sent to the control circuitry of the motor. The ISO130 is particularly well suited for this application because of its superior Transient Immunity (10kV/ μ s, max) and its excellent immunity to RF noise.

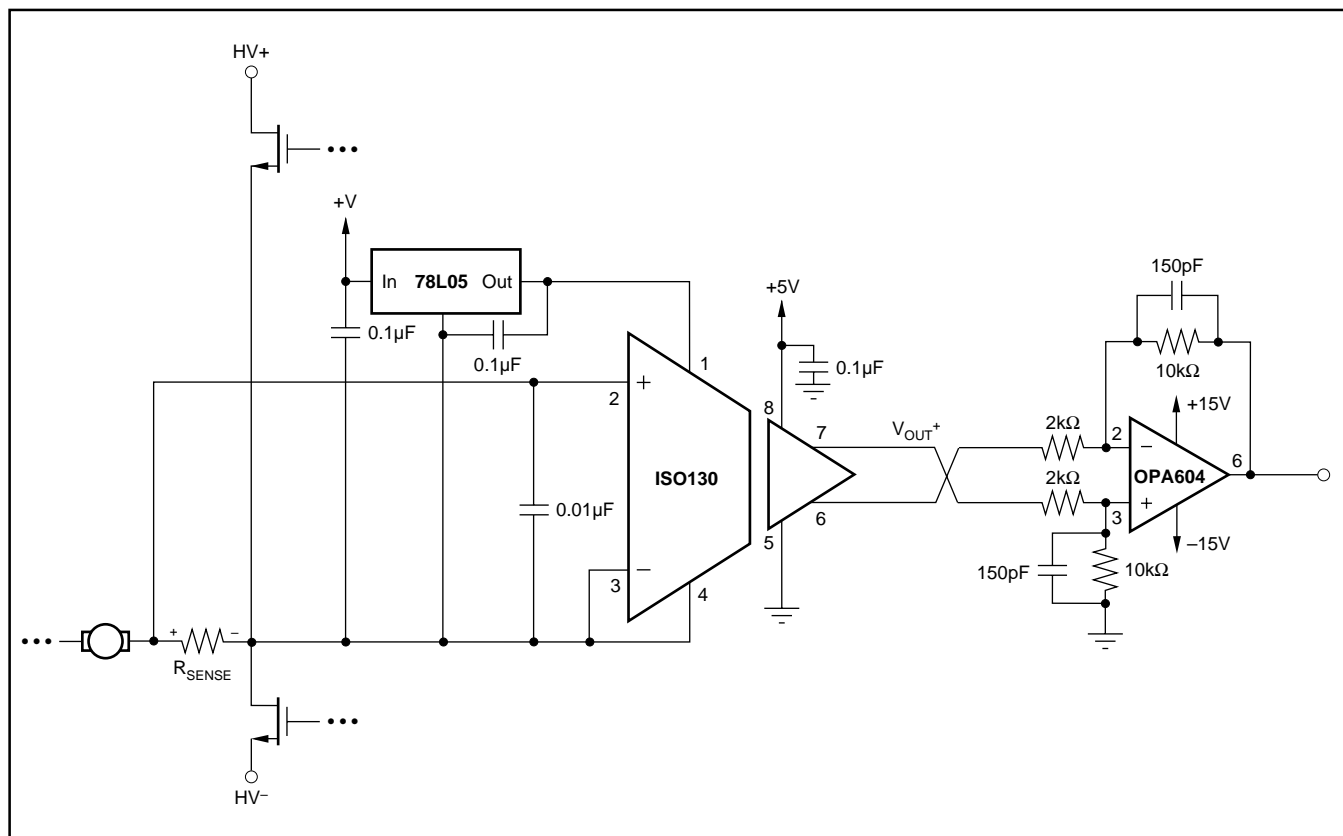

FIGURE 4. ISO130 Used to Monitor Motor Current.

The current-sensing resistor should have a relatively low value of resistance (to minimize power dissipation), a fairly low inductance (to accurately reflect high-frequency signal components), and a reasonably tight tolerance (to maintain overall circuit accuracy).

LAYOUT SUGGESTIONS

1. Bypass capacitors should be located as close as possible to the input and output power supply pins.
2. In some applications, offset voltage can be reduced by placing a $0.01\mu\text{F}$ capacitor from pin 2 and/or pin 3 to GND_1 . This noise can be caused by the combination of long input leads and the switched-capacitor nature of the input circuit. This capacitor(s) should be placed as close to the isolation amplifier as possible.
3. The trace lengths at input should be kept short or a twisted wire pair should be used to minimize EMI and inductance effects. For optimum performance, the input signal should be as close to the input pins as possible.
4. A maximum distance between the input and output sides of the isolation amplifier should be maintained in the layout in order to minimize stray capacitance. This practice will help obtain optimal Isolation Mode performance. Ground planes should not pass below the device on the PCB.
5. Care should be taken in selecting isolated power supplies or regulators. The ISO130 can be affected by changes in the power supply voltages. Carefully regulated power supplies are recommended.
6. For improved nonlinearity and nonlinearity temperature drift performance, pin 3 should be tied to GND_1 and the input voltage range of pin 2 should be less than 100mV.

PACKAGE DRAWINGS

Package Number 006-2 - 8-Pin Plastic, Single-Wide DIP With Gull Wing Leads

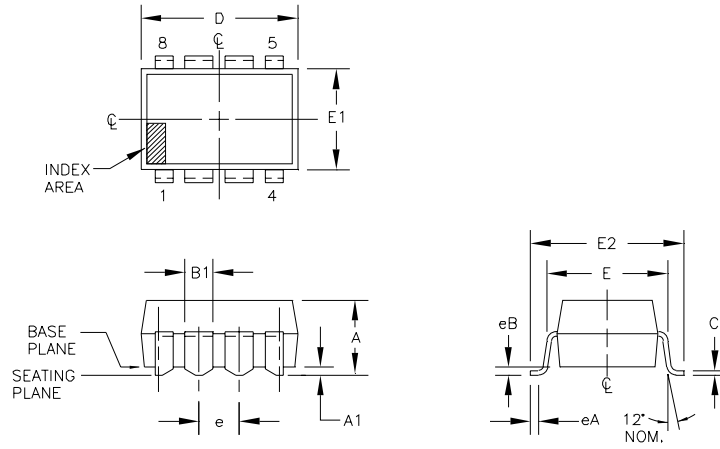

DIM	INCHES		MILLIMETERS		NOTE
	MIN.	MAX.	MIN.	MAX.	
A	--	.185	--	4.70	
A1	.020	--	0.51	--	
B1	--	.070	--	1.78	
C	.007	.013	0.18	0.33	
D	.370	.390	9.40	9.91	
E	.290	.310	7.37	7.87	
E1	.240	.260	6.10	6.60	
E2	.370	.390	9.40	9.91	
e	.090	.110	2.29	2.79	
eA	.015	.035	0.38	0.89	
eB	.015	.025	0.38	0.64	
N	8		8		

NOTES:

1. CONTROLLING DIMENSION: INCH. IN CASE OF CONFLICT BETWEEN THE ENGLISH AND METRIC DIMENSIONS, THE INCH DIMENSIONS CONTROL.
2. DIMENSIONING AND TOLERANCING PER ANSI Y14.5M-1982.
3. D AND E1 DIMENSIONS FOR PLASTIC PACKAGES DO NOT INCLUDE MOLD FLASH OR PROTRUSIONS. MOLD FLASH OR PROTRUSIONS SHALL NOT EXCEED .010 INCH (0.25mm).
4. N IS THE MAXIMUM NUMBER OF TERMINAL POSITIONS.

5. FOR AUTOMATIC INSERTION, ANY RAISED IRREGULARITY ON THE TOP SURFACE (STEP, MESA, ETC.) SHALL BE SYMMETRICAL ABOUT THE LATERAL AND LONGITUDINAL PACKAGE CENTERLINES.

PACKAGE NUMBER: ZZ006-2 REV.: B
JEDEC NUMBER: NONE

Package Number 006-3 - 8-Pin Plastic, Single-Wide DIP

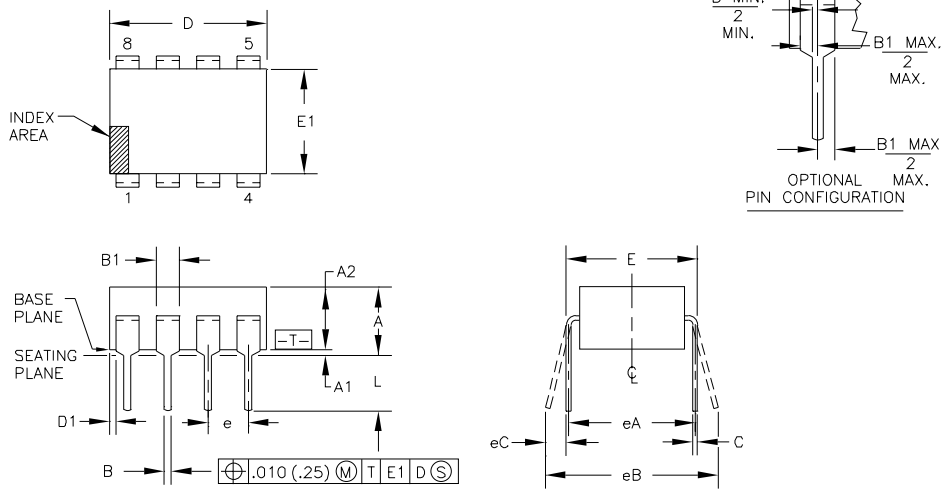

DIM	INCHES		MILLIMETERS		NOTE
	MIN.	MAX.	MIN.	MAX.	
A	--	.210	--	5.33	3
A1	.015	--	0.38	--	3
A2	.115	.195	2.92	4.95	
B	.014	.025	0.36	.635	
B1	.045	.070	1.14	1.78	
C	.008	.015	0.20	0.38	
D	.348	.430	8.84	10.92	4
D1	.005	--	0.13	--	
E	.300	.325	7.62	8.26	5
E1	.240	.280	6.10	7.11	4
e	.100 BASIC		2.54 BASIC		
eA	.300 BASIC		7.63 BASIC		5
eB	--	.430	--	10.92	6
L	.115	.160	2.92	4.06	3

NOTES:

1. CONTROLLING DIMENSION: INCH. IN CASE OF CONFLICT BETWEEN THE ENGLISH AND METRIC DIMENSIONS, THE INCH DIMENSIONS CONTROL.
2. DIMENSIONING AND TOLERANCING PER ANSI Y14.5M-1982.
3. DIMENSIONS A, A1, AND L ARE MEASURED WITH THE PACKAGE SEATED IN JEDEC SEATING PLANE GAUGE GS-3.
4. D AND E1 DIMENSIONS FOR PLASTIC PACKAGES DO NOT INCLUDE MOLD FLASH OR PROTRUSIONS. MOLD FLASH OR PROTRUSIONS SHALL NOT EXCEED .010 INCH (0.25mm).
5. E AND eA MEASURED WITH THE LEADS CONSTRAINED TO BE PERPENDICULAR TO PLANE T.

6. eB AND eC ARE MEASURED AT THE LEAD TIPS WITH THE LEADS UNCONSTRAINED. eC MUST BE ZERO OR GREATER.

7. N IS THE MAXIMUM NUMBER OF TERMINAL POSITIONS.

8. CORNER LEADS (1, 4, 5, AND 8) MAY BE CONFIGURED AS SHOWN IN THE OPTIONAL PIN CONFIGURATION.

9. FOR AUTOMATIC INSERTION, ANY RAISED IRREGULARITY ON THE TOP SURFACE (STEP, MESA, ETC.) SHALL BE SYMMETRICAL ABOUT THE LATERAL AND LONGITUDINAL PACKAGE CENTERLINES.

PACKAGE NUMBER: ZZ006-3 REV.: B
JEDEC NUMBER: MS-001 WITH THE EXCEPTION OF DIM. B

IMPORTANT NOTICE

Texas Instruments Incorporated and its subsidiaries (TI) reserve the right to make corrections, modifications, enhancements, improvements, and other changes to its products and services at any time and to discontinue any product or service without notice. Customers should obtain the latest relevant information before placing orders and should verify that such information is current and complete. All products are sold subject to TI's terms and conditions of sale supplied at the time of order acknowledgment.

TI warrants performance of its hardware products to the specifications applicable at the time of sale in accordance with TI's standard warranty. Testing and other quality control techniques are used to the extent TI deems necessary to support this warranty. Except where mandated by government requirements, testing of all parameters of each product is not necessarily performed.

TI assumes no liability for applications assistance or customer product design. Customers are responsible for their products and applications using TI components. To minimize the risks associated with customer products and applications, customers should provide adequate design and operating safeguards.

TI does not warrant or represent that any license, either express or implied, is granted under any TI patent right, copyright, mask work right, or other TI intellectual property right relating to any combination, machine, or process in which TI products or services are used. Information published by TI regarding third-party products or services does not constitute a license from TI to use such products or services or a warranty or endorsement thereof. Use of such information may require a license from a third party under the patents or other intellectual property of the third party, or a license from TI under the patents or other intellectual property of TI.

Reproduction of TI information in TI data books or data sheets is permissible only if reproduction is without alteration and is accompanied by all associated warranties, conditions, limitations, and notices. Reproduction of this information with alteration is an unfair and deceptive business practice. TI is not responsible or liable for such altered documentation. Information of third parties may be subject to additional restrictions.

Resale of TI products or services with statements different from or beyond the parameters stated by TI for that product or service voids all express and any implied warranties for the associated TI product or service and is an unfair and deceptive business practice. TI is not responsible or liable for any such statements.

TI products are not authorized for use in safety-critical applications (such as life support) where a failure of the TI product would reasonably be expected to cause severe personal injury or death, unless officers of the parties have executed an agreement specifically governing such use. Buyers represent that they have all necessary expertise in the safety and regulatory ramifications of their applications, and acknowledge and agree that they are solely responsible for all legal, regulatory and safety-related requirements concerning their products and any use of TI products in such safety-critical applications, notwithstanding any applications-related information or support that may be provided by TI. Further, Buyers must fully indemnify TI and its representatives against any damages arising out of the use of TI products in such safety-critical applications.

TI products are neither designed nor intended for use in military/aerospace applications or environments unless the TI products are specifically designated by TI as military-grade or "enhanced plastic." Only products designated by TI as military-grade meet military specifications. Buyers acknowledge and agree that any such use of TI products which TI has not designated as military-grade is solely at the Buyer's risk, and that they are solely responsible for compliance with all legal and regulatory requirements in connection with such use.

TI products are neither designed nor intended for use in automotive applications or environments unless the specific TI products are designated by TI as compliant with ISO/TS 16949 requirements. Buyers acknowledge and agree that, if they use any non-designated products in automotive applications, TI will not be responsible for any failure to meet such requirements.

Following are URLs where you can obtain information on other Texas Instruments products and application solutions:

Products

Amplifiers	amplifier.ti.com
Data Converters	dataconverter.ti.com
DSP	dsp.ti.com
Clocks and Timers	www.ti.com/clocks
Interface	interface.ti.com
Logic	logic.ti.com
Power Mgmt	power.ti.com
Microcontrollers	microcontroller.ti.com
RFID	www.ti-rfid.com
RF/IF and ZigBee® Solutions	www.ti.com/lprf

Applications

Audio	www.ti.com/audio
Automotive	www.ti.com/automotive
Broadband	www.ti.com/broadband
Digital Control	www.ti.com/digitalcontrol
Medical	www.ti.com/medical
Military	www.ti.com/military
Optical Networking	www.ti.com/opticalnetwork
Security	www.ti.com/security
Telephony	www.ti.com/telephony
Video & Imaging	www.ti.com/video
Wireless	www.ti.com/wireless

Mailing Address: Texas Instruments, Post Office Box 655303, Dallas, Texas 75265
Copyright © 2008, Texas Instruments Incorporated