

LOW DROPOUT VOLTAGE REGULATOR

The KA378R05 is a low-dropout voltage regulator suitable for various electronic equipments. It provide constant voltage power source with TO-220 4 lead full mold package. Dropout voltage of KA378R05 is below 0.5v in full rated current(3A). This regulator has various function such as peak current protection, thermal shut down, overvoltage protection and output disable function.

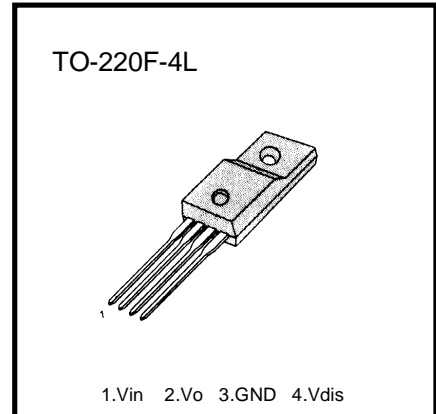

FEATURES

- 3A / 5V Output low dropout voltage regulator
- TO220 Full-Mold package (4PIN)
- Overcurrent protection, Thermal shutdown
- Overvoltage protection, Shortcircuit protection
- With output disable function

ORDERING INFORMATION

Device	Package	Operating Temperature
KA378R05	TO-220F-4L	-20°C ~ +80°C

BLOCK DIAGRAM

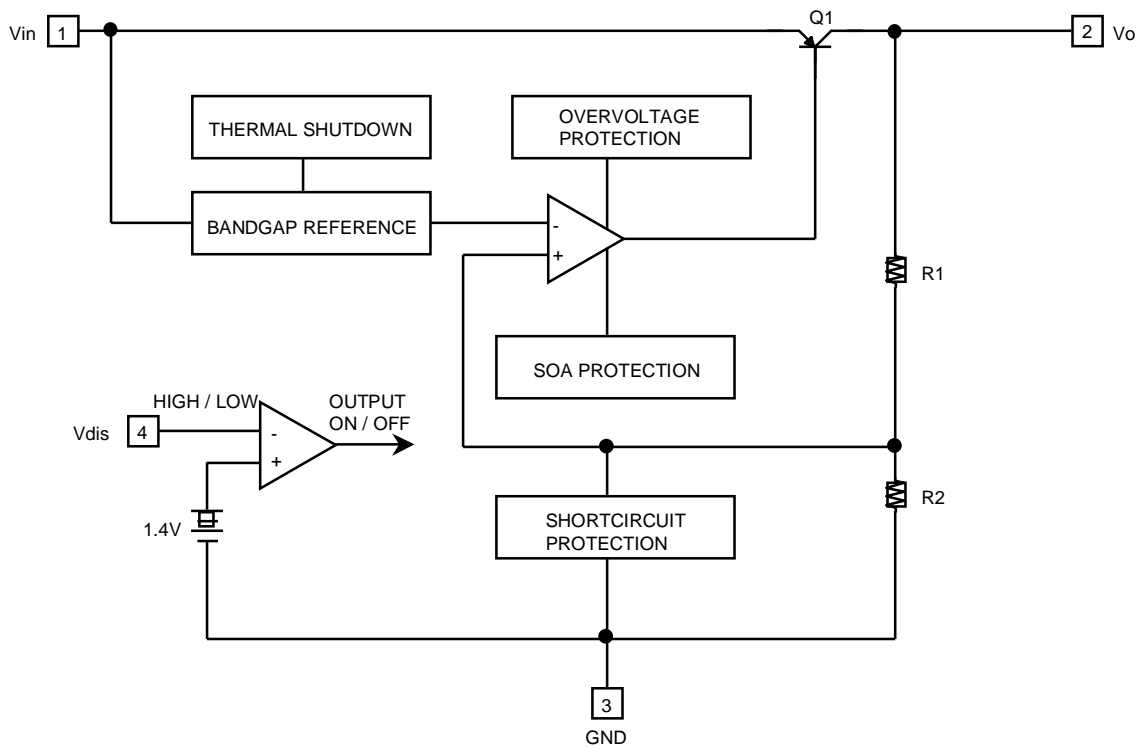

ABSOLUTE MAXIMUM RATINGS

Characteristic	Symbol	Value	Unit	Remark
Input Voltage	Vin	35	V	-
Disable Voltage	Vdis	35	V	-
Output Current	Io	3.0	A	-
Power Dissipation 1	Pd1	1.5	W	No Heatsink
Power Dissipation 2	Pd2	15	W	With Heatsink
Junction Temperature	Tj	150	°C	-
Operating Temperature	Topr	-20 ~ 80	°C	-

ELECTRICAL CHARACTERISTICS

(Vin=7V, Io=1.5A, Ta=25°C, unless otherwise specified)

Characteristic	Symbol	Test Condition	Min	Typ	Max	Unit
Output Voltage	Vo	-	4.88	5	5.12	V
Load Regulation	Rload	5mA < Io < 3A	-	0.1	2.0	%
Line Regulation	Rline	6V < Vin < 12V	-	0.5	2.5	%
Ripple Rejection Ratio	RR	note1	45	55	-	dB
Dropout Voltage	Vdrop	Io = 3A	-	-	0.5	V
Disable Voltage High	VdisH	Output Active	2.0	-	-	V
Disable Voltage Low	VdisL	Output Disabled	-	-	0.8	V
Disable Bias Current High	IdisH	Vdis = 2.7V	-	-	20	μA
Disable Bias Current Low	IdisL	Vdis = 0.4V	-	-	-0.4	mA
Quiescent Current	Iq	Io = 0A	-	-	10	mA

*note1 : These parameters, although guaranteed, are not 100% tested in production.

FIG.1 Output Voltage vs. Input Voltage

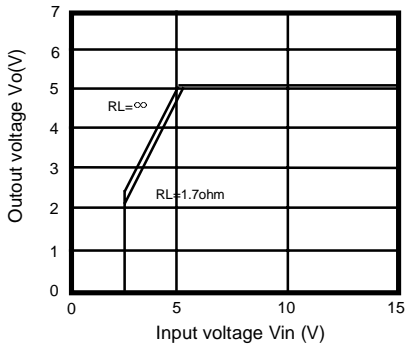

FIG.2 Quiescent Current vs. Input Voltage

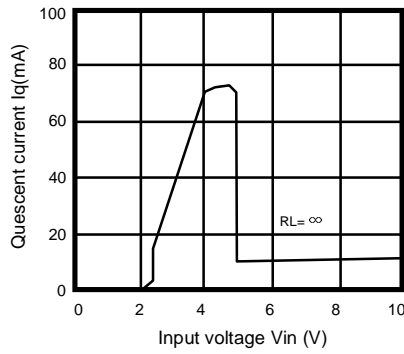

FIG.3 OUTPUT VOLTAGE vs. DISABLE VOLTAGE

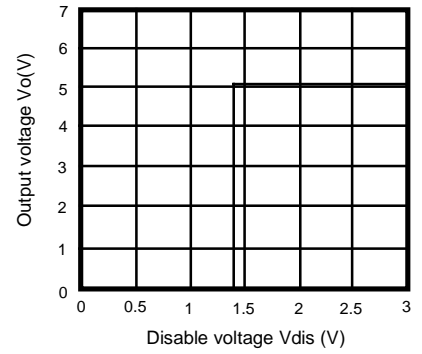

FIG.4 Output Voltage vs. Temperature(Tj)

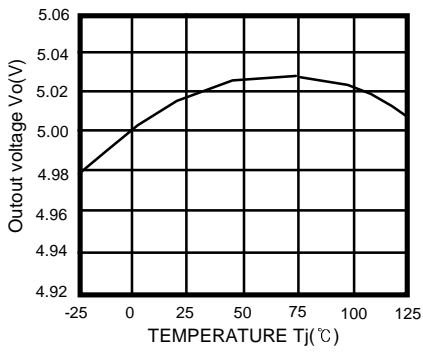

FIG.5 Quiescent Current vs. Temperature(Tj)

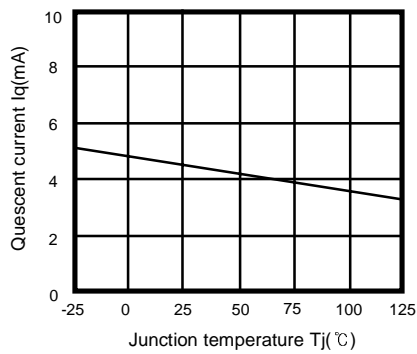

FIG.6 Dropout Voltage vs. Junction Temperature

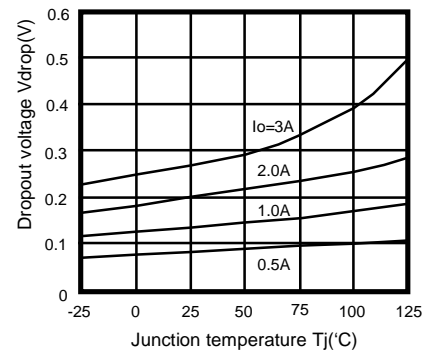
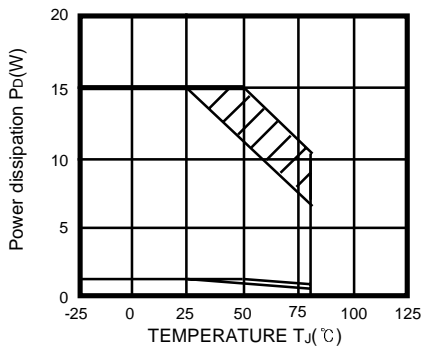
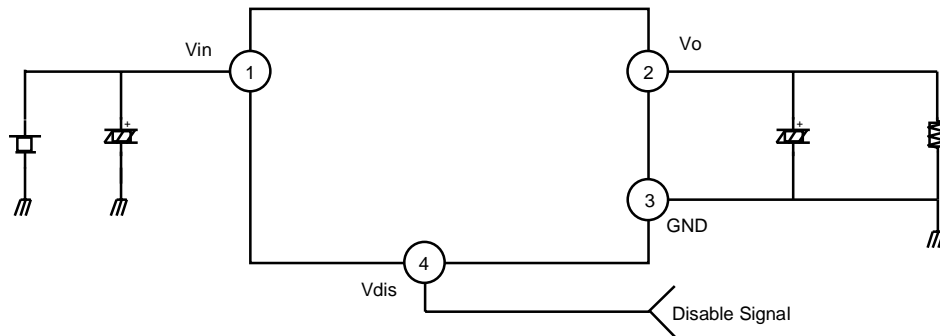

FIG.7 POWER DISSIPATION vs. TEMPERATURE(Ta)



TYPICAL APPLICATION

FIG.1 APPLICATION CIRCUIT



- * C_i is required if regulator is located an appreciable distance from power supply filter.
- * C_o improves stability and transient response. ($C_o > 47\mu\text{F}$)

< TO220F-4L >

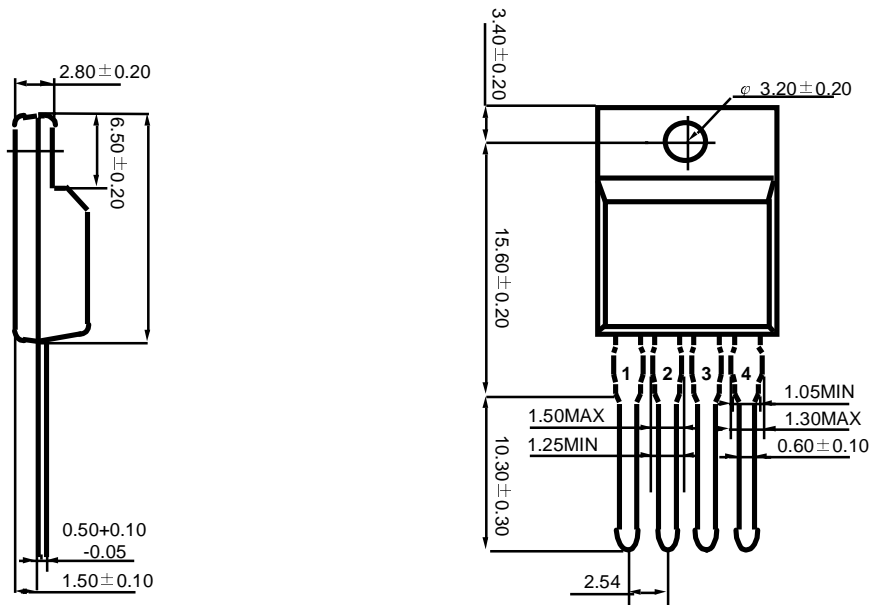

* DIMENSIONS IN MILIMETER