

KA5x0165Rxx-SERIES

KA5H0165R/RN, KA5M0165R/RN/RI, KA5L0165R/RN/RI

KA5H0165RV/RVN, KA5M0165RV/RVN, KA5L0165RV/RVN

Fairchild Power Switch(SPS)

Features

- Precision fixed operating frequency (100 / 67 / 50KHz)
- Pulse by pulse current limiting
- Over current protection
- Over voltage protection (Min. 25V) -KA5x0165R/RN/RI
- Internal thermal shutdown function
- Under voltage lockout
- Internal high voltage sense FET
- Auto-restart mode

Description

The SPS product family is specially designed for an off-line SMPS with minimal external components. The SPS consist of high voltage power SenseFET and current mode PWM IC. Included PWM controller features integrated fixed oscillator, under voltage lock out, leading edge blanking, optimized gate turn-on/turn-off driver, thermal shut down protection, over voltage protection, and temperature compensated precision current sources for loop compensation and fault protection circuitry. Compared to discrete MOSFET and controller or RCC switching converter solution, a SPS can reduce total component count, design size, weight and at the same time increase efficiency, productivity, and system reliability. It has a basic platform well suited for cost-effective design in either a flyback converter or a forward converter.

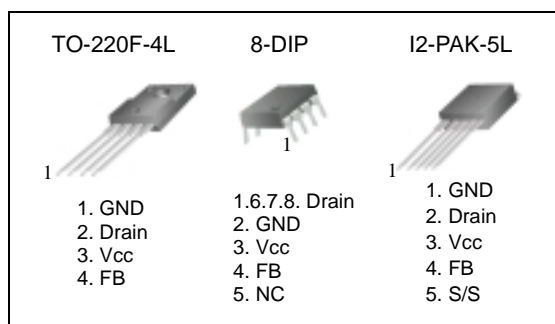

Internal Block Diagram

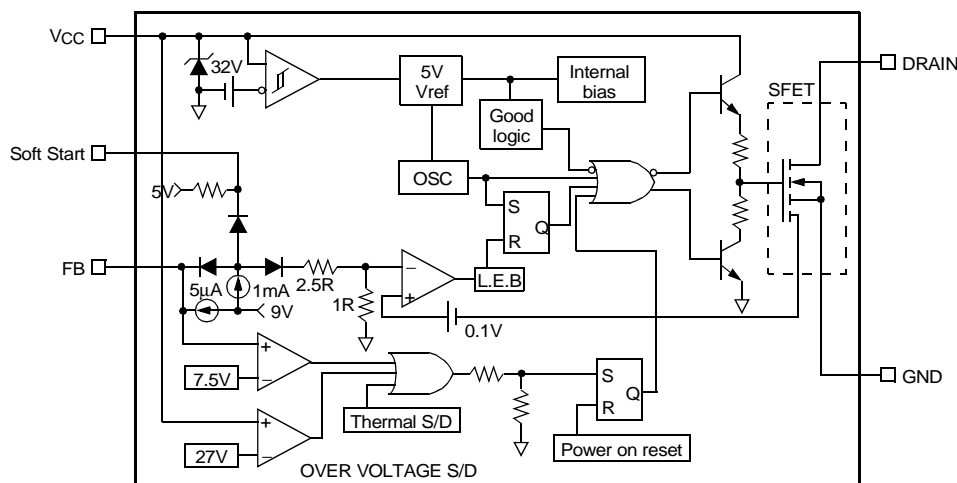

Absolute Maximum Ratings

($T_a=25^\circ\text{C}$, unless otherwise specified)

Characteristic	Symbol	Value	Unit
Maximum Drain Voltage	$V_{D,MAX}$	650	V
Drain-Gate Voltage ($R_{GS}=1\text{M}\Omega$)	V_{DGR}	650	V
Gate-Source (GND) Voltage	V_{GS}	± 30	V
Drain Current Pulsed ⁽¹⁾	I_{DM}	4.0	ADC
Continuous Drain Current ($T_C=25^\circ\text{C}$)	I_D	1.0	ADC
Continuous Drain Current ($T_C=100^\circ\text{C}$)	I_D	0.7	ADC
Single Pulsed Avalanche Energy ⁽²⁾	E_{AS}	95	mJ
Maximum Supply Voltage	$V_{CC,MAX}$	30	V
Analog Input Voltage Range	V_{FB}	-0.3 to V_{SD}	V
Total Power Dissipation	P_D	40	W
	Derating	0.32	W/ $^\circ\text{C}$
Operating Junction Temperature.	T_J	+160	$^\circ\text{C}$
Operating Ambient Temperature.	T_A	-25 to +85	$^\circ\text{C}$
Storage Temperature Range.	T_{STG}	-55 to +150	$^\circ\text{C}$

Notes:

1. Repetitive rating: Pulse width limited by maximum junction temperature
2. $L=24\text{mH}$, starting $T_J=25^\circ\text{C}$

Electrical Characteristics (SFET part)

(Ta=25°C unless otherwise specified)

Parameter	Symbol	Condition	Min.	Typ.	Max.	Unit
Drain-source breakdown voltage	BVDSS	VGS=0V, ID=50μA	650	-	-	V
Zero gate voltage drain current	IDSS	VDS=Max. Rating, VGS=0V	-	-	50	μA
		VDS=0.8Max. Rating, VGS=0V, TC=125°C	-	-	200	μA
Static drain-source on resistance ^(note)	RDS(ON)	VGS=10V, ID=0.5A	-	8	10	Ω
Forward transconductance ^(note)	gfs	VDS=50V, ID=0.5A	0.5	-	-	S
Input capacitance	Ciss	VGS=0V, VDS=25V, f=1MHz	-	250	-	pF
Output capacitance	Coss		-	25	-	
Reverse transfer capacitance	Crss		-	10	-	
Turn on delay time	td(on)	VDD=0.5BVDSS, ID=1.0A (MOSFET switching time are essentially independent of operating temperature)	-	12	-	nS
Rise time	tr		-	4	-	
Turn off delay time	td(off)		-	30	-	
Fall time	tf		-	10	-	
Total gate charge (gate-source+gate-drain)	Qg	VGS=10V, ID=1.0A, VDS=0.5BVDSS (MOSFET switching time are essentially independent of operating temperature)	-	-	21	nC
Gate-source charge	Qgs		-	3	-	
Gate-drain (Miller) charge	Qgd		-	9	-	

Note:

Pulse test: Pulse width ≤ 300μS, duty cycle ≤ 2%

$$S = \frac{1}{R}$$

Electrical Characteristics (CONTROL part)

(Ta=25°C unless otherwise specified)

Parameter	Symbol	Condition	Min.	Typ.	Max.	Unit
UVLO SECTION						
Start Threshold Voltage	VSTART	VFB=GND	14	15	16	V
Stop Threshold Voltage	VSTOP	VFB=GND	8.4	9	9.6	V
OSCILLATOR SECTION						
Initial accuracy	FOSC	KA5H0165Rxx	90	100	110	kHz
Initial accuracy	FOSC	KA5M0165Rxx	61	67	73	kHz
Initial accuracy	FOSC	KA5L0165Rxx	45	50	55	kHz
Frequency change with temperature ⁽²⁾	$\Delta F/\Delta T$	-25°C≤Ta≤+85°C	-	±5	±10	%
Maximum duty cycle	Dmax	KA5H0165Rxx	62	67	72	%
Maximum duty cycle	Dmax	KA5M0165Rxx KA5L0165Rxx	72	77	82	%
FEEDBACK SECTION						
Feedback source current	IFB	Ta=25°C, 0V≤Vfb≤3V	0.7	0.9	1.1	mA
Shutdown feedback voltage	VSD	Vfb≥6.5V	6.9	7.5	8.1	V
Shutdown delay current	I _{delay}	Ta=25°C, 3V≤Vfb≤VSD	4	5	6	μA
SOFT START SECTION						
Soft Start Voltage	VSS	KA5x0165RI	4.7	5.0	5.3	V
Soft Start Current	I _{SS}		0.8	1.0	1.2	mA
REFERENCE SECTION						
Output voltage ⁽¹⁾	V _{ref}	Ta=25°C	4.80	5.00	5.20	V
Temperature Stability ⁽¹⁾⁽²⁾	V _{ref} /ΔT	-25°C≤Ta≤+85°C	-	0.3	0.6	mV/°C
CURRENT LIMIT(SELF-PROTECTION)SECTION						
Peak Current Limit	I _{OVER}	Max. inductor current	0.53	0.6	0.67	A
PROTECTION SECTION						
Thermal shutdown temperature (Tj) ⁽¹⁾	TSD	-	140	160	-	°C
Over voltage protection	V _{OVP}	KA5x0165R/RN/RI	25	27	29	V
TOTAL STANDBY CURRENT SECTION						
Start Up Current	I _{START}	V _{CC} =14V	-	100	170	μA
Operating supply current (control part only)	I _{OP}	V _{CC} ≤28	-	7	12	mA

Notes:

1. These parameters, although guaranteed, are not 100% tested in production
2. These parameters, although guaranteed, are tested in EDS (wafer test) process

Typical Performance Characteristics

(These characteristic graphs are normalized at Ta=25°C)

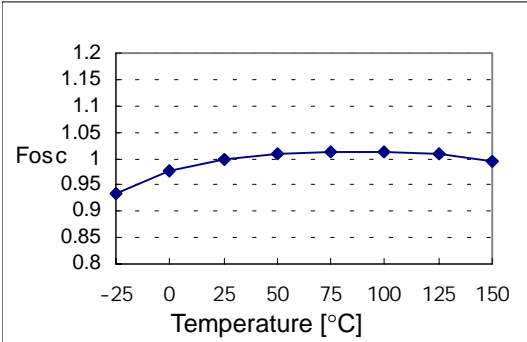

Figure 1. Operating Frequency

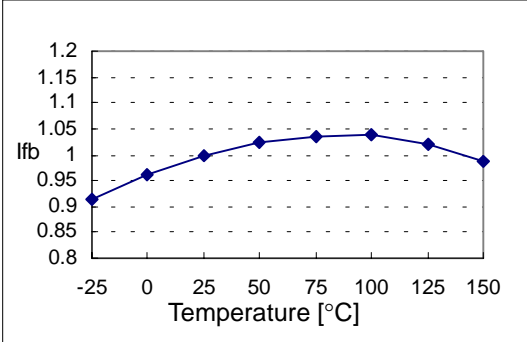

Figure 2. Feedback Source Current

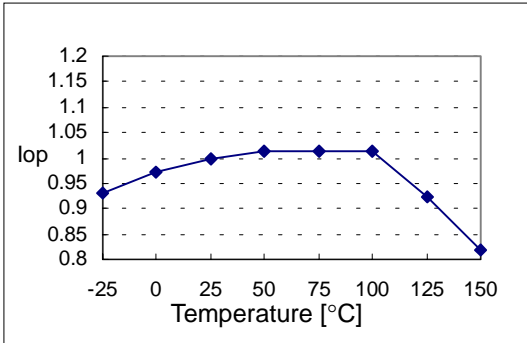

Figure 3. Operating Supply Current

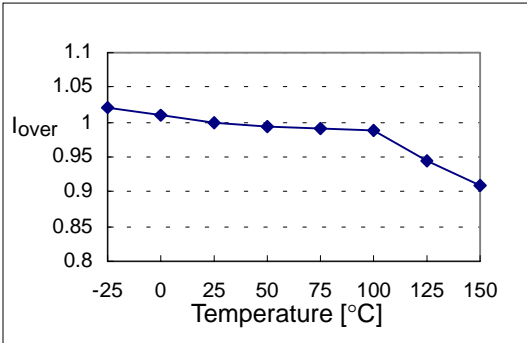

Figure 4. Peak Current Limit

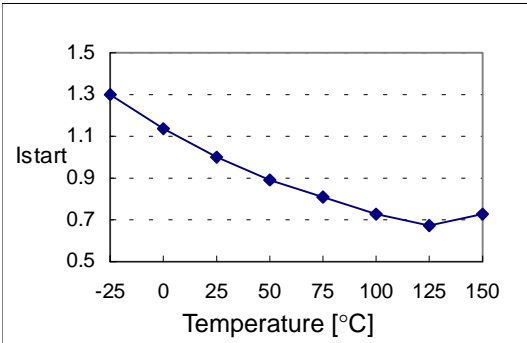

Figure 5. Start up Current

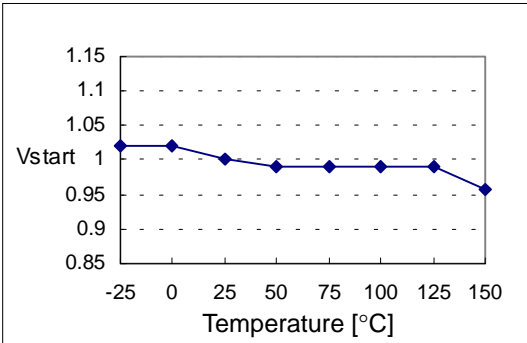

Figure 6. Start Threshold Voltage

Typical Performance Characteristics (Continued)

(These characteristic graphs are normalized at Ta=25°C)

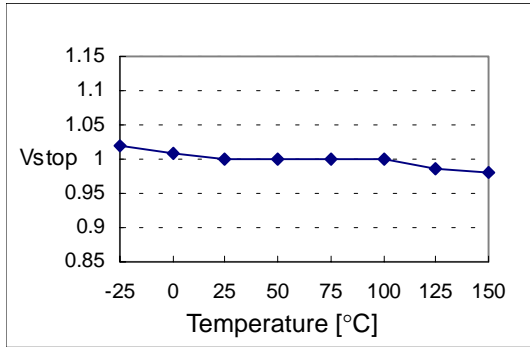

Figure 7. Stop Threshold Voltage

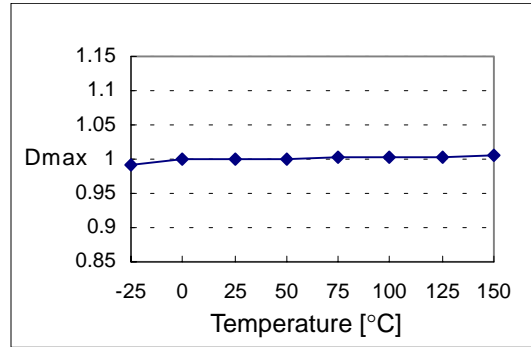

Figure 8. Maximum Duty Cycle

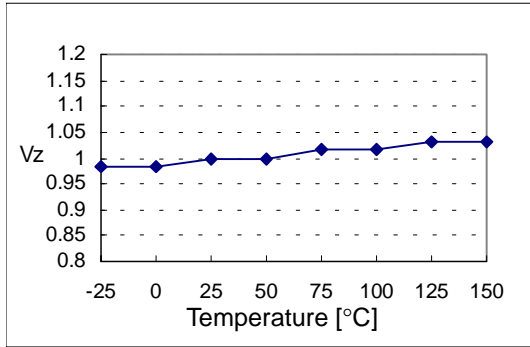

Figure 9. VCC Zener Voltage

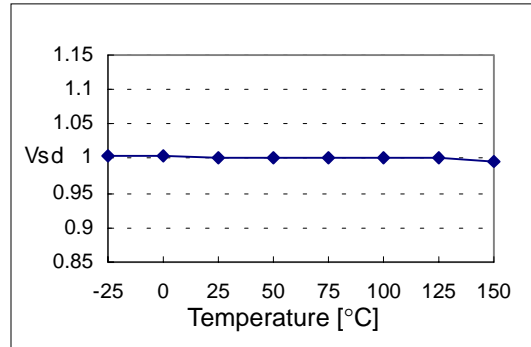

Figure 10. Shutdown Feedback Voltage

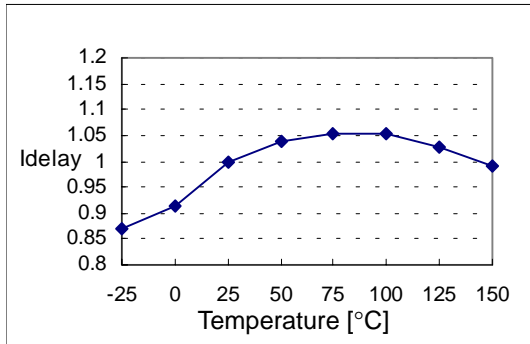

Figure 11. Shutdown Delay Current

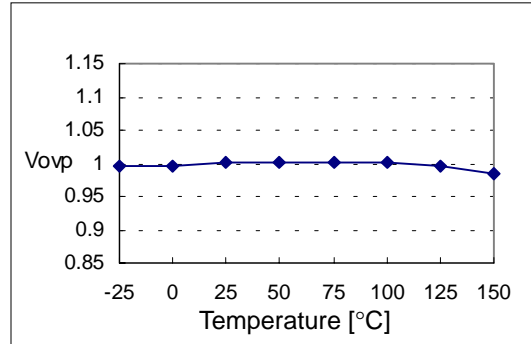

Figure 12. Over Voltage Protection

Typical Performance Characteristics (Continued)

(These characteristic graphs are normalized at Ta=25°C)

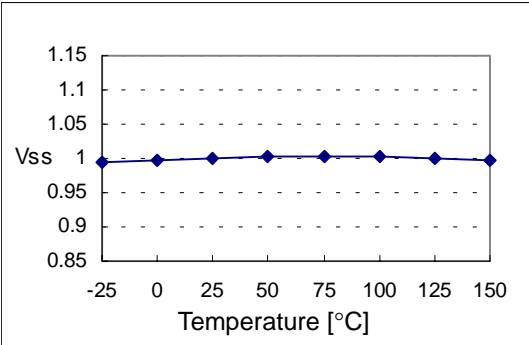

Figure13. Soft Start Voltage

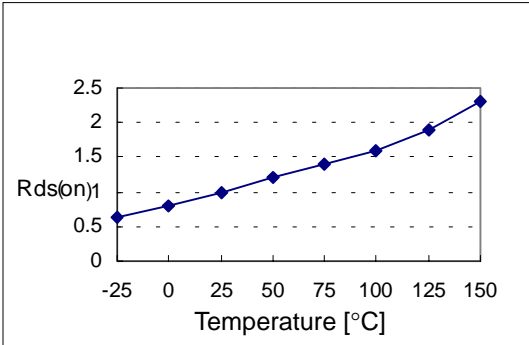
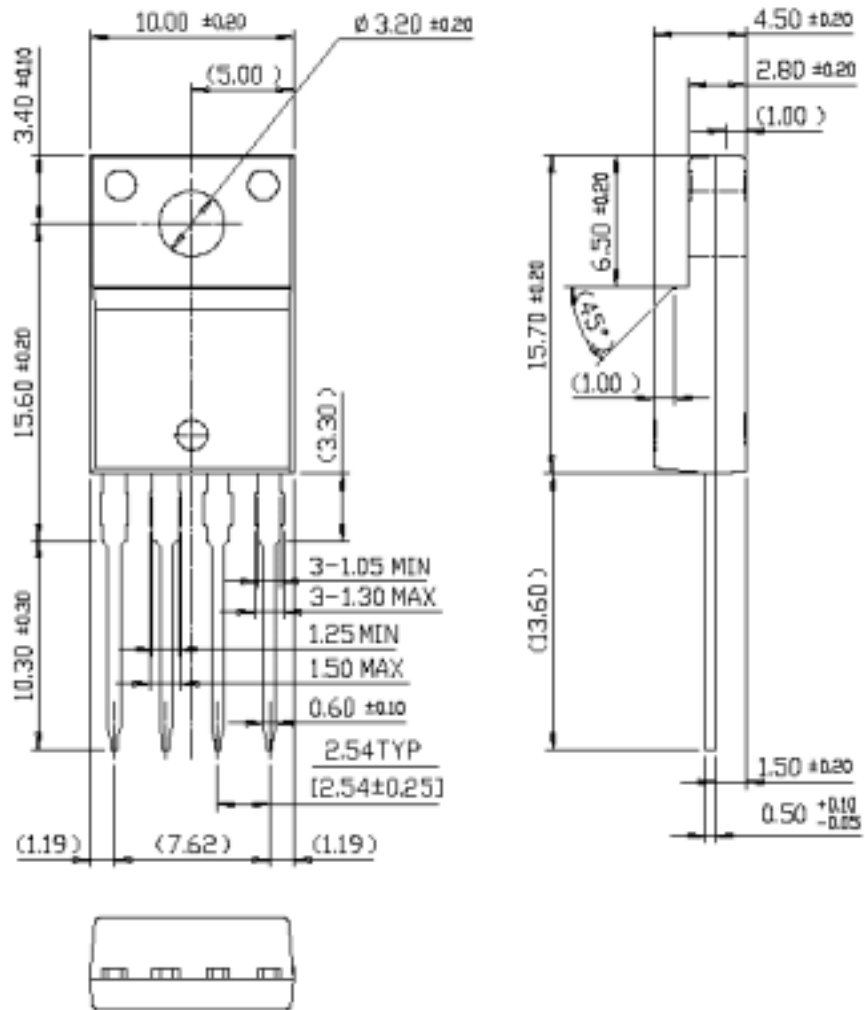

Figure 14. Static Drain-Source on Resistance

Package Dimensions

TO-220F-4L



Package Dimensions (Continued)

TO-220F-4L (Forming)

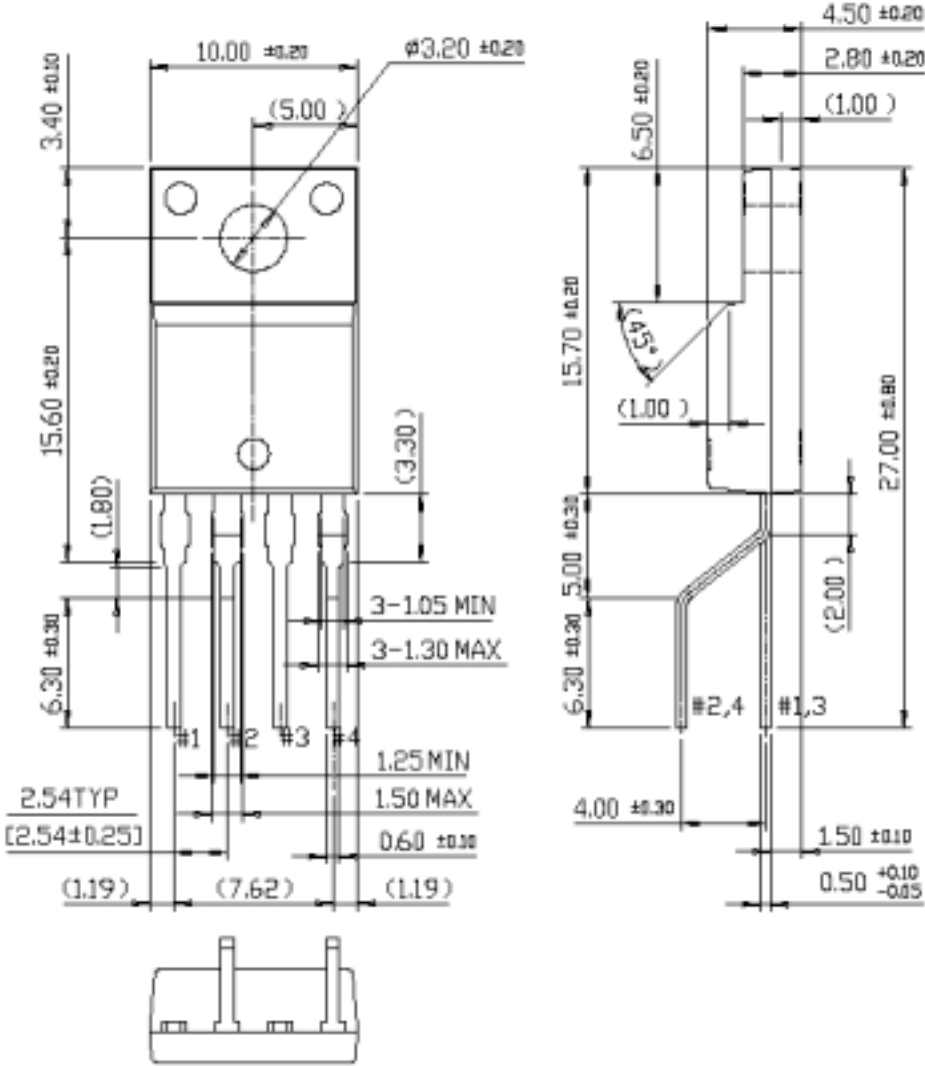

Package Dimensions (Continued)

8-DIP

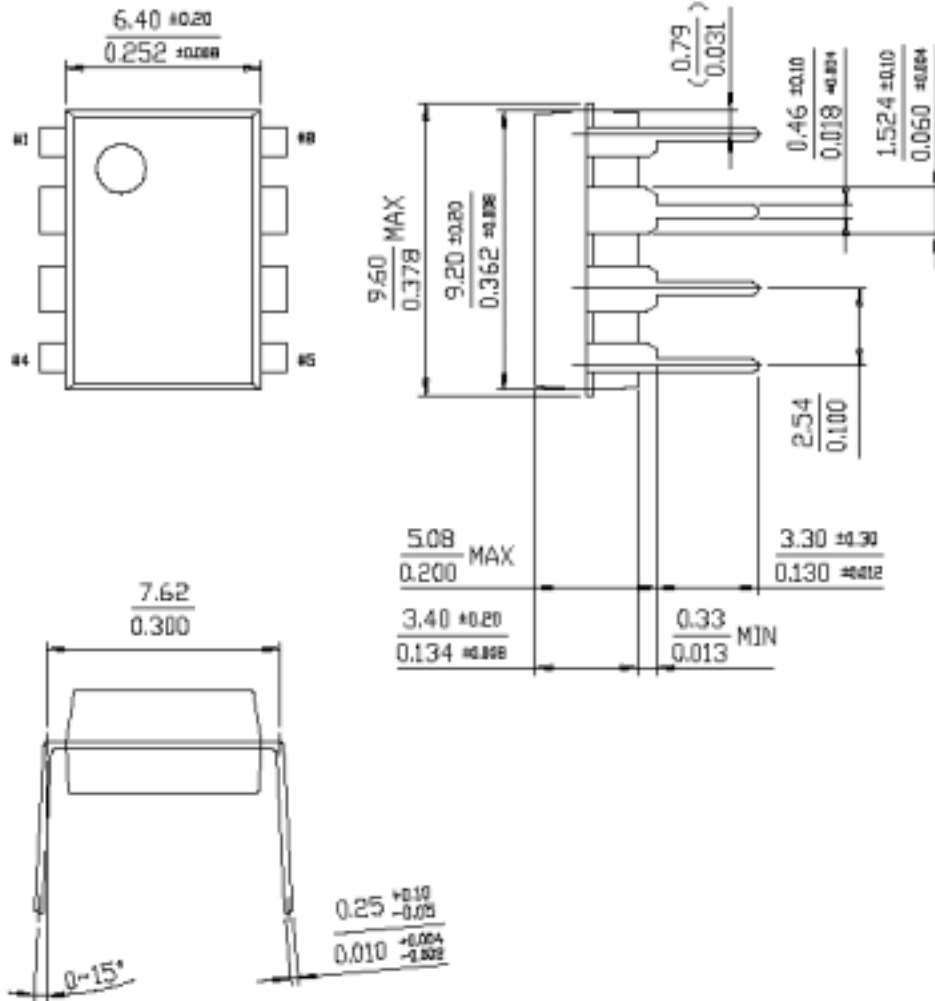

Package Dimensions (Continued)

I2-PAK-5L

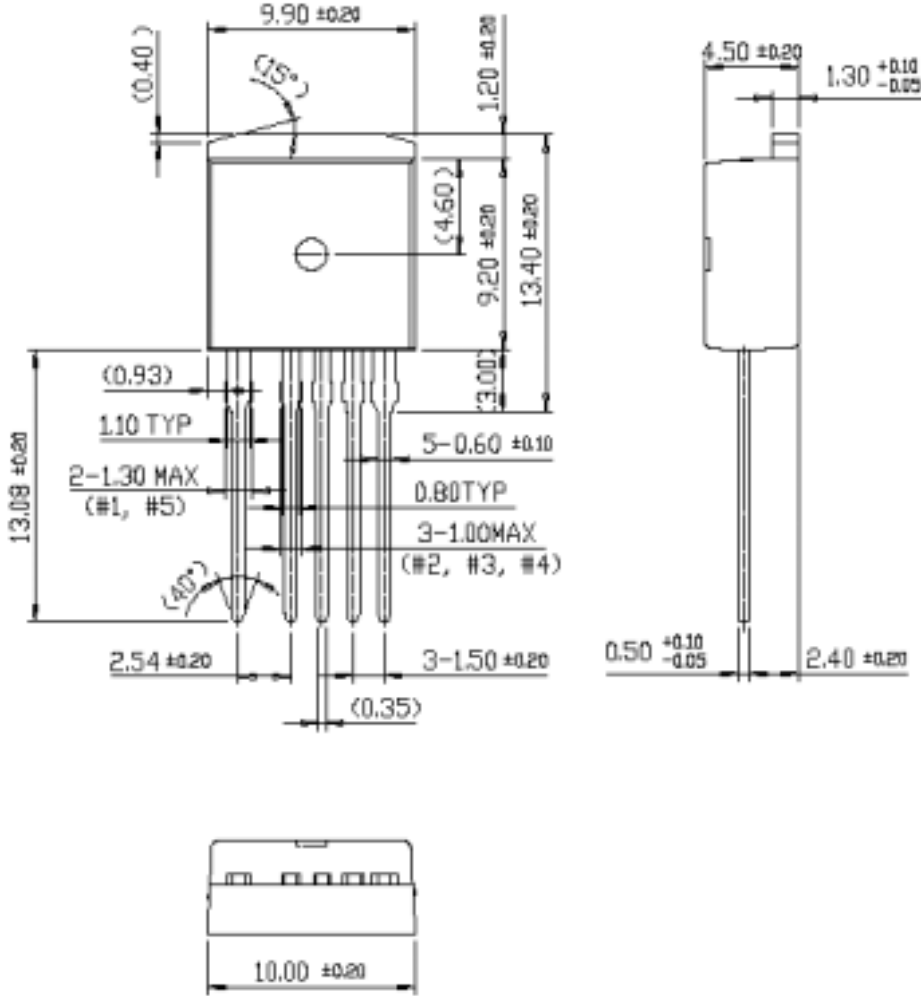

Package Dimensions (Continued)

I2-PAK-5L (Forming)

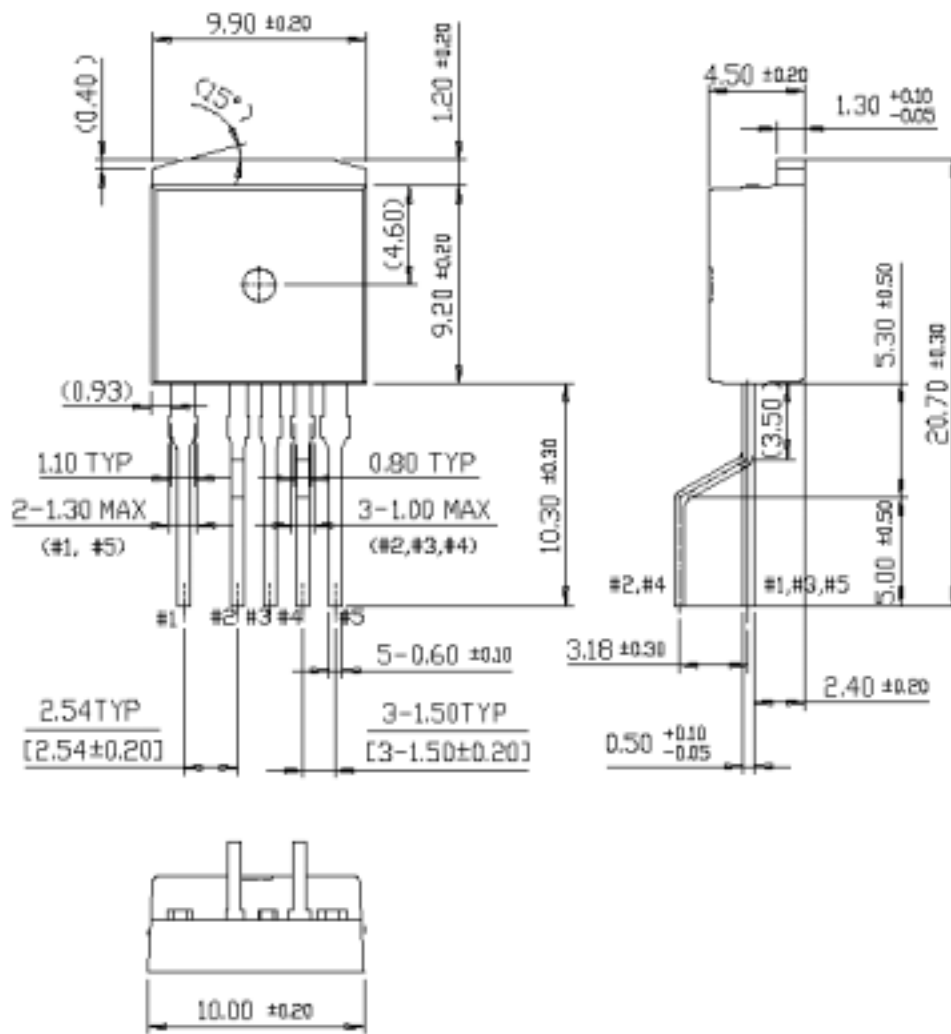

Ordering Information

Product Number	Package	Marking Code	BVDSS	FOSC	RDS(on)
KA5H0165R-TU	TO-220F-4L	5H0165R	650V	100kHz	8Ω
KA5H0165R-YDTU	TO-220F-4L(Forming)				
KA5M0165R-TU	TO-220F-4L	5M0165R	650V	67kHz	8Ω
KA5M0165R-YDTU	TO-220F-4L(Forming)				
KA5L0165R-TU	TO-220F-4L	5L0165R	650V	50kHz	8Ω
KA5L0165R-YDTU	TO-220F-4L(Forming)				
KA5H0165RN	8-DIP	5H0165R	650V	100kHz	8Ω
KA5M0165RN	8-DIP	5M0165R	650V	67kHz	8Ω
KA5L0165RN	8-DIP	5L0165R	650V	50kHz	8Ω
KA5M0165RI-TU	I ² -PAK-5L	5M0165RI	650V	67kHz	8Ω
KA5M0165RI-YDTU	I ² -PAK-5L(Forming)				
KA5L0165RI-TU	I ² -PAK-5L	5L0165RI	650V	50kHz	8Ω
KA5L0165RI-YDTU	I ² -PAK-5L(Forming)				

Product Number	Package	Marking Code	BVDSS	FOSC	RDS(on)
KA5H0165RV-TU	TO-220F-4L	5H0165RV	650V	100kHz	8Ω
KA5H0165RV-YDTU	TO-220F-4L(Forming)				
KA5M0165RV-TU	TO-220F-4L	5M0165RV	650V	67kHz	8Ω
KA5M0165RV-YDTU	TO-220F-4L(Forming)				
KA5L0165RV-TU	TO-220F-4L	5L0165RV	650V	50kHz	8Ω
KA5L0165RV-YDTU	TO-220F-4L(Forming)				
KA5H0165RVN	8-DIP	5H0165RV	650V	100kHz	8Ω
KA5M0165RVN	8-DIP	5M0165RV	650V	67kHz	8Ω
KA5L0165RVN	8-DIP	5L0165RV	650V	50kHz	8Ω

TU : Non Forming Type

YDTU : Forming Type

DISCLAIMER

FAIRCHILD SEMICONDUCTOR RESERVES THE RIGHT TO MAKE CHANGES WITHOUT FURTHER NOTICE TO ANY PRODUCTS HEREIN TO IMPROVE RELIABILITY, FUNCTION OR DESIGN. FAIRCHILD DOES NOT ASSUME ANY LIABILITY ARISING OUT OF THE APPLICATION OR USE OF ANY PRODUCT OR CIRCUIT DESCRIBED HEREIN; NEITHER DOES IT CONVEY ANY LICENSE UNDER ITS PATENT RIGHTS, NOR THE RIGHTS OF OTHERS.

LIFE SUPPORT POLICY

FAIRCHILD'S PRODUCTS ARE NOT AUTHORIZED FOR USE AS CRITICAL COMPONENTS IN LIFE SUPPORT DEVICES OR SYSTEMS WITHOUT THE EXPRESS WRITTEN APPROVAL OF THE PRESIDENT OF FAIRCHILD SEMICONDUCTOR CORPORATION. As used herein:

1. Life support devices or systems are devices or systems which, (a) are intended for surgical implant into the body, or (b) support or sustain life, and (c) whose failure to perform when properly used in accordance with instructions for use provided in the labeling, can be reasonably expected to result in a significant injury of the user.
2. A critical component in any component of a life support device or system whose failure to perform can be reasonably expected to cause the failure of the life support device or system, or to affect its safety or effectiveness.