

KA710/I

SINGLE COMPARATOR

HIGH SPEED VOLTAGE COMPARATOR

The KA710/I is a high speed voltage comparator intended for use as an accurate, low-level digital level sensor or as a replacement for operational amplifiers in comparator applications where speed is of prime importance.

The output of the comparator is compatible with all intergrated logic forms.

The KA710/I is useful as pulse height discriminators, a variable threshold Schmitt trigger, voltage comparators in high-speed A/D converters, a memory sense amplifier or a high noise immunity line receiver.

14 DIP

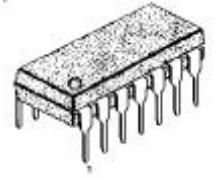

14 SOP

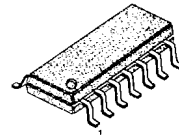

FEATURES

- γ Low offset voltage: 5mV
- γ High gain: 1000 V/V
- γ High speed: 40ns Typ

BLOCK DIAGRAM

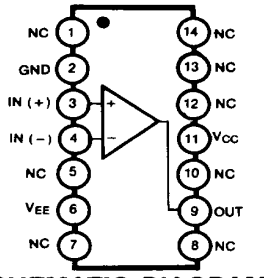

ORDERING INFORMATION

Device	Package	Operating Temperature
KA710	14 DIP	
KA710D	14 SOP	
KA710I	14 DIP	
KA710ID	14 SOP	

SCHEMATIC DIAGRAM

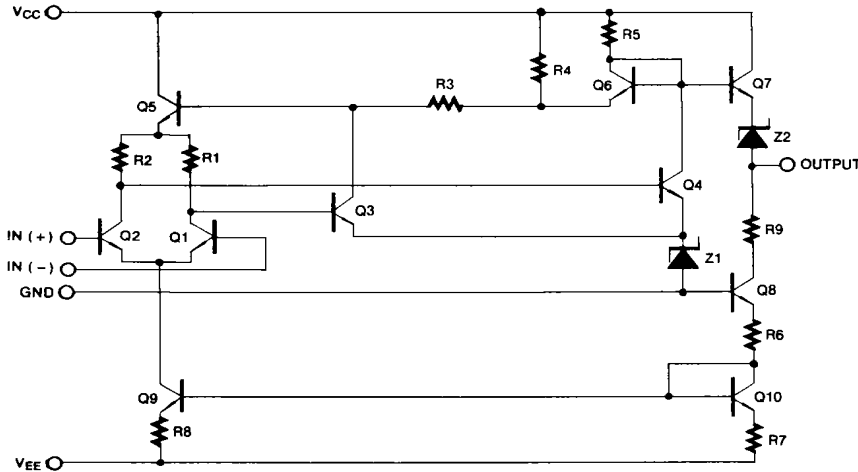

KA710/I

SINGLE COMPARATOR

Characteristic	Symbol	Value	Unit
Positive Supply Voltage	V_{CC}	+14	V
Negative Supply Voltage	V_{EE}	-7	V
Peak Output Current	I_{PK}	10	mA
Output Short Circuit Duration		10	Sec
Differential Input Voltage	$V_{I(DIFF)}$	≥ 5	V
Input Voltage	V_I	≥ 7	V
Power Dissipation	P_D	300	mW
Operating Temperature Range KA710		0 ~ +70	
KA710I		-25 ~ +85	
Storage Temperature Range	T_{STG}	-65 ~ +150	$^{\circ}C$

ABSOLUTE MAXIMUM RATINGS

ELECTRICAL CHARACTERISTICS ($V_{CC} = +12V$, $V_{EE} = -6V$, $T = 25^{\circ}C$, unless otherwise specified)

			KA710I			KA710			
			Min	Typ	Max	Min	Typ	Max	
				0.6	2.0		1.6	5.0	
		Note 2			3.0			6.5	
Input Offset Current (Note 1)		NOTE 1		0.75	3.0		1.8	5.0	
		Note 2		1.8	7.0			7.5	
				5.0	20		7.0	25	
		Note 2		27	45		25	40	
			1250	1800		1000	1700		
		Note 2							
Input Voltage Range	$V_{I(R)}$	$V_{CC} = -7V$	≥ 5.0			≥ 5.0			V
Common Mode Rejection Ratio	CMRR	$R_{SI} 200\Omega$, NOTE 2	80	95		70	94		dB
Differential Input Voltage Range	$V_{ID(R)}$		≥ 5.0			≥ 5.0			V
Positive Output Level	$V_{O(H)}$	$0 \leq I_{Oj} \leq 5mA$, $V_{Ij} \leq 5mV$	2.5	2.9	4.0	2.5	2.9	4.0	V
Negative Output Level	$V_{O(L)}$	$V_{Ij} \leq 5mV$	-1.0	-0.5	0	-1.0	-0.5	0	V
Output Sink Current	I_{SINK}	$V_{O(P)} = 0V$, $V_{Ij} \leq 5mV$	2.0	2.2		1.6	2.2		mA
Positive Supply Current	I_{CC}	$V_{O(P)} \leq 0V$		4.7	9.0		4.7	9.0	mA
Negative Supply Current	I_{EE}	$V_{O(P)} = 0V$, $V_{Ij} \leq 5mV$		4.0	7.0		4.0	7.0	mA
Power Consumption	P_D	$V_{O(P)} = 0V$, $V_{Ij} \leq 10mV$		80	150			150	mW
Response Time	t_{RES}	(Note 3)		40			40		nS

Note 1. The input offset voltage and input offset current are specified for a logic threshold voltage as follows:

For 710I, 1.65V at $-25^{\circ}C$, 1.4V at $+25^{\circ}C$, 1.15V at $+85^{\circ}C$. For 710, 1.5V at $0^{\circ}C$, 1.4V at $+25^{\circ}C$, 1.2V at $+70^{\circ}C$.

Note 2. KA710: $0 \leq I_{TAj} \leq +70^{\circ}C$

KA710I: $-25 \leq I_{TAj} \leq +85^{\circ}C$

Note 3. The response time specified is a 100mV input step with 5mV overdrive (KA710).

Fig. 1 SUPPLY CURRENT

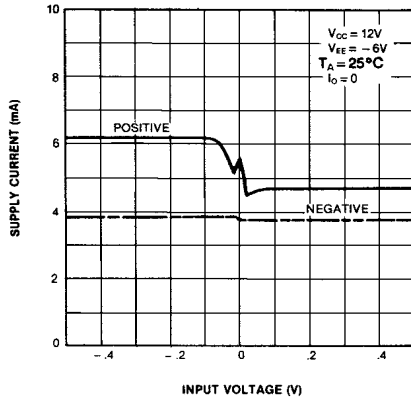

Fig. 2 VOLTAGE GAIN

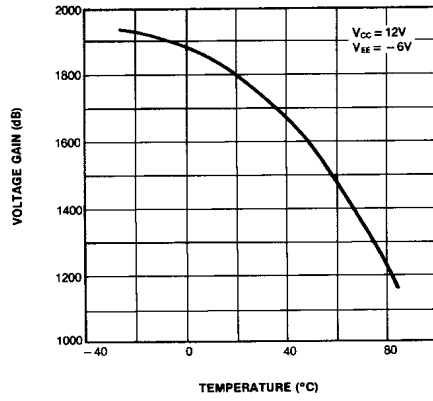

Fig. 3 INPUT OFFSET CURRENT

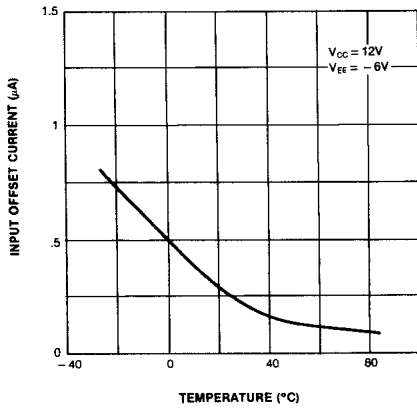

Fig. 4 INPUT BIAS CURRENT

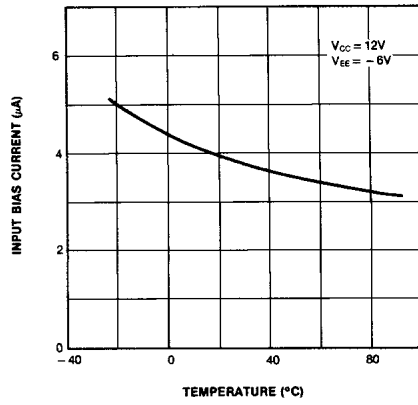

Fig. 5 OUTPUT VOLTAGE LEVEL

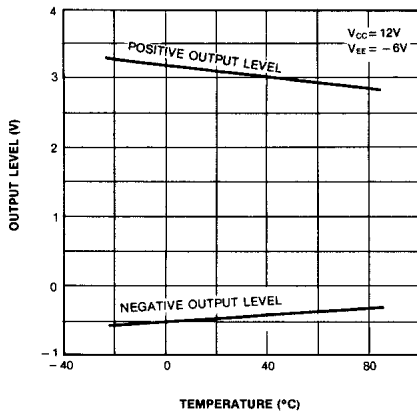

Fig. 6 OUTPUT SINK CURRENT

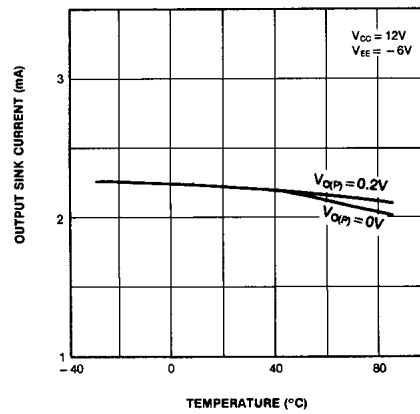

Fig. 7 RESPONSE TIME

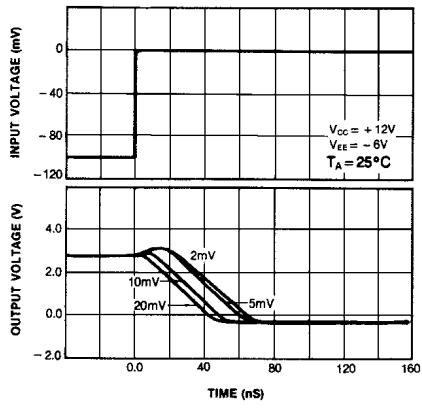

Fig. 8 RESPONSE TIME

