**Overview**

The LA7680 and LA7681 signal processors provide all the components required to decode PAL or NTSC Color television signals. On-chip circuits include VIF, SIF, a video processor, a chroma demodulator, and deflection drivers.

The self-adjusting signal processors support vertical field scanning rates of both 50 and 60Hz, allowing the LA7837 and LA7838 vertical output drivers to maintain a constant picture height.

The LA7681 replaces the LA7680's G-Y output at pin 22 with a color contrast signal for input to a SECAM chroma demodulator. This contrast signal is fixed at the maximum.

The LA7680/7681 is available in 48-pin shrink DIPs.

Features

- Minimized external components

- 48-pin shrink DIP

VIF/SIF

- High-gain VIF amplifier

- Fast-response automatic gain control (AGC)

- No delay between audio input and output

- Muting for both audio and video signals or for audio alone

Video processor

- On-chip two-dimensional differential circuit

- Variable current transfer

- 7MHz bandwidth

Chroma demodulator

- PAL and NTSC system compatible

- Optimized demodulation angles and ratios

- High performance burst cleaning filter and ACC/killer detector

- On-chip tint circuit (NTSC only)

Deflection drivers

- Adjustment-free vertical or horizontal synchronization

- Two-stage automatic frequency control

- Adjustable separation sensitivity for vertical synchronization

- Fixed picture height for both PAL and NTSC

- Fixed picture height

Package Dimensions

unit:mm

3149

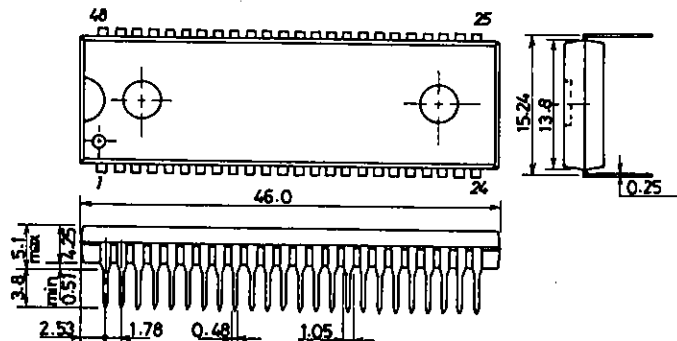

SANYO:DIP48S

SANYO Electric Co., Ltd. Semiconductor Business Headquarters
TOKYO OFFICE Tokyo Bldg., 1-10, 1 Chome, Ueno, Taito-ku, TOKYO, 110 JAPAN

LA7680, 7681

Absolute Maximum Ratings at Ta=25°C

			unit
Input Voltage	V13 max	12	V
	V11 max	12	V
Input Current	I25 max	16	mA
Allowable Power Dissipation	Pd max	1.35	W
FBP Input Current	I26 max	5	mA
	I24 max	10	mA
FBP Input Voltage	V26 min	-5	V
Operating Temperature	Topr	-10~+65	°C
Storage Temperature	Tstg	-55~+150	°C

Recommended Operating Conditions at Ta=25°C

			unit
Supply Voltage	V13	9	V
	V11	9	V
Supply Current	I25	13	mA
Operating Voltage Range	V13 op	8~10	V
	V11 op	8~10	V
Operating Current Range	I25 op	10~16	mA

Operating Characteristics at Ta=25°C, Vcc=V13=V11=9V, Icc=I25=13mA

		min	typ	max	unit	
[Supply Characteristics]						
Horizontal Supply Voltage	V25	7.0	7.5	8.0	V	
Supply Current	I11+13	90	110	140	mA	
[VIF Characteristics]fp=38.9MHz						
Video Output Voltage	V42	With no inputs	4.2	4.6	5.0	V
AFT Output Voltage	V44	With no inputs	2.8	4.2	5.7	V
Maximum RF AGC Voltage	V46H	{ CW=85dBμ RF AGC VR=min	7.6	8.0	8.3	V
Minimum RF AGC Voltage	V46L	{ CW=85dBμ RF AGC VR=max	0	0.01	0.3	V
Input Sensitivity	Vi	{ VIF input level generating 0.8Vp-p video output with 40% modulation	30	36	42	dBμ
AGC Range	GR	{ Maximum input(Vo=0.8Vp-p) less input sensitivity	60	68		dB
Maximum Input	Vi max	{ VIF input level generating +1dB video output	100	107		dBμ
Video Output Amplitude	Vo42	Vi=80dBμ, AM=78%MOD	1.7	2.0	2.3	Vp-p
Differential Gain	DG	{ Vi=80dBμ, 87.5% Video MOD		3.0	10	%
Differential Phase	DP	{ Vi=80dBμ, 87.5% Video MOD		3.0	10	deg
Video Signal-to-Noise Ratio	S/N	{ Vi=80dBμ, 20 log $\frac{1.43(Vp-p)}{\text{noise}(Vrms)}$	47	53		dB
Sync Signal Tip Level	V42 TIP	CW=80dBμ	2.0	2.3	2.6	V
Frequency Characteristic	fc	{ Frequency generating -3dB video output	7	10		MHz
VIF Intermodulation	I1.07	V4.43MHz/V1.07MHz, Vi=80dBμ	35	42		dB

Continued on next page.

LA7680, 7681

Continued from preceding page.

			min	typ	max	unit
Maximum AFT Output Voltage	V44H	CW=80dBu, over a range of frequencies	8.0	8.3	8.7	V
Minimum AFT Output Voltage	V44L	CW=80dBu, over a range of frequencies	0.2	0.4	0.9	V
AFT Detector Sensitivity	Sf	CW=80dBu, over a range of frequencies	35	60	90	mV/kHz
AFT Defeat Switching Voltage	V _{AFT SW}	Measured at sweep signal	1.0	5.0		V
Black Noise Threshold	V _{BTH}	Measured at sweep signal	1.2	1.5	1.8	V

[SIF Characteristics] f_s=5.5MHz

SIF Limiting Voltage	V _{lim}	[SIF input level generating -3 dB video output		45	52	dB μ
FM Detector Output Voltage	V _{O1}	V _i =100dB μ , Δf = ± 30 kHz	480	680	880	mVrms
FM Detector Output Distortion	THD	V _i =100dB μ , Δf = ± 30 kHz		0.4	1.0	%
AM Rejection	AMR	V _i =100dB μ , $\frac{FM:\Delta f=\pm 30kHz}{AM:30\%}$	43	56		dB
AF Amplifier Voltage Gain	G _{AF}	V _i =100mVrms, f=400Hz	18	20	22	dB
Maximum AF Amplifier Output Voltage	V _{O5 max}	[Output level generating 10% AF amplifier output distortion	2.0	2.8		Vrms
Maximum Attenuation For Electronically Variable Resistors	ATT	V _i = 200mVrs, f=400Hz	70	80		dB

[Video Characteristics]

[Video Softener Range	Δ Soft	[f=2MHz, 100mVp-p, voltage at video tone variable resistor, 4 to 0V	-6	-4	-2	dB
[Video Sharpener Range	Δ Sharp	[f=2MHz, 100mVp-p, voltage at video tone variable resistor, 4 to 9V	7	10	13	dB
Video Voltage Gain	G _V	[f=100kHz, 100mVp-p, voltage at contrast variable resistor 9V, voltage at video tone variable resistor 4V	17	20	23	dB
[Contrast Control Center Setting	CCEN	[f=100kHz, 100mVp-p, voltage at contrast variable resistor 6V	0.45	0.57	0.69	Vp-p
[Contrast Control Range	Δ Cv	[f=100kHz, 100mVp-p, voltage at contrast variable resistor 3 to 9V	20	22	24	dB
Brightness Control	BRH	Voltage at brightness variable resistor 2V	5.8			V
	BR _{CEN}	Voltage at brightness variable resistor 4.5V	2.6	3.1	3.6	V
	BRL	Voltage at brightness variable resistor 7V			1.2	V
Video Frequency Characteristic	f _V	Voltage at contrast variable resistor 6V, voltage at video tone variable resistor 4V, 3 dB down	5	7		MHz
Direct Current Transfer Rate	RDC	200mVp-p staircase input	88	93		%

[PAL/NTSC Chroma Characteristics]

Color Control Chrominance Residue	E _{C min}	[Voltage at color variable resistor 0V, voltage at color contrast variable resistor 9V			30	mVp-p
[LA7680 Color Contrast Range	Δ Cc	[Voltage at color variable resistor B-Y=2.5Vp-p, voltage at contrast variable resistor: 3 to 9V	18.5	20	21.5	dB
[LA7681 Color Contrast Output Voltage	V _{cout}	[Voltage at color variable resistor 4.5V, voltage at contrast variable resistor 6V	5.8	6.0	6.1	V
Demodulator Output DC Voltage	V _{C-Y}	[For burst signals only. Voltage at color variable resistor 0V	4.7	5.2	5.7	V
Demodulator Output DC Voltage Difference	Δ V _{C-Y}	[For burst signals only. Voltage at color variable resistor 0V	-300	0	300	mV
Demodulator Output Carrier Leakage Voltage	E _{car}				0.3	Vp-p
APC Pull-in Range	Δ f _{APC}		± 500			Hz

Continued on next page.

LA7680, 7681

Continued from preceding page.

			min	typ	max	unit
[PAL Chroma Characteristics]						
Contrast Control Center Setting	Ec cen	Voltage at color variable resistor: 4.5V (LA7680)	1.0	1.5	2.0	Vp-p
		Voltage at contrast variable resistor: 6V (LA7681)	1.9	2.6	3.3	Vp-p
ACC Amplitude Characteristic	ACCM1p	+6 dB	-3	0	+3	dB
	ACCM2p	-20dB	-5	-1	+1	dB
Demodulator Output Ratios	B/Rp	(Common to both LA7680 and LA7681)	1.50	1.78	2.00	
	G/Rp	With no B-Y signal(LA7680 only)	-0.56	-0.51	-0.46	
	G/Bp	With no R-Y signal(LA7680 only)	-0.21	-0.19	-0.17	
Demodulation Angle	∠RBP		85	90	95	deg
Maximum Chrominance Output	Ech	Voltage at color variable resistor 9V, voltage at contrast variable resistor 9V	1.0	1.5	2.0	Vp-p
Maximum Demodulator Output	Ecmx	Voltage at color variable resistor 9V, voltage at contrast variable resistor 9V	3.4	4.0		Vp-p
Killer Trigger Point	Ekonp		-35	-31	-27	dB
[NTSC Chroma Characteristics]						
Contrast Control Center Setting	Ec cenN	Voltage at color variable resistor 4.5V (LA7680)	0.7	1.1	1.5	Vp-p
		Voltage a contrast variable resistor 6V (LA7681)	1.3	1.8	2.3	Vp-p
ACC Amplitude Characteristic	ACCM1N	+6 dB	-3	0	+3	dB
	ACCM2N	-20dB	-5		+1	dB
ACC Phase Characteristic	ACCP1N	+6 dB	-3	0	+3	deg
	ACCP2N	-20dB	-7		+7	deg
Tint Control Center Setting	TCEN	Voltage at tint variable resistor 4.5V Voltage at color variable resistor 4.5V Voltage at contrast variable resistor 6V	-9	+3	+15	deg
Tint Range	ΔT	Voltage at tint variable resistor 0 to 4.5 to 9V Voltage at color variable resistor 4.5V Voltage at contrast variable resistor 6V	±40			deg
Demodulator Output Ratio	R/BN	Voltage at tint variable resistor 0 to 4.5 to 9V Voltage at color variable resistor 4.5V Voltage at contrast variable resistor 6V	0.81	0.90	0.98	
	G/BN	(LA7680)	0.24	0.3	0.38	
Demodulator Angle	∠RBN		90	96	102	deg
	∠GBN	(LA7680)	-131	-121	-111	deg
Killer Trigger Point	EkonN		-38	-34	-30	dB
Maximum Demodulator Output	EcmxN	Voltage at color variable resistor 9V, voltage at contrast variable resistor 9V	2.8	3.4		Vp-p
[Deflection Characteristics]						
Synchronization Separator Input Voltage	VSDC		6.0	6.3	6.6	V
Vertical Free-Running Frequency (50Hz)	Tvfree50			312.5		H
Vertical Free-Running Frequency (60Hz)	Tvfree60			262.5		H
Maximum Vertical Synchronization Frequency (50Hz)	Tv max50	With horizontal synchronization signal only		357		H
Maximum Vertical Synchronization Frequency (60Hz)	Tv max60	With horizontal synchronization signal only		297		H
Minimum Vertical Synchronization Frequency (60Hz)	Tv min60			225		H
Minimum Vertical Synchronization Frequency (50Hz)	Tv min50			269		H
Vertical Blanking Pulse Level	VH VBL		7.0	7.5		V
Vertical Blanking Pulsewidth (50Hz)	PWBLK50			21.5		H

Continued on next page.

LA7680, 7681

Continued from preceding page.

		min	typ	max	unit	
Vertical Blanking Pulsewidth (60Hz)	PWBLK60		17.5		H	
	Vertical Output Pulsewidth	PW VOUT	8.5		H	
Vertical Output Voltage	VOUT H	5.7	6	6.3	V	
	VOUT M	4.3	4.6	4.9	V	
	VOUT L			0.3	V	
Vertical Deflection External Trigger Load Impedance	RTR	2.5	3.6		k Ω	
Vertical Deflection Automatic Synchronization Cutoff Voltage	VSAS		1.9	2.4	V	
Vertical Output Pulse Vcc Starting Level	SVV			4	V	
Horizontal Free-Running Frequency Deviation	ΔfH	Deviation from 15.680kHz	-100	0	100	Hz
Horizontal Free-Running Frequency Dependence on Vcc	ΔfHV_{CC}	$V_{25} = 6.6V$	2		Hz	
		(reference value)				
Horizontal Pull-in Range	fH PULL	Deviation from 15.680kHz	± 450		Hz	
Horizontal Output Pulse Vcc Starting Level	SHV		4.3	5	V	
	AFC II FBP Peak Level	FBPH	4.1	4.6	5.1	V
VCR Switch Input Level	VCR		1.3	2.0	V	
Horizontal Output Pulsewidth	PWHOUT	21.8	23.8	25.8	μS	
Horizontal Output Pulse Phase	HPF	12			μS	
	HPCEN	3.4	4.4	5.4	μS	
	HPR			0	μS	
Burst Gate Pulsewidth	PWBGP	2.7	3.7	4.7	μS	
Burst Gate Pulse Phase	TdBGP	0.2	0.6	1.2	μS	
Horizontal Synchronization Detector Threshold Level	HCOIN	4.2	4.5	4.8	V	
	50/60Hz, Output Voltage	V50	0.4	0.5	V	
	V60	2.8	3.5		V	
50/60Hz, Input Voltage	Vin60			8.7	V	
	Vin50	0.15			V	

Block Diagram: PAL/NTSC System

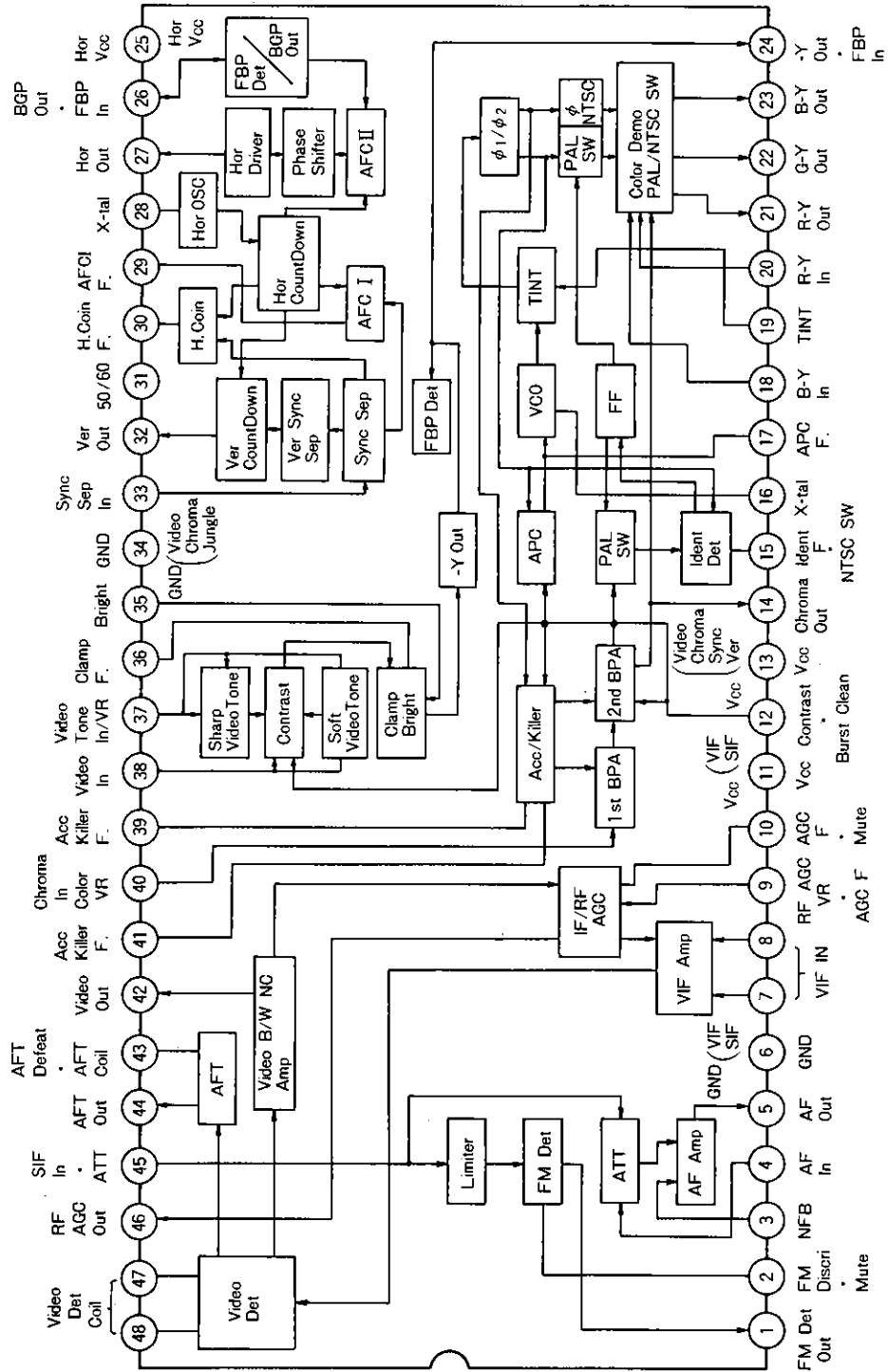

PAL Multi-sound System

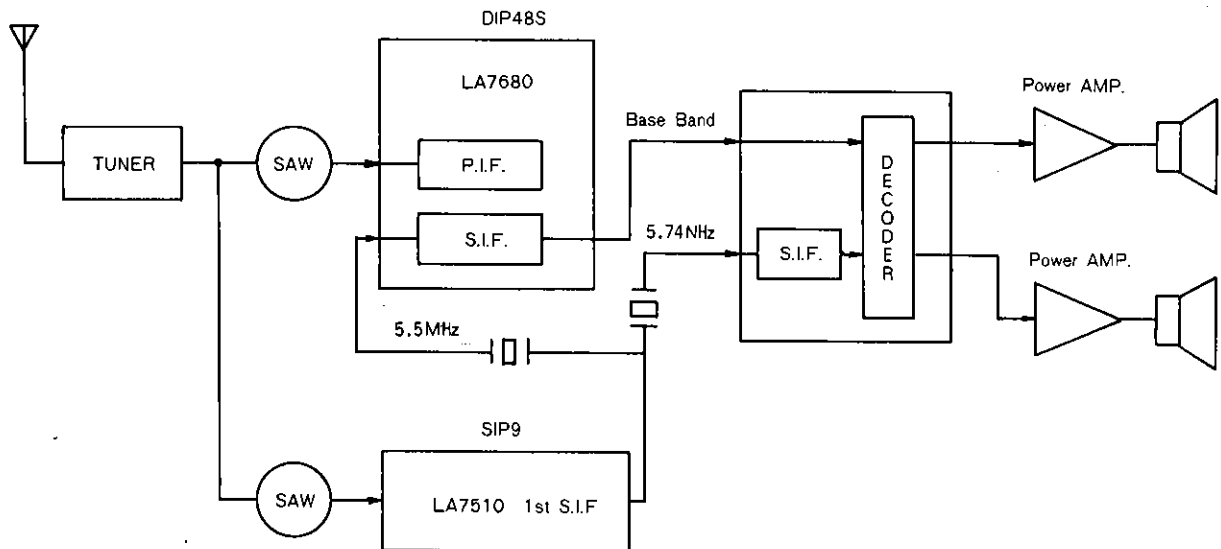

PAL Multi-sound System

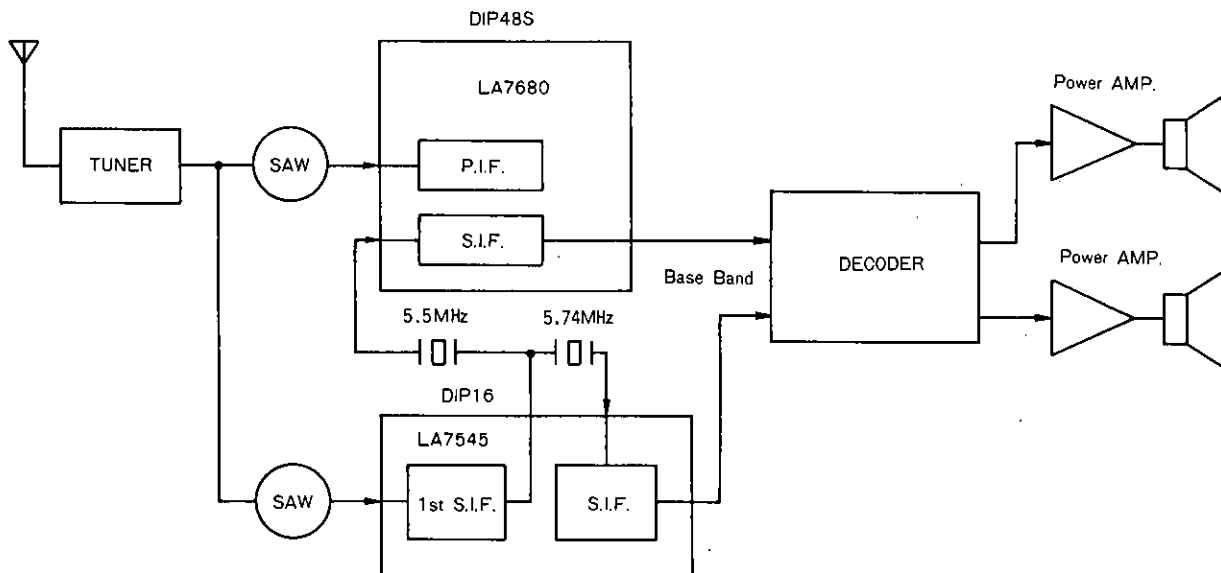

U.S. Multi-sound System

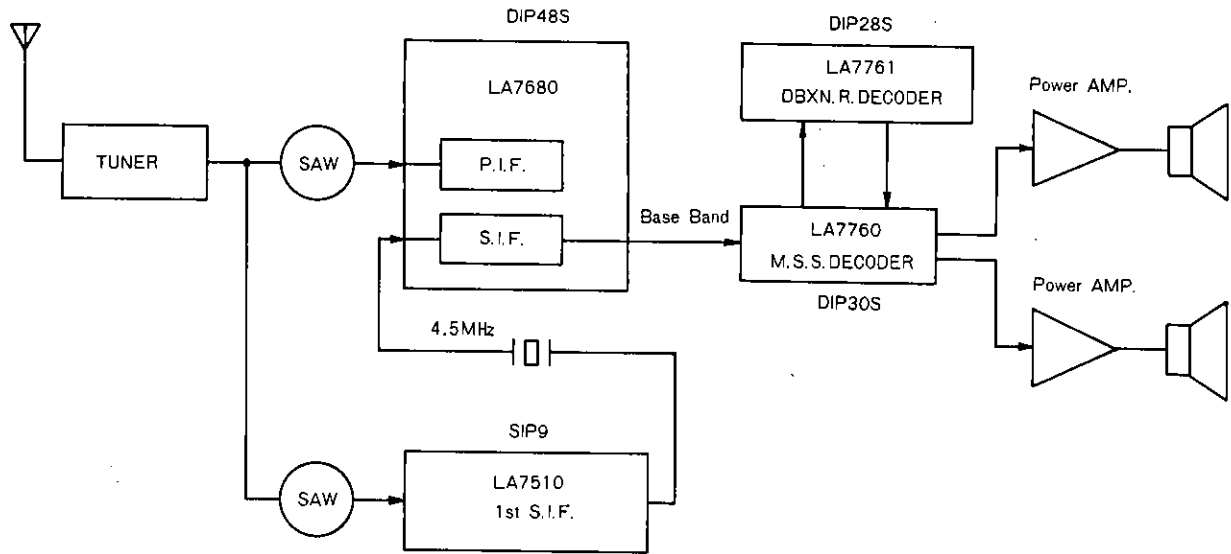

Sound Input/Output

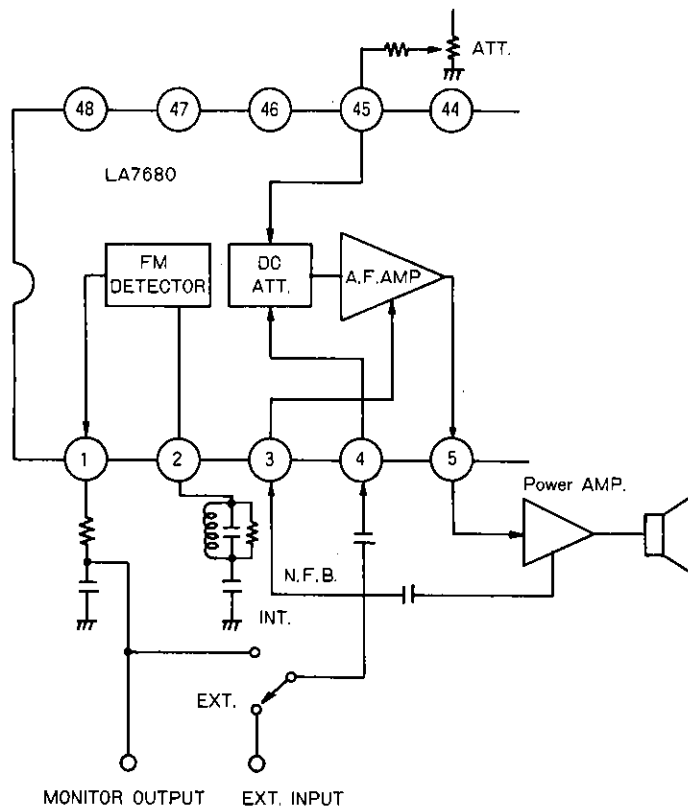

PAL/SECAM Chroma Demodulator Interface

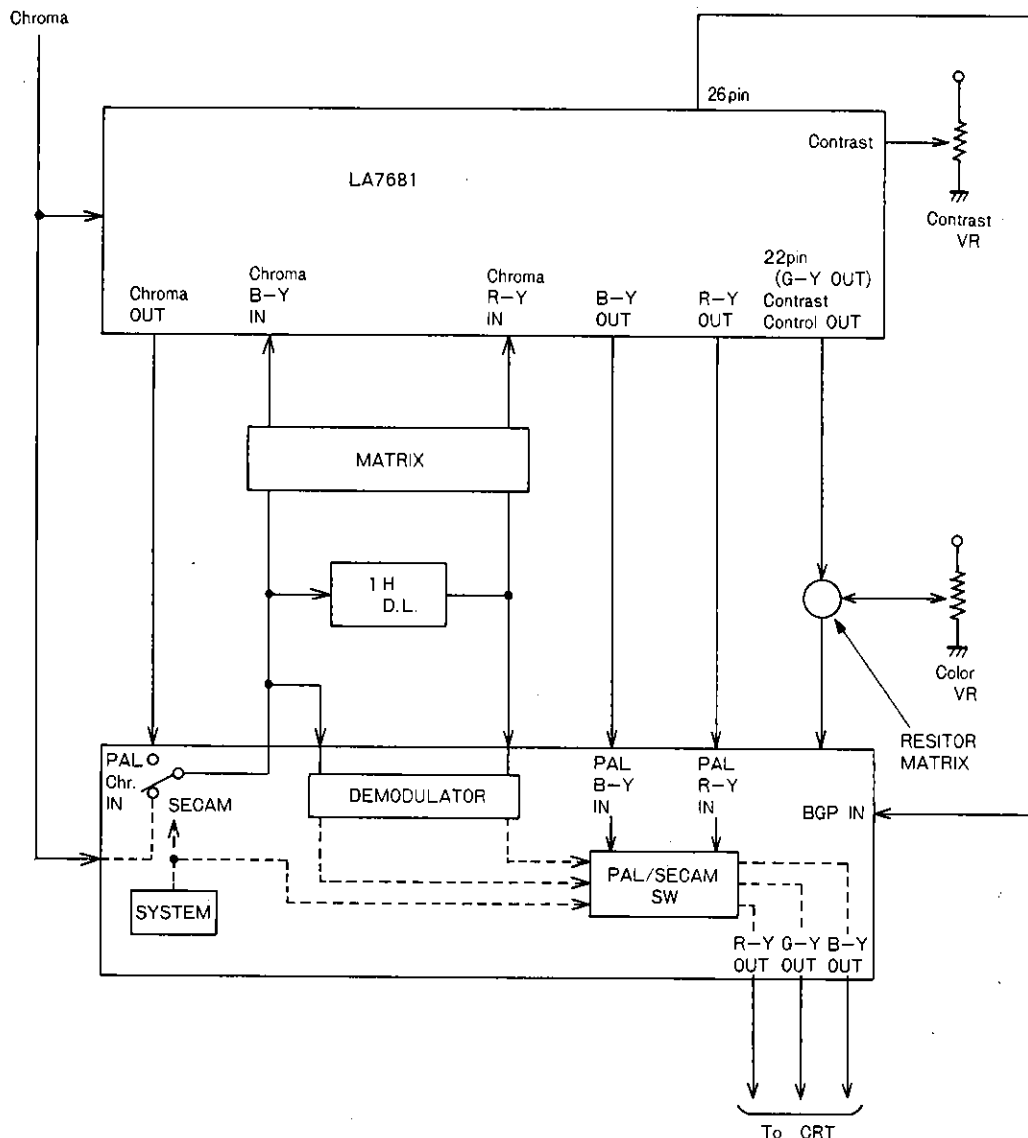

Note: The LA7680 may be used with the transcode type of SECAM chroma demodulators.

- No products described or contained herein are intended for use in surgical implants, life-support systems, aerospace equipment, nuclear power control systems, vehicles, disaster/crime-prevention equipment and the like, the failure of which may directly or indirectly cause injury, death or property loss.
- Anyone purchasing any products described or contained herein for an above-mentioned use shall:
 - ① Accept full responsibility and indemnify and defend SANYO ELECTRIC CO., LTD., its affiliates, subsidiaries and distributors and all their officers and employees, jointly and severally, against any and all claims and litigation and all damages, cost and expenses associated with such use.
 - ② Not impose any responsibility for any fault or negligence which may be cited in any such claim or litigation on SANYO ELECTRIC CO., LTD., its affiliates, subsidiaries and distributors or any of their officers and employees jointly or severally.
- Information (including circuit diagrams and circuit parameters) herein is for example only; it is not guaranteed for volume production. SANYO believes information herein is accurate and reliable, but no guarantees are made or implied regarding its use or any infringements of intellectual property rights or other rights of third parties.

This catalog provides information as of June, 1996. Specifications and information herein are subject to change without notice.