

SANYO

No. 2575B

LB1641**Bidirectional Motor Driver**

The LB1641 is a bidirectional motor driver IC. Since it has a 2-input logic circuit and performs the functions of bidirectional driving and braking, it is capable of direct driving 6V, 9V, 12V motors. The output voltage can be varied by using an external zener diode.

Features

- . 2-input logic can be used to exercise control of bidirectional driving and braking.
- . On-chip elements to absorb dash current of motor
- . Input interfaceable to MOS LSI
- . Output voltage variable by use of external zener diode

Absolute Maximum Ratings at Ta=25°C

			unit
Maximum Supply Voltage	V_{CCmax}	18	V
Input Voltage	V_{IN}	-0.3 to V_{CC}	V
Output Current	I_{OUT}	± 1.6	A
Allowable Power Dissipation	P_{dmax}	1.2	W
Operating Temperature	T_{opr}	-25 to +75	°C
Storage Temperature	T_{stg}	-55 to +125	°C

Allowable Operating Conditions at Ta=25°C

			unit
Supply Voltage	V_{CC1}	7 to 18	V
	V_{CC2}	5 to 18	V

Electrical Characteristics at Ta=25°C, $V_{CC}=12V$

			min	typ	max	unit
Input Threshold Voltage	V_{th}	$R_L = \infty$	1.1	1.3	1.5	V
Minimum Input ON-State Current	I_{IN}	$R_L = \infty$		10	15	μA
Output Voltage	V_O	$R_L = 60\text{ohms}, V_Z = 7.4V$	6.6	7.2	7.4	V
Output Leakage Current	I_{OL}	Pins 5, 6 GND, $R_L = \infty$		0.01	1.0	mA
Current Dissipation	I_{CC}	Pins 5, 6 GND, $R_L = \infty$	3	6	10	mA
Saturation Voltage (Upper)	V_{sat1}	$V_{CC} = 12V, I_{OUT} = 300mA$		1.9	2.2	V
	V_{sat1}	$V_{CC} = 12V, I_{OUT} = 500mA$		1.9	2.3	V
Saturation Voltage (Lower)	V_{sat2}	$V_{CC} = 12V, I_{OUT} = 300mA$		0.25	0.5	V
	V_{sat2}	$V_{CC} = 12V, I_{OUT} = 500mA$		0.4	0.65	V

Truth Table

Input		Output		Operation
IN1	IN2	OUT1	OUT2	
0	0	0	0	Braking
1	0	1	0	Forward (reverse) drive
0	1	0	1	Reverse (forward) drive
1	1	0	0	Braking

Input level 1: 2.0V or greater
 0: 0.7V or less

Package Dimensions 3043A

(unit: mm)

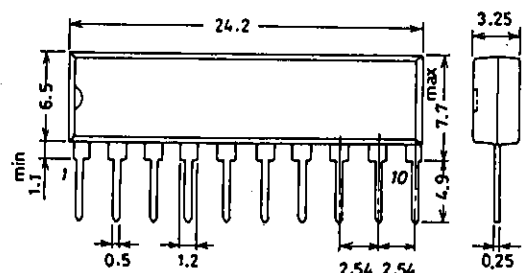

SANYO: SIP10

SANYO Electric Co., Ltd. Semiconductor Business Headquarters

TOKYO OFFICE Tokyo Bldg., 1-10, 1 Chome, Ueno, Taito-ku, TOKYO, 110 JAPAN

LB1641

Test Circuit

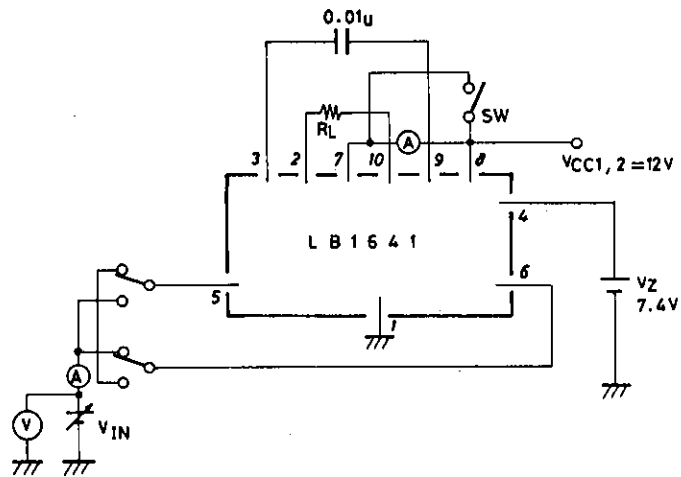

Unit (capacitance: F)

Sample Application Circuit: 6V motor circuit

Unit (resistance: Ω, capacitance: F)

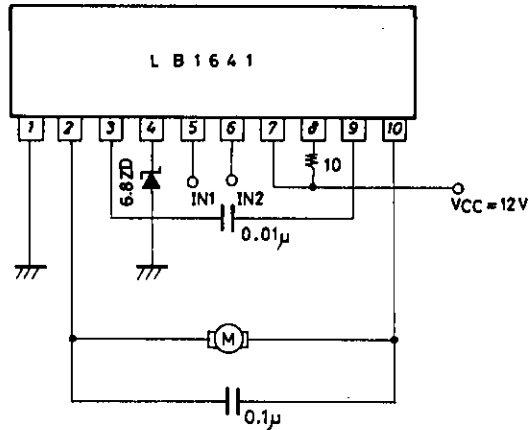

Equivalent Circuit Block Diagram

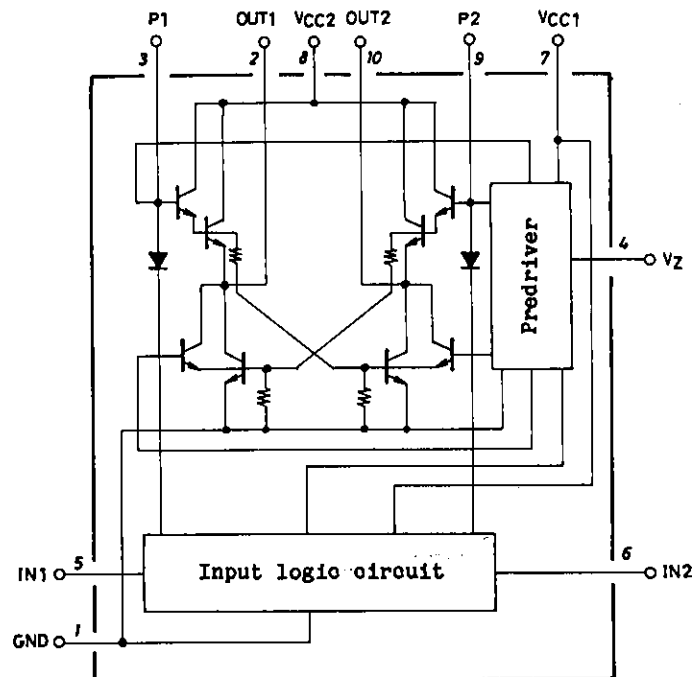

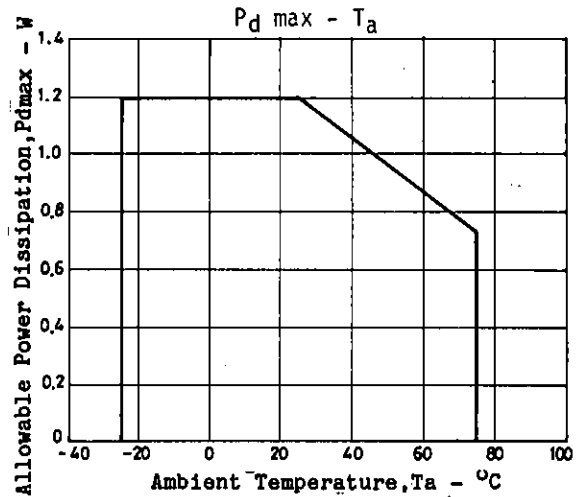
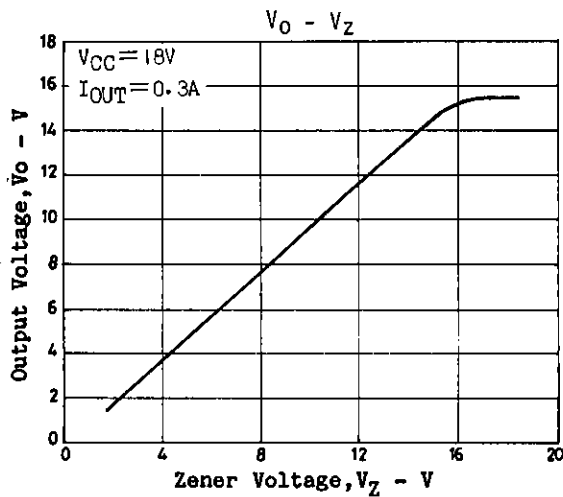
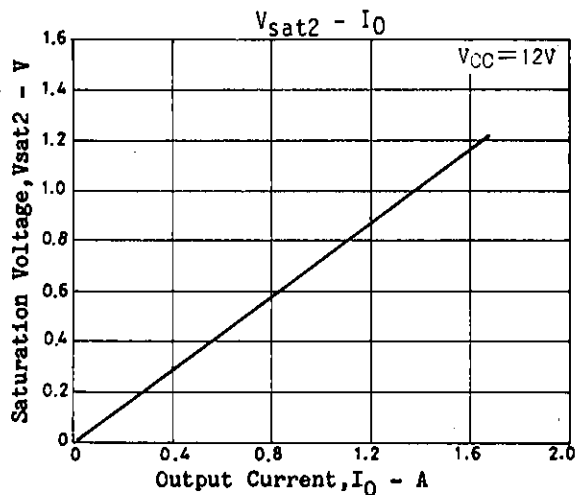
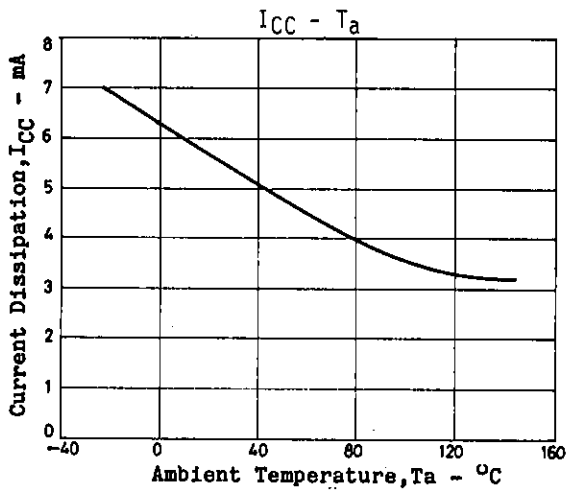
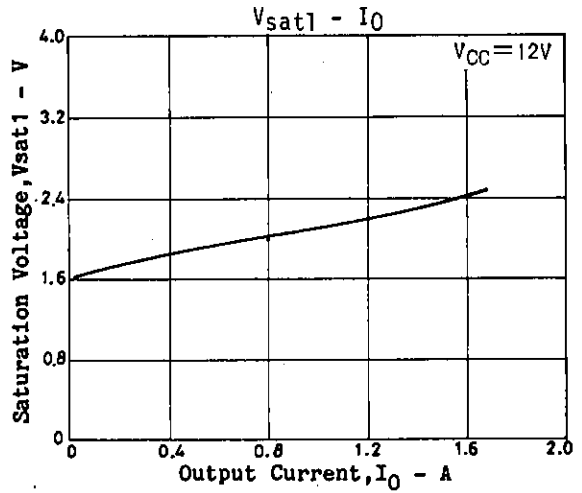
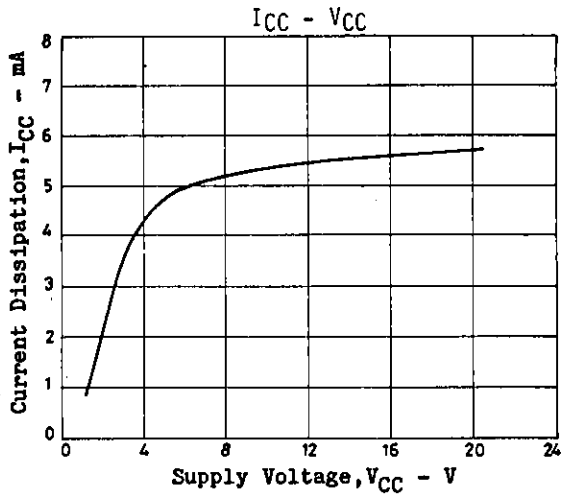

- No products described or contained herein are intended for use in surgical implants, life-support systems, aerospace equipment, nuclear power control systems, vehicles, disaster/crime-prevention equipment and the like, the failure of which may directly or indirectly cause injury, death or property loss.
- Anyone purchasing any products described or contained herein for an above-mentioned use shall:
 - ① Accept full responsibility and indemnify and defend SANYO ELECTRIC CO., LTD., its affiliates, subsidiaries and distributors and all their officers and employees, jointly and severally, against any and all claims and litigation and all damages, cost and expenses associated with such use:
 - ② Not impose any responsibility for any fault or negligence which may be cited in any such claim or litigation on SANYO ELECTRIC CO., LTD., its affiliates, subsidiaries and distributors or any of their officers and employees jointly or severally.
- Information (including circuit diagrams and circuit parameters) herein is for example only; it is not guaranteed for volume production. SANYO believes information herein is accurate and reliable, but no guarantees are made or implied regarding its use or any infringements of intellectual property rights or other rights of third parties.