

**Use**

Function switchover of amplifier, receiver, etc. and tape monitor control

**Features**

- (1) 2-channel 5-position source select + tape monitor on chip
- (2) Control input pins of input/output common type (Key input and LED display)
- (3) Delivers audio muting control signal.
- (4) Possible to select operation modes of backup mode, initialization mode, automatic switchover of function
- (5) Supply voltage  $\pm 20V$ , single-supply operation available

**Absolute Maximum Ratings at  $T_a = 25^\circ C, V_{SS} = 0V$**

Parameter	Symbol	Conditions	Min	Max	Unit
Maximum Supply Voltage	$V_{DD}$ max	$V_{DD}$	$V_{SS} - 0.3$	+20	V
	$V_{EE}$ max	$V_{EE}$	-20	$V_{SS} + 0.3$	V
Output Voltage	$V_{OUT}$	ACTL to ECTL TMOUT	$V_{SS} - 0.3$	$V_{DD} + 0.3$	V
Output Current	$I_{OUT}$	"		30	mA
Voltage Difference at Analog Switch-ON Mode	$\Delta V_{on}$	Switch ON		0.5	V
Allowable Power Dissipation	$P_d$ max	$T_a \leq 85^\circ C$		500	mW
Operating Temperature	$T_{opg}$		-30	+75	$^\circ C$
Storage Temperature	$T_{stg}$		-40	+125	$^\circ C$

**Allowable Operating Conditions at  $T_a = 25^\circ C, V_{SS} = 0V, |V_{DD}| \geq |V_{EE}|$**

Parameter	Symbol	Conditions	min	typ	max	unit
Supply Voltage	$V_{DD1}$	$V_{DD}$	$V_{SS} + 6$	$V_{SS} + 18.5$		V
	$V_{EE}$	$V_{EE}$	$V_{SS} - 18.5$	$V_{SS}$		V
	$V_{DD2}$	$V_{DD}$	$V_{SS} + 3$	$V_{SS} + 18.5$		V
		$V_{EE} \leq V_{SS}$ backup				V

**Pin Assignment**

Continued on next page.

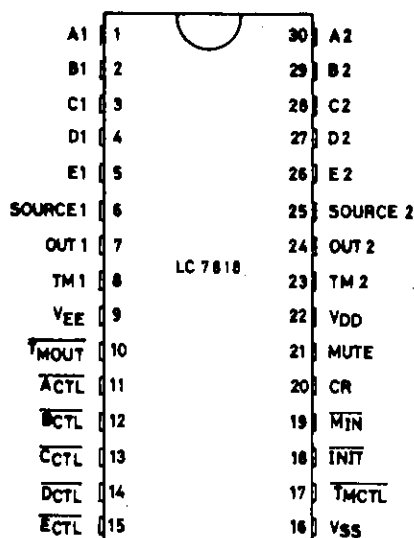

**Package Dimensions 3047A**  
(unit: mm)

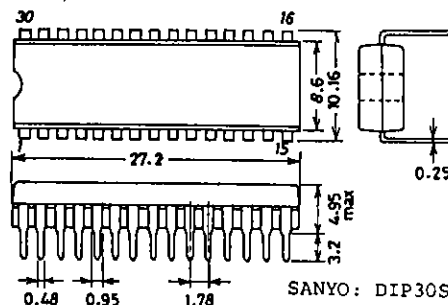

LC7818

Continued from preceding page.

			min	typ	max	unit
Input "H" Level Voltage	V <sub>IH</sub>	$\frac{\overline{ACTL} \text{ to } \overline{ECTL}}{\overline{TMCTL}}$	0.7V <sub>DD</sub>		V <sub>DD</sub>	V
		$\overline{Min}$	V <sub>DD</sub> -1.0		V <sub>DD</sub>	V
		$\overline{INIT}$	V <sub>SS</sub> +3.0		V <sub>DD</sub>	V
Input "L" Level Voltage	V <sub>IL</sub>	$\frac{\overline{ACTL} \text{ to } \overline{ECTL}}{\overline{TMCTL}}$	V <sub>SS</sub>	0.25V <sub>DD</sub>		V
		$\overline{Min}$	V <sub>SS</sub>	V <sub>SS</sub> +1.0		V
		$\overline{INIT}$	V <sub>SS</sub>	V <sub>SS</sub> +0.5		V
Input "M" Level Voltage	V <sub>IM</sub>	$\overline{Min}$	0.45V <sub>DD</sub>	0.55V <sub>DD</sub>		V
Analog Switch Input Voltage Range	V <sub>IN</sub>	A1 to E1, A2 to E2 SOURCE1,2 TM1,2	V <sub>EE</sub>		V <sub>DD</sub>	V

Electrical Characteristics at Ta = 25°C, V<sub>SS</sub> = 0V, |V<sub>DD</sub>| ≥ |V<sub>EE</sub>|

				min	typ	max	unit
Output "H" Level Voltage	V <sub>OH</sub>	MUTE	I <sub>OH</sub> = -0.4mA, V <sub>DD</sub> ≥ 9V	V <sub>DD</sub> -0.5		V <sub>DD</sub>	V
Output "L" Level Voltage	V <sub>OL1</sub>	$\frac{\overline{ACTL} \text{ to } \overline{ECTL}}{\overline{TMOUT}}$	I <sub>OL</sub> = 30mA, V <sub>DD</sub> = 18V	0		2	V
	V <sub>OL2</sub>	MUTE	I <sub>OL</sub> = 0.4mA, V <sub>DD</sub> ≥ 9V	0		0.5	V
Analog Switch-ON Resistance	R <sub>on</sub>	A1 to E1, A2 to E2 TM1, TM2	I = 1mA, V <sub>DD</sub> - V <sub>EE</sub> = 12V		120		Ω
		OUT1, OUT2	I = 1mA, V <sub>DD</sub> - V <sub>EE</sub> = 18V		80		Ω
			I = 1mA, V <sub>DD</sub> - V <sub>EE</sub> = 37V		70		Ω
Input/Output OFF Leak Current	I <sub>OFF1</sub>	$\frac{\overline{ACTL} \text{ to } \overline{ECTL}}{\overline{TMOUT}}$	V <sub>O</sub> = V <sub>SS</sub> + 18V			10	μA
	I <sub>OFF2</sub>	CR	V <sub>O</sub> = V <sub>SS</sub> + 18V			1	μA
	I <sub>OFF3</sub>	A1 to E1, A2 to E2 TM1, 2, OUT1, 2	Analog SW OFF V <sub>IN</sub> = V <sub>O</sub> = V <sub>EE</sub> to V <sub>EE</sub> + 37V	-1		1	μA
Total Harmonic Distortion	THD	SOURCE1, 2 OUT1, 2	V <sub>IN</sub> = 1V <sub>rms</sub> , f = 1kHz, V <sub>DD</sub> - V <sub>EE</sub> = 15 to 37V	0.0015	0.01		%
Feedthrough	F <sub>TH</sub>	A1 to E1 SOURCE1 OUT1 A2 to E2 SOURCE2 OUT2	V <sub>DD</sub> - V <sub>EE</sub> = 37V, f = 10kHz V <sub>IN</sub> = 0.77V <sub>rms</sub> R <sub>L</sub> = 47kΩ		55		dB
Crosstalk	CT	A1 to E1 SOURCE2 OUT2 A2 to E2 SOURCE1 OUT1	V <sub>DD</sub> - V <sub>EE</sub> = 37V, f = 10kHz V <sub>IN</sub> = 0.77V <sub>rms</sub> R <sub>L</sub> = 47kΩ		75		dB
Current Dissipation	I <sub>DD</sub>	V <sub>DD</sub>	Operating mode V <sub>DD</sub> - V <sub>EE</sub> = 37V			1	mA
Muting Time	T <sub>M</sub>	MUTE			OSC period x 21		
Input Accept Pulse Width (Switch Select)	T <sub>IN(1)</sub>	$\frac{\overline{ACTL} \text{ to } \overline{ECTL}}{\overline{TMCTL}}$			OSC period x 3		
Input Accept Pulse Width (Muting Output)	T <sub>IN(2)</sub>	$\frac{\overline{ACTL} \text{ to } \overline{ECTL}}{\overline{TMCTL}}$			OSC period x 1		
External Capacitance for CR OSC	C <sub>1</sub>	CR		0.001		0.1	μF
OSC Period	T <sub>1</sub>	CR	V <sub>DD</sub> - V <sub>SS</sub> = 6V	0.4C <sub>1</sub> R <sub>1</sub>	0.7C <sub>1</sub> R <sub>1</sub>		
	T <sub>2</sub>	CR	V <sub>DD</sub> - V <sub>SS</sub> = 18.5V	0.3C <sub>1</sub> R <sub>1</sub>	0.6C <sub>1</sub> R <sub>1</sub>		
Current Dissipation	I <sub>DD</sub> back up	V <sub>DD</sub>	back up V <sub>DD</sub> = 5V, V <sub>EE</sub> = V <sub>SS</sub> = 0V			1	μA

Operation caused by combination of INIT, Min inputs

INIT	Min	Operation
H	M	Normal
H	L	Backup
H	H	Auto function
L	M	Muting
L	L	Initialize (A circuit)
L	H	Reset

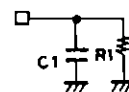

Pin Description

Pin Name	Pin No.	Input/Output Configuration	Function
V <sub>DD</sub> V <sub>SS</sub> V <sub>EE</sub>	22 16 9		<ul style="list-style-type: none"> <li>Power supply pin</li> <li>Single supply (+): V<sub>SS</sub>=V<sub>EE</sub>=GND</li> <li>Dual supply (±): V<sub>SS</sub>=GND, V<sub>EE</sub>=(-)V</li> </ul>
A <sub>1</sub> , B <sub>1</sub> C <sub>1</sub> , D <sub>1</sub> E <sub>1</sub> , TM <sub>1</sub> A <sub>2</sub> , B <sub>2</sub> C <sub>2</sub> , D <sub>2</sub> E <sub>2</sub> , TM <sub>2</sub> SOURCE1 SOURCE2 OUT1 OUT2	1, 2 3, 4 5, 8 30, 29 28, 27 26, 23 6 25 7 24		<ul style="list-style-type: none"> <li>A to E, TM: Audio signal input pin</li> <li>SOURCE: Output pin for REC</li> <li>OUT: Audio signal output pin</li> </ul>
TMOUT	10		<ul style="list-style-type: none"> <li>TM ON/OFF-state display LED driver output</li> </ul>
ACTL BCTL CCTL DCTL ECTL	11 12 13 14 15		<ul style="list-style-type: none"> <li>Input/output pin for analog switch control and its state display LED driver output</li> </ul>
TMCTL	17		<ul style="list-style-type: none"> <li>Input pin for TM control</li> </ul>
INIT	18		<ul style="list-style-type: none"> <li>Input pin for mode setting (Details are given on page 2.)</li> </ul>
MIN	19		<ul style="list-style-type: none"> <li>Input pin for mode setting (Details are given on page 2.)</li> </ul>
CR	20		<ul style="list-style-type: none"> <li>Input/output pin for clock generation</li> <li>C1, R1 are connected.</li> </ul>
MUTE	21		<ul style="list-style-type: none"> <li>Output pin for muting control</li> </ul>

Note: Priority for simultaneous push of keys is given as shown below.

TMCTL > ACTL > BCTL > CCTL > DCTL > ECTL

The pin (ACTL to ECTL pins) whose LED driver is turned ON (function selected) does not accept key input. Key input to such pin causes no operation to occur.

- No products described or contained herein are intended for use in surgical implants, life-support systems, aerospace equipment, nuclear power control systems, vehicles, disaster/crime-prevention equipment and the like, the failure of which may directly or indirectly cause injury, death or property loss.
- Anyone purchasing any products described or contained herein for an above-mentioned use shall:
  - ① Accept full responsibility and indemnify and defend SANYO ELECTRIC CO., LTD., its affiliates, subsidiaries and distributors and all their officers and employees, jointly and severally, against any and all claims and litigation and all damages, cost and expenses associated with such use.
  - ② Not impose any responsibility for any fault or negligence which may be cited in any such claim or litigation on SANYO ELECTRIC CO., LTD., its affiliates, subsidiaries and distributors or any of their officers and employees jointly or severally.
- Information (including circuit diagrams and circuit parameters) herein is for example only; it is not guaranteed for volume production. SANYO believes information herein is accurate and reliable, but no guarantees are made or implied regarding its use or any infringements of intellectual property rights or other rights of third parties.

Equivalent Circuit Block Diagram

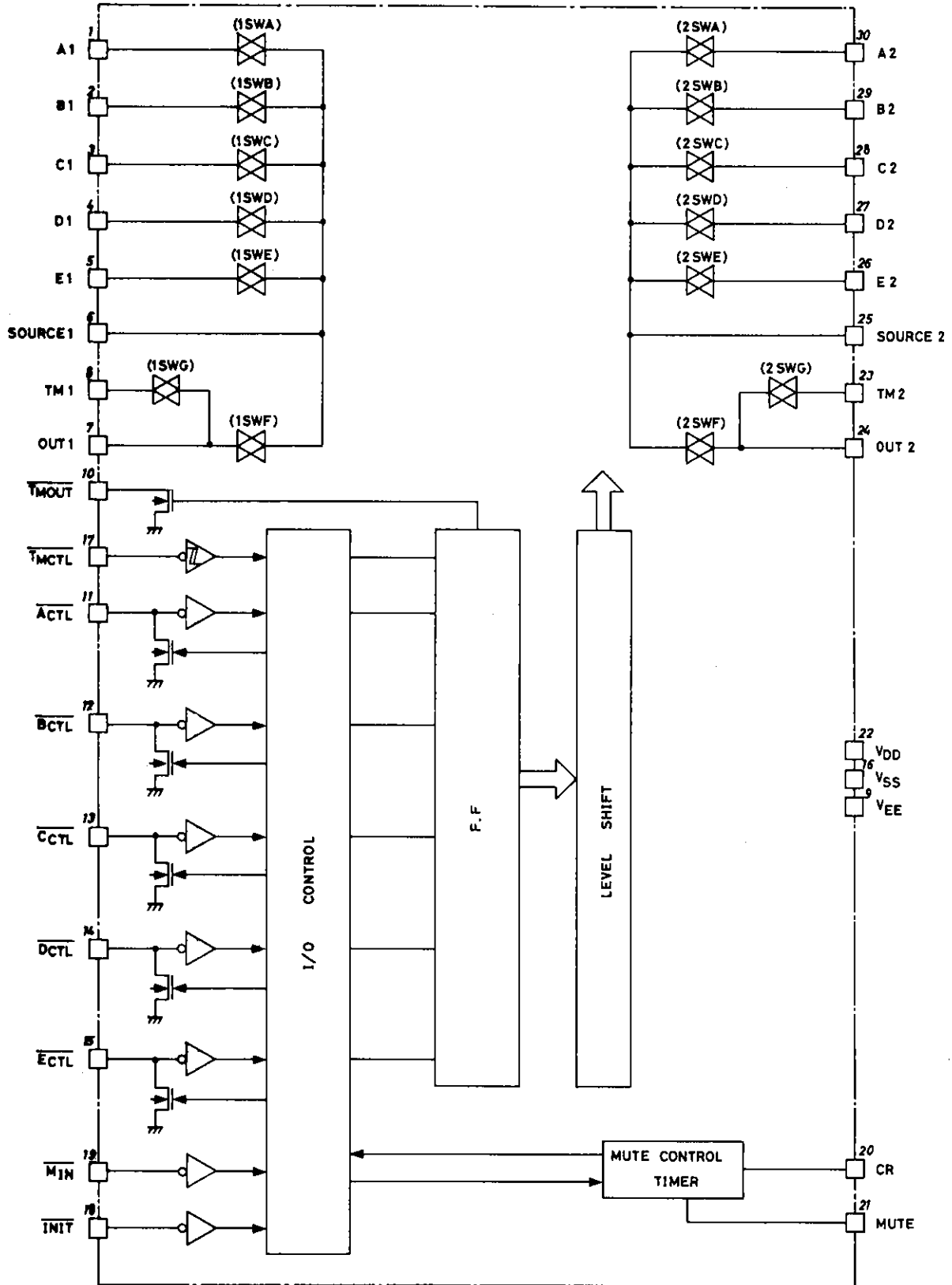

Application Circuit

- (1) Initialization, muting mode  
(One channel only is shown below.)

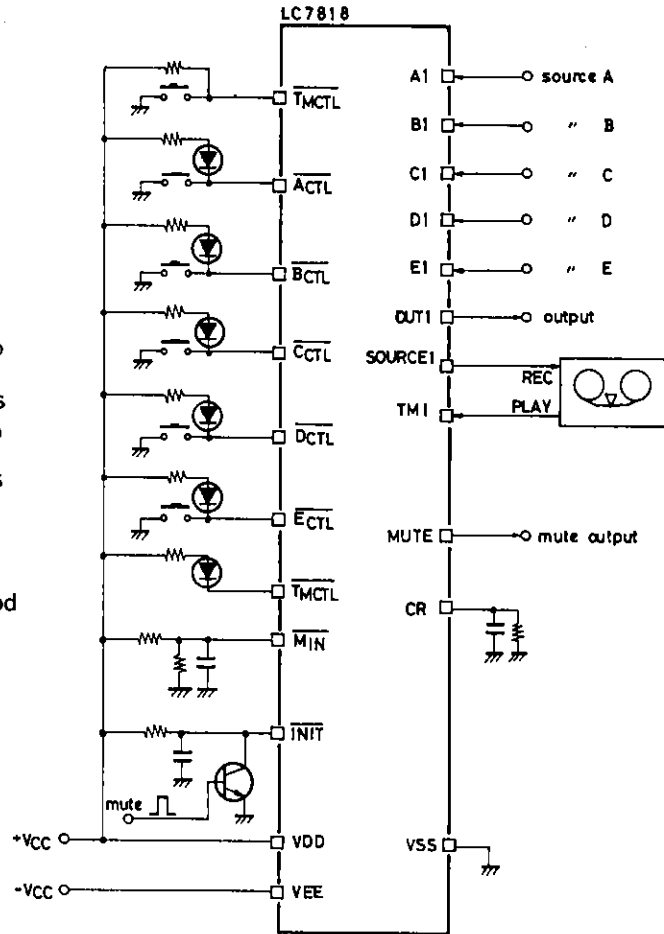
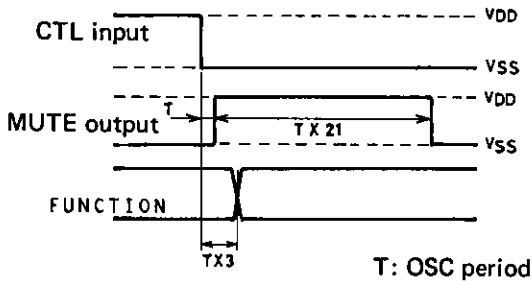

- (2) Backup mode  
(Audio section, MUTE circuit are omitted.)

If the power switch is set to the primary side at the backup mode and it takes time for +B to fall when power is turned OFF, the MIN pin must be brought to "L" state before the ACTL to ECTL, TMCTL pins are brought to "L" state or the MIN pin must be brought to "L" state within OSC period x 3 in case the ACTL to ECTL, TMCTL pins are brought to "L" state earlier; otherwise the function may be shifted to another.

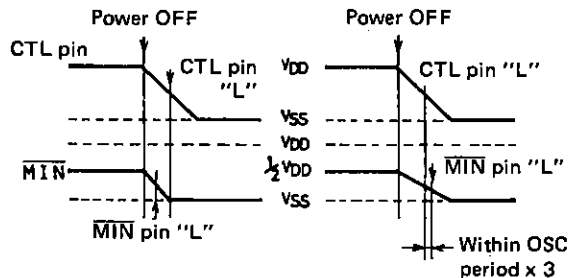
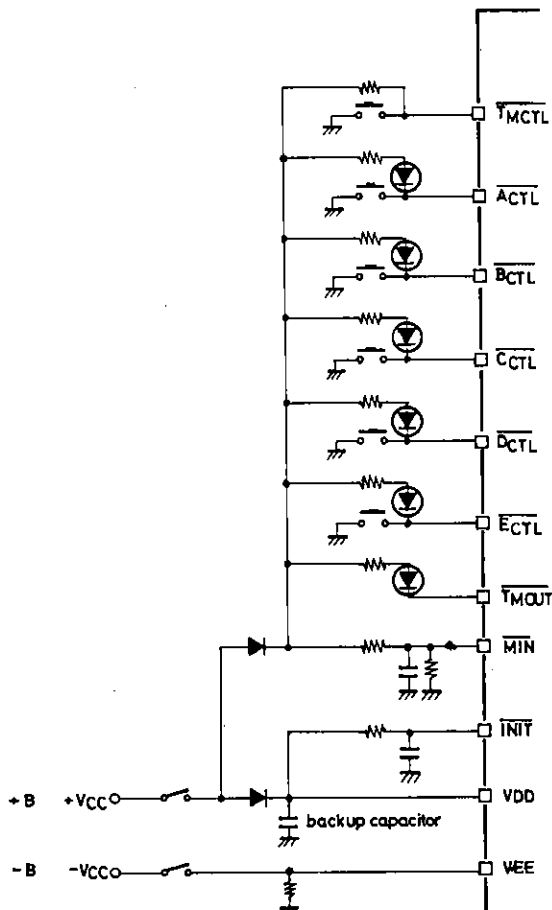

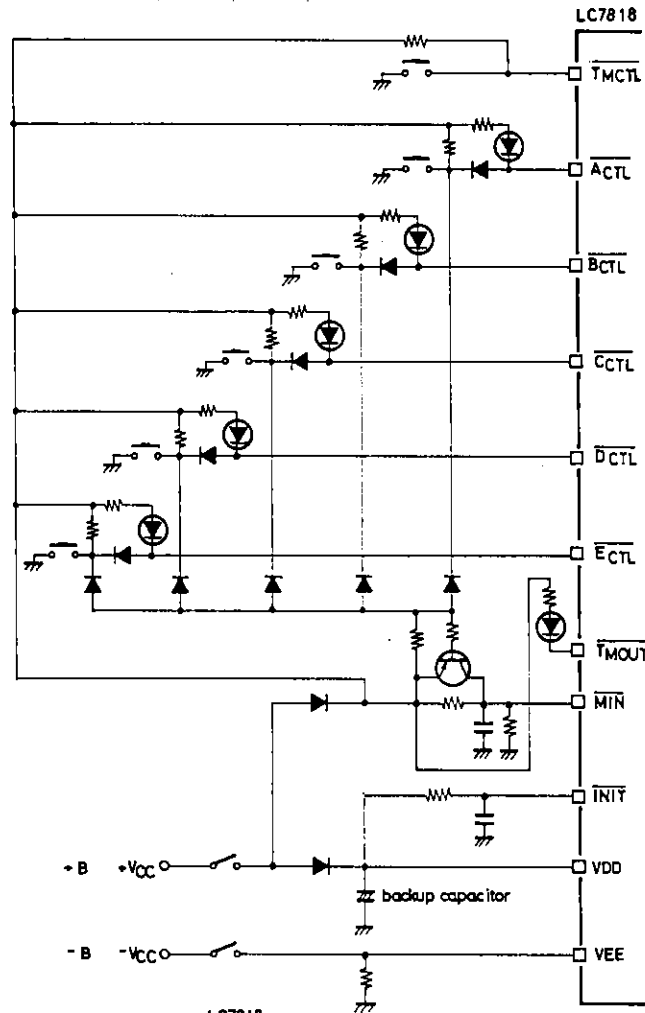

# LC7818

(3) Auto function, backup mode

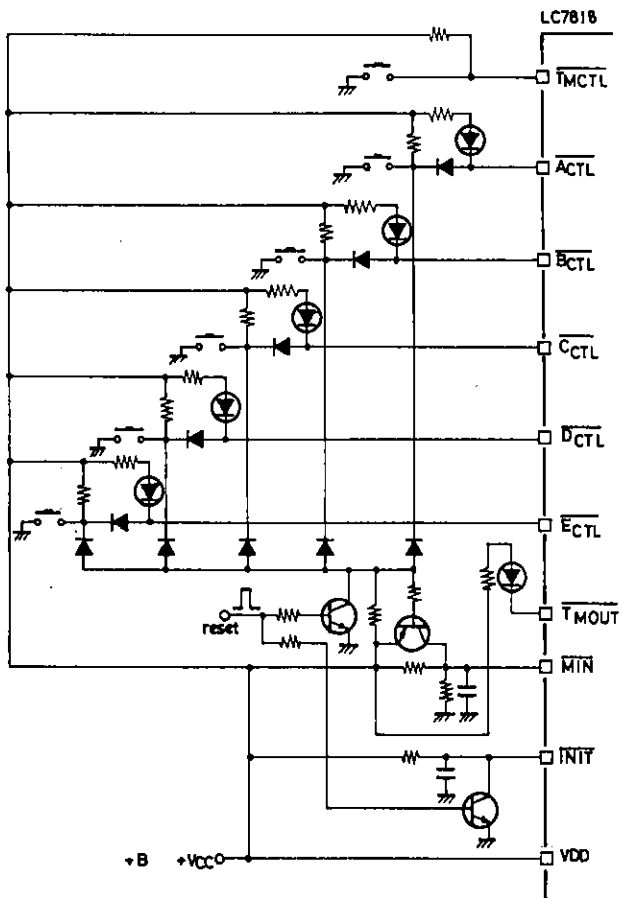

(4) Auto function, initialization, reset mode

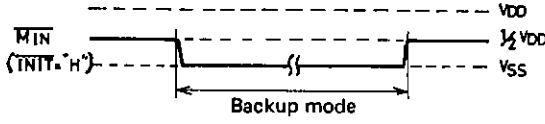
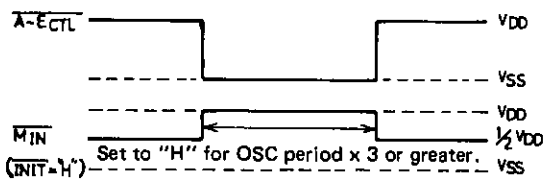
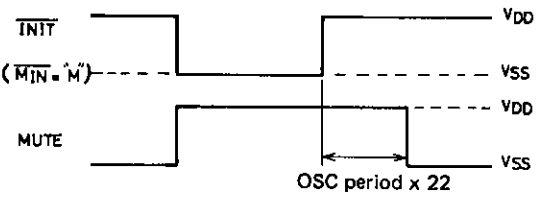

INIT	MIN	Operation	Description
H	M	Normal	<ul style="list-style-type: none"> <li>This state is kept at the normal operation mode.</li> </ul>
H	L	Backup mode	<ul style="list-style-type: none"> <li>The backup mode is entered at this state.</li> </ul> 
H	H	Auto function (TM reset)	<ul style="list-style-type: none"> <li>When the <math>\overline{ACTL}</math> to <math>\overline{ECTL}</math> input occurs, set to this state.</li> </ul> 
L	M	Muting	<ul style="list-style-type: none"> <li>When applying muting regardless of the function select key, set to this state.</li> </ul> 
L	L	Initialization (A circuit ON)	<ul style="list-style-type: none"> <li>The TM is turned OFF and the A circuit is turned ON.</li> </ul> 
L	H	Reset	<ul style="list-style-type: none"> <li>All input circuits are turned OFF.</li> </ul> 