

PBD 3548/1 Universal Source Driver

Description

PBD 3548/1 is a bipolar universal high-current highly-protected high side driver with transparent input and 2 A continuous-current source capability. A low-level input activates the output.

The driver is equipped with extensive electrical protection, such as overcurrent protection and thermal protection, which makes the device virtually indestructible. Furthermore it can detect open circuit and short circuit to V_{CC} .

A special feature is the Error indicating output function pin which signals to the host system if the protection or the load check functions is activated.

Typical loads are solenoids, relays or resistive loads.

The PBD 3548/1 and PBD 3545/1 are complementary drivers and have similar data.

Key features

- 2 A continuous-output current
- Short circuit to ground protection
- Error signal to host system
- Open circuit detection
- Short circuit to V_{CC} detection
- Thermal protection
- Built-in protection diodes
- LS-TTL, CMOS, and supply voltage compatible input
- ESD protected
- 5-pin TO-220 package, or 28-lead power PLCC with lead-frame for heat-sinking through PC board copper.

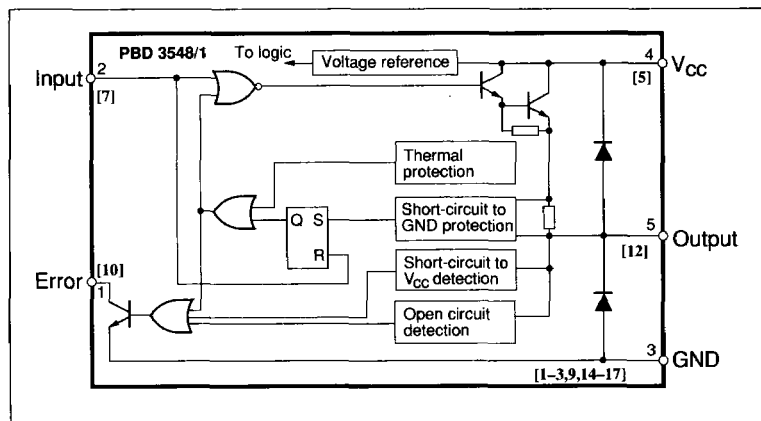
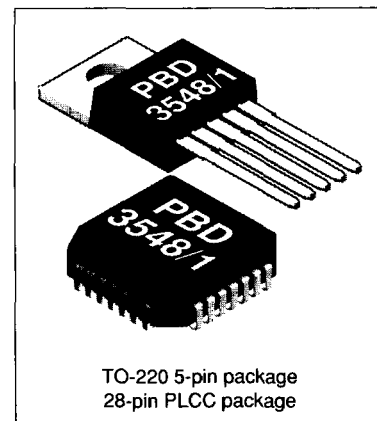

Figure 1. Block Diagram. Pin number in brackets refer to PLCC package.



Maximum Ratings

Parameter	Pin no.* (note 1)	Symbol	Min	Max	Unit
Voltage					
Supply voltage	1 [21]	V_{CC}	0	45	V
Logic input voltage	5 [5]	V_{In}	-0.3	V_{CC}	V
Current					
Logic input current	5 [5]	I_{In}	-10		mA
Continuous DC Operation output current	2 [24]	I_{Out}	-2		A
Error output current	4 [7]	I_{Err}		10	mA
Temperature					
Operating junction temperature (internally limited)		T_J		+140	°C
Storage temperature		T_{Stg}	-55	+150	°C
Power Dissipation (Package Data)					
Power dissipation at $T_{Case} = 85^\circ\text{C}$, TO-220 package		P_D		11	W
Power dissipation at $T_{Case} = 85^\circ\text{C}$, PLCC package		P_D		5	W
ESD					
ESD tolerance (Note 2)				2000	V

Recommended Operating Conditions

Parameter	Symbol	Min	Typ	Max	Unit
Supply voltage	V_{CC}	4.75		40	V
Output current	I_{Out}	-2			A
Operating ambient temperature	T_{Amb}	-40		+85	°C
Error output current	I_{Err}		5	8	mA

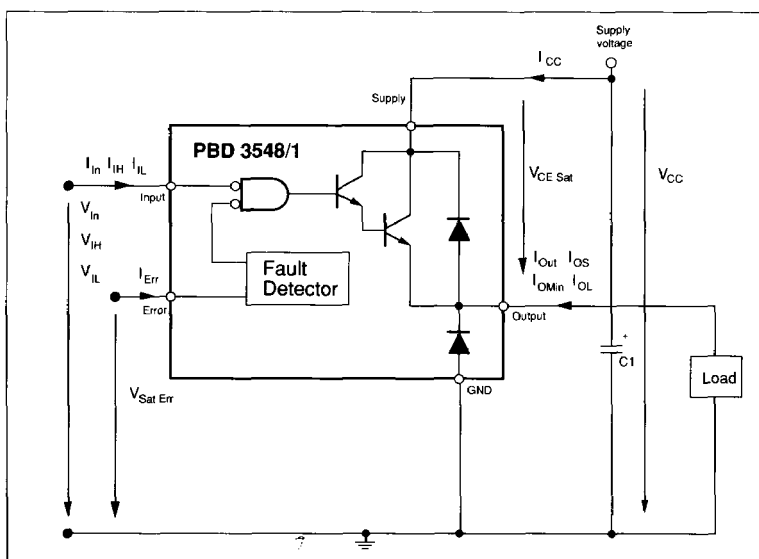

Figure 2. Definition of symbols.

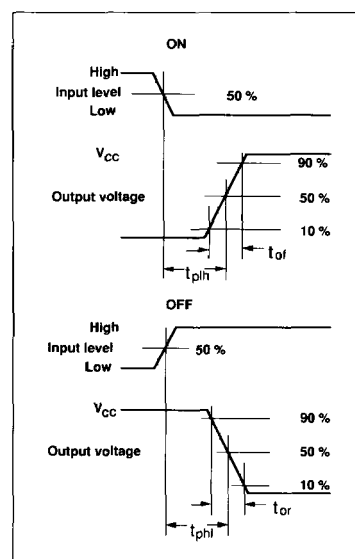

Figure 3. Timing diagram, input vs. output. $V_{CC} = 24V$.

Electrical Characteristics

At $5\text{ V} \leq V_{CC} \leq 40\text{ V}$, $-40^\circ\text{C} \leq T_J \leq +100^\circ\text{C}$. Typical values are given at $V_{CC} = 24\text{ V}$, $T_J = 25^\circ\text{C}$.

Parameter	Symbol	Ref. fig.	Conditions	Min	Typ	Max	Unit
General							
Supply current	I_{CC}	2,7	$2.0 \leq V_{IN} \leq V_{CC}$	1.5	4	7	mA
Thermal shutdown	T_{JS}			+120	+130	+140	$^\circ\text{C}$
Thermal shutdown release	T_{JSR}			+110	+120	+130	$^\circ\text{C}$
Logic input							
High level input voltage	V_{IH}	2		2.0		V_{CC}	V
Low level input voltage	V_{IL}	2		-0.3		0.8	V
High level input current	I_{IH}	2,9	$2.0 \leq V_{IN} \leq V_{CC}$			20	μA
Low level input current	I_{IL}	2,9	$0 \leq V_{IN} \leq 0.8$	-400	-4		μA
Outputs							
Error output saturation voltage	V_{ErrSAT}	2,10	$I_{Err} = 5\text{ mA}$		0.2	1	V
Output saturation voltage	V_{CESAT}	2,11	$i_{OUT} = -2\text{ A}$		1.9	2.4	V
Output current shutdown	I_{OS}	2,5,14	$0 \leq V_{IN} \leq 0.8\text{ V}$	-5.0	-3.5	-2.0	A
Output current (not detected as open circuit)	I_{OMIN}	2,5	$0 \leq V_{IN} \leq 0.8\text{ V}$	-8	-3	-1	mA
Output leakage current	I_{OL}	2,12	$2.0 \leq V_{IN} \leq V_{CC}$, Output = V_{CC}	-2	-6	-8	μA
Clamping diode forward voltage		8	$I_F = 2.0\text{ A}$		1.5	1.8	V
Timing							
Propagation time		3	$I_{OUT} = -2\text{ A}$				
Output low to high (50%),	t_{pLH}				0.6	1.0	μs
Output high to low (50%),	t_{pHL}				0.5	1.0	μs
Rise time (10 to 90%),	t_{or}	3			0.6	1.0	μs
Fall time (90 to 10%),	t_{of}	3			0.2	0.4	μs

Thermal Characteristics

Parameter	Symbol	Ref. fig.	Conditions	Min	Typ	Max	Unit
Thermal resistance	$R_{th\ J-C}$	21	TO-220 package, junction to case		5		$^\circ\text{C/W}$
	$R_{th\ J-A}$	21	TO-220 package, junction to ambient		60		$^\circ\text{C/W}$
	$R_{th\ J-BW}$	20	PLCC package, junction to batwing		10		$^\circ\text{C/W}$
	$R_{th\ J-A}$	20,22	PLCC package. Note 3.		35		$^\circ\text{C/W}$

- Notes: 1. Currents are defined positive if flowing into, and negative if flowing out of a terminal. Voltages are defined between terminal and ground.
 2. ESD testing according to Human Body Model ($C_{zap} = 100\text{ pF}$, $R_{zap} = 1500\ \Omega$)
 3. All ground pins soldered onto a 20 cm^2 PCB copper area with free air convection, $T_A = +25^\circ\text{C}$.

Pin Description

TO-220	PLCC	Symbol	Description
1	[5]	Error	Error indicating pin. Sinks current to ground if the protection and/or detection circuitry is activated. Note: the current must be externally limited to 8 mA.
2	[7]	Input	TTL compatible input. A HIGH input signal turns the output transistor off and a LOW input turns it on. If the input is left open it will be detected as high level.
3	[1-3,9 13-17, 28]	GND	Ground supply. Note: for PLCC these pins are used thermally for heat sinking. Make sure that all pins are soldered onto a suitably large copper ground for efficient heat sinking.
4	[10]	Supply	Supply voltage. Nominally 5 V to 40 V.
5	[12]	Output	Output pin. Current flows out from this pin through the load to GND. Nominal current is 8 mA to 2 A.
		NC	No connection. Pins are not bonded to the chip and may therefore be soldered to any PC board trace for efficient heat sinking.
		[4,6,8,11, 18-27]	

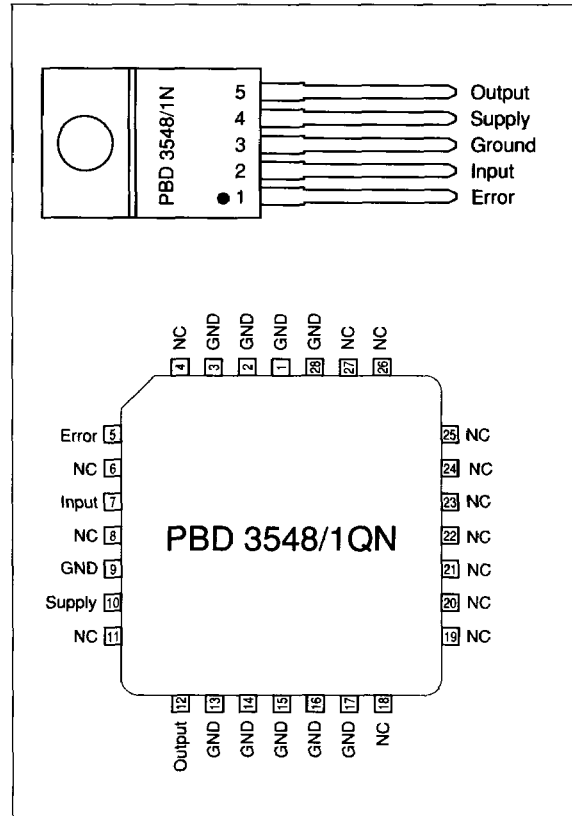

Figure 4. Pin descriptions.

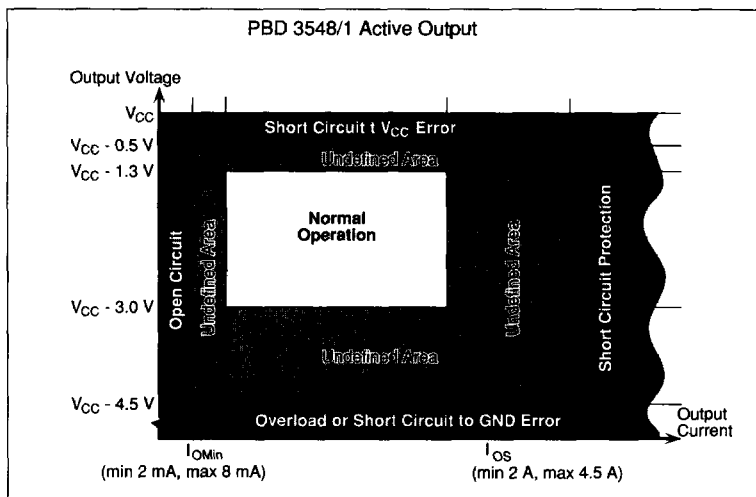

Figure 5. Error state vs. output voltage and output current, active output ($0V \leq V_{IN} \leq 0.8V$, $5V < V_{CC} < 40V$ and $-40^\circ C < T_J < +100^\circ C$)

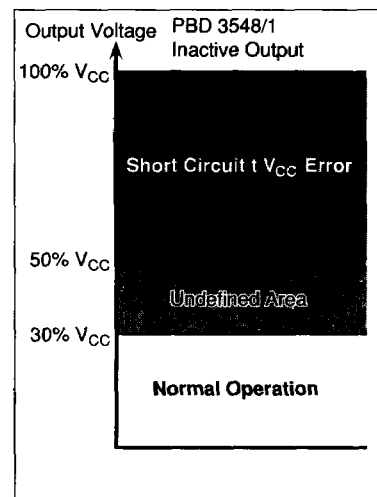

Figure 6. Error state vs. output voltage, inactive output ($2.0V \leq V_{IN} \leq V_{CC}$, $5V \leq V_{CC} \leq 40V$ and $-40^\circ C < T_J < +100^\circ C$).

Typical performance characteristics

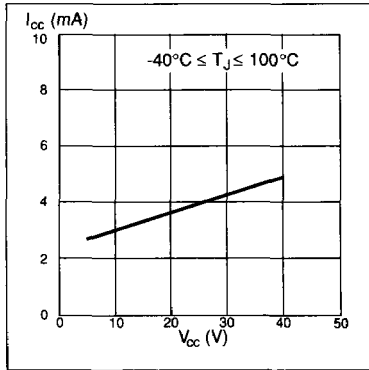

Figure 7. Current consumption vs. supply voltage at $2\text{ V} \leq V_{in} \leq V_{cc}$.

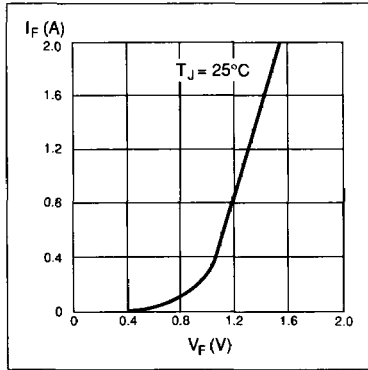

Figure 8. Diode forward voltage drop vs. forward current.

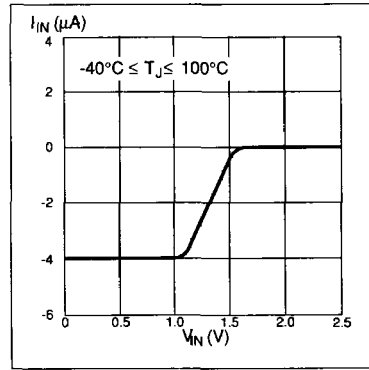

Figure 9. Input current vs. input voltage. $5\text{ V} \leq V_{cc} \leq 40\text{ V}$.

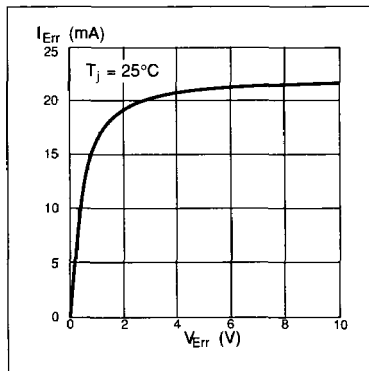

Figure 10. Error output saturation voltage vs. error current. $V_{cc} = 24\text{ V}$.

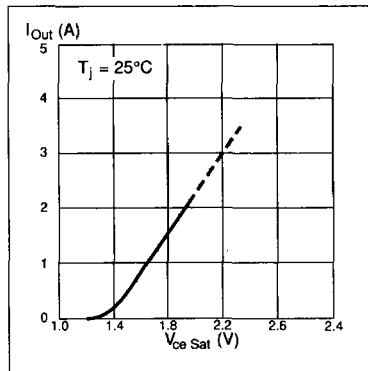

Figure 11. Output saturation voltage vs. output current. $5\text{ V} < V_{cc} < 40\text{ V}$.

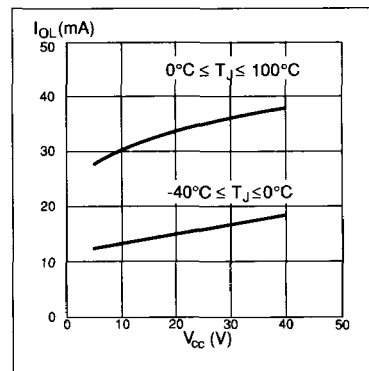

Figure 12. Output leakage current vs. supply voltage. $2.0\text{ V} \leq V_{in} \leq V_{cc}$. Output = V_{cc} .

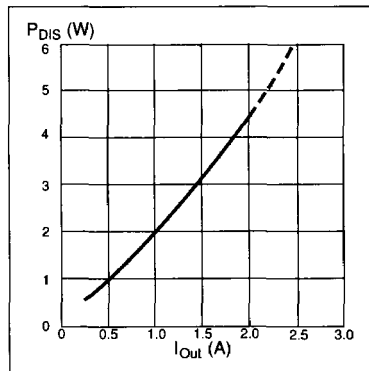

Figure 13. Power dissipation vs. output current.

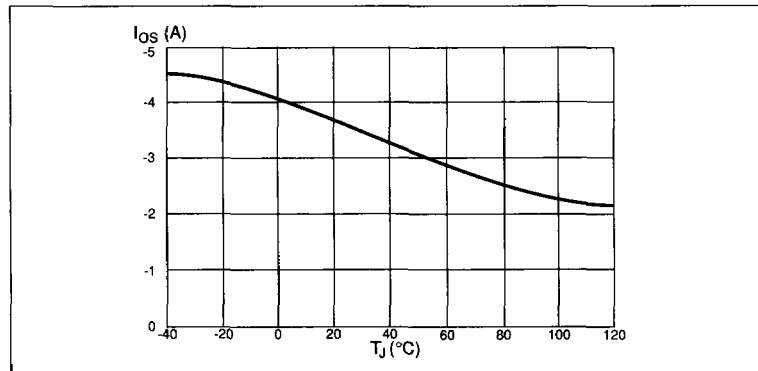

Figure 14. Output current shut-down vs. chip temperature. $5\text{ V} \leq V_{cc} \leq 40\text{ V}$.

Functional Description

The circuit PBD 3548/1 is a high side driver capable of driving resistive or inductive loads not exceeding 2 A.

The driver has an error indicating function which generates an Error output signal when a fault condition has occurred.

The circuits PBD 3548/1 and PBD 3545/1 are complementary drivers with equivalent functions and similar data. PBD 3548/1 is a source driver and PDB 3545/1 is a sink driver.

Input stage

The output stage is switched on and off according to the status of the input. LOW level activates the output. If the input is left open, the circuit will accept it as a HIGH level.

Output stage

The output stage contains a power transistor and two clamping diodes. The diodes are used for terminating line

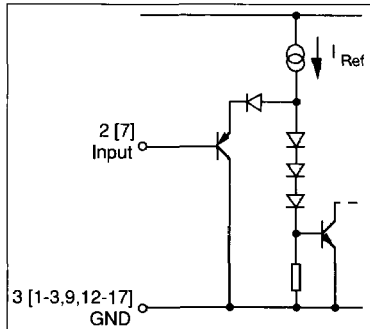

Figure 15. Input stage.

transients from inductive loads. If the driver is inactive and the output is shorted to V_{CC} the driver will leak a maximum of 40 mA. See figure 12.

Protection circuitry

The circuit contains two protection circuits:

- Overload and Short circuit protection
- Thermal protection

The overload and short circuit protection will be activated at $I_{out} = 3.5$ A typically at $T_j = +25^\circ\text{C}$, see figure 14.

The output will be turned off immediately and latched to a high-impedance state after an overload or short circuit has been detected.

A logic-level change at the input will reset the internal error latch. If the fault still is present at turn-on, the circuit will once again turn the output off.

Due to a slight delay in the circuit, a high current transient will occur when the output is shorted to GND. This current transient may reach 8 A during 5 μs .

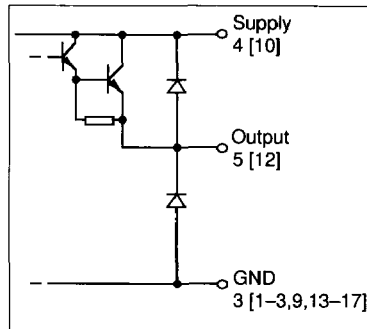

Figure 16. Output stage.

Consequently, switching at high frequencies with a shorted output may destroy the circuit. If a short circuit condition is detected, stop switching the input and remove fault condition.

Thermal protection

The output of PDB 3548/1 is equipped with a thermal shut-down function, which limits the junction temperature to typically $+130^\circ\text{C}$. The output will be turned off until the junction temperature has decreased to approximately 120°C .

Error functions

The Error indicating signal occurs on a separate pin. The complete error table is shown in figure 17.

The following conditions generate an error signal:

When the driver is activated and at least one of the following conditions has occurred:

- thermal overload
- short circuit to GND
- short circuit to V_{CC}
- open circuit

An output current less than 8 mA might be detected as "open circuit". Output currents larger than 8 mA and less than 2 A will definitely not generate an error. The normal operational area is shown in figure 5.

Also when the driver is inactivated an Error indication can occur. That is if the output is shorted to V_{CC} . In figure 6 short circuit to V_{CC} Error state versus output voltage is shown.

Fault condition	Input	Output	Error LOW=ERROR HIGH=Normal	How to resume normal operation
Normal	0 LOW 1 HIGH	1 ON 0 OFF	1 HIGH 1 HIGH	— —
V_{OUT} Short to V_{CC}	0 LOW 1 HIGH	1 ON 0 OFF	0 LOW 0 LOW	Remove fault condition. Remove fault condition.
V_{OUT} Short to GND	0 LOW 1 HIGH	0 OFF 0 OFF	0 LOW 1 HIGH	Turn off and on after fault condition is removed. —
Open load	0 LOW 1 HIGH	1 ON 0 OFF	0 LOW 1 HIGH	Attach proper load to output or turn off the driver. —
Over temperature $T_j = 130^\circ\text{C}$	0 LOW 1 HIGH	0 OFF 0 OFF	0 LOW 1 HIGH	Temperature is reduced to approx 120°C , or turn off the driver. —

Figure 17. Error table.

When the Error-detection function is activated, the Error output is capable of sinking 8 mA, supporting direct connection of an LED. The current has to be externally limited by a series resistor.

Signal diagrams

The signal diagram in figure 18 shows the input signal and the resulting output signals for each error mode. For details, see error table, figure 17.

- V_{in} = Input voltage. Active = LOW.
- V_{out} = Output voltage.
- I_{out} = Output current from driver.
- V_{err} = Error output voltage. Error = LOW.

Applications Information

Important application areas are:

- Programmable logic control systems.
- Security systems.
- Relay control.
- Hydraulic valves.
- Intelligent interfaces between micro-processors and loads.
- Vehicle control systems.
- Robot techniques.
- Dashboard information systems.
- Print head drivers.
- High-current stepper motor drivers with security aspects.

Transient protection

1. Keep V_{cc} and GND leads as short as possible. Use different supplies if possible.
2. Connect a filter capacitor close to the circuit. Recommended filter capacitor between V_{cc} and GND is 6.8 μ F, of tantalum type. A ceramic capacitor in parallel will improve high frequency decoupling. Typical values range from 0.002 μ F to 0.1 μ F. In an application having a highly stable supply and short power leads to the driver a low leakage electrolytic type can be used, which is less expensive.
3. Connect Input and Error via pull-up resistors to the appropriate logic supply level or V_{cc} to obtain highest noise immunity. See figure 19. The resistor R_1 limits the current into the Error indicator pin. This current must not exceed 8 mA. R_2 is a pull-up resistor which improves noise immunity at the Input. Pull-up current should not exceed the sinking capacity of the controlling device output.

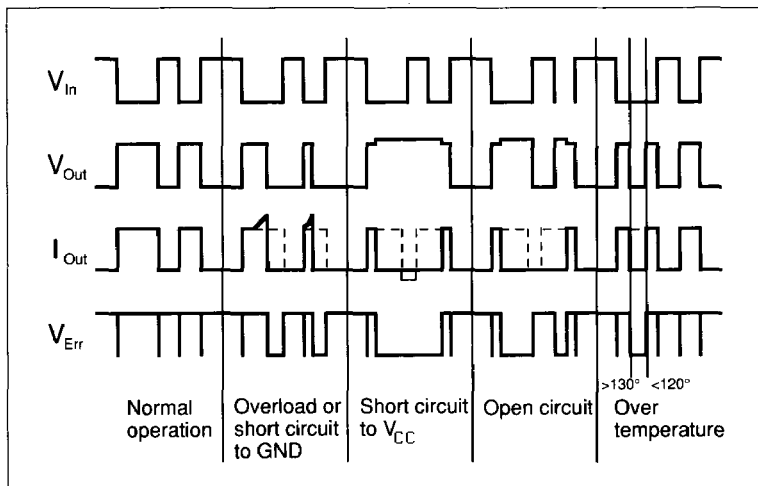

Figure 18. Signal diagram

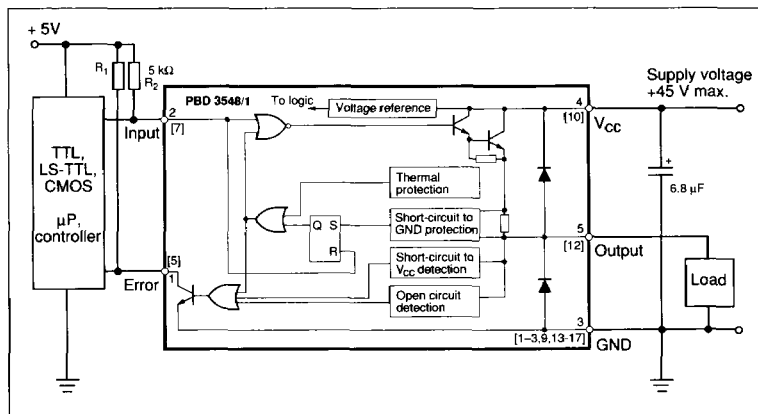

Figure 19. Typical application. Pin numbers refer to TO 220 package.

ing pin. This current must not exceed 8 mA. R_2 is a pull-up resistor which improves noise immunity at the Input. Pull-up current should not exceed the sinking capacity of the controlling device output.

4. If several supply voltages are to be used, prefer a supply having separate ground leads. In this case the logic ground and the power ground should be connected together at only one point, the ground pin of the driver.

Switch mode applications

The internal diodes are normally sufficient for clamping of transients caused by inductive load turn off. External diodes may be necessary in PWM/switch

mode applications, and when the terminals are externally accessible and thereby exposed to an electrically noisy environment. Recommended diodes are BYV27/100, BYV98/100, UF4001 or similar types with a $t_r < 100$ ns and $I_F \geq 1$ A.

Error indication signal

When the circuit is switched on/off, a short pulse ($t_{err} < 10 \mu$ S for resistive loads) is generated at the Error output. This is a correct detection of an incorrect level during the rise and fall times of the output voltage. Consequently the Error output should not be detected when switching on and off. An alternative is to low-pass filter at the Error output at around 100 kHz.

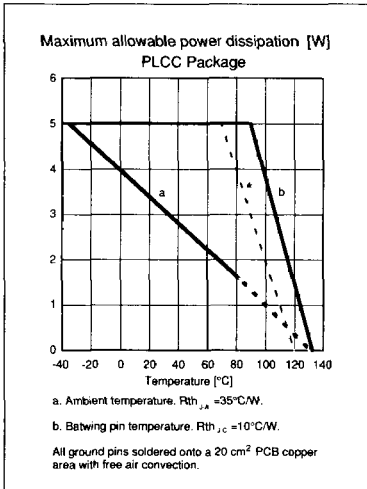

Figure 20. Maximum allowable power dissipation. PLCC package.

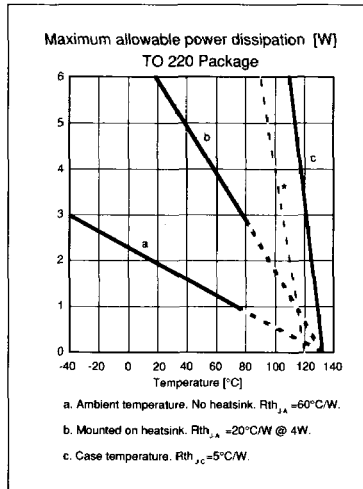

Figure 21. Maximum allowable power dissipation. TO 220 package.

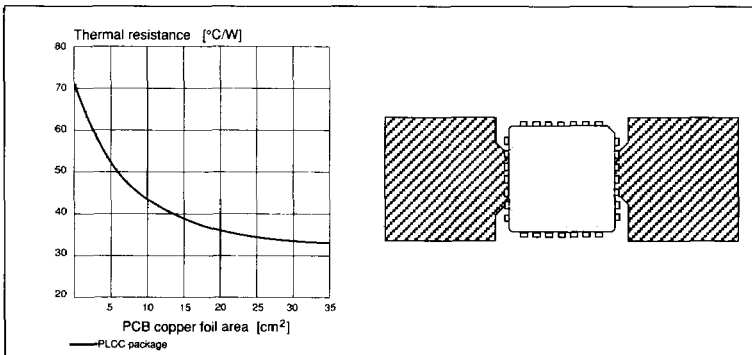

Figure 22. Typical thermal resistance vs. PC board copper area and suggested layout.

Information given in this data sheet is believed to be accurate and reliable. However no responsibility is assumed for the consequences of its use nor for any infringement of patents or other rights of third parties which may result from its use. No license is granted by implication or otherwise under any patent or patent rights of Ericsson Components. These products are sold only according to Ericsson Components' general conditions of sale, unless otherwise confirmed in writing.

Specifications subject to change without notice.

IC4 (88082) A-Ue
© Ericsson Components 1988
Revised edition May 1991



Ericsson Components AB
S-164 81 Kista-Stockholm, Sweden
Telephone: (08) 757 50 00

Heat sinking

PBD 3548/1N is packaged in a 5-pin TO 220 power package. The circuit GND is connected to the heat sink tab. External heatsinking is achieved by mounting the package to a heat sink.

The circuit is also available in a 28 pin power PLCC package. In the PLCC package the circuit ground is connected to the lead frame batwing. External heatsinking is achieved by soldering the ground leads onto a copper ground plane. Note: The power ground pin (PWR GND) should also be connected to the ground plane.

Maximum continuous output current is heavily dependent on the heatsinking applied and ambient temperature. Consult figures 13, 20, 21 and 22 to determine the maximum output current under varying conditions.

Ordering Information

Package	Temp. range	Part No.
TO-220	-40 to +85°C	PBD 3548/1N
PLCC	-40 to +85°C	PBD 3548/1QN

T-90-20

5-lead TO-220

dim.	millimeters		inches	
	min.	max.	min.	max.
A	3.53	3.91	0.139	0.154
B	9.66	10.66	0.380	0.420
C	3.55	4.80	0.140	0.189
D	1.05	1.39	0.041	0.055
E	2.04	2.92	0.080	0.155
F	0.38	0.50	0.015	0.020
G	2.54	3.05	0.100	0.120
H		3.00		0.118
I	1.50	1.90	0.059	0.075
J	12.50	14.50	0.492	0.571
K	14.32	15.52	0.564	0.611
L	0.81	0.95	0.032	0.037
M	5.85	6.85	0.230	0.270

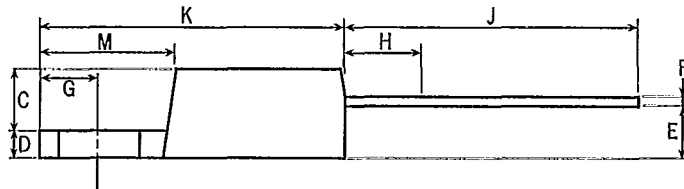
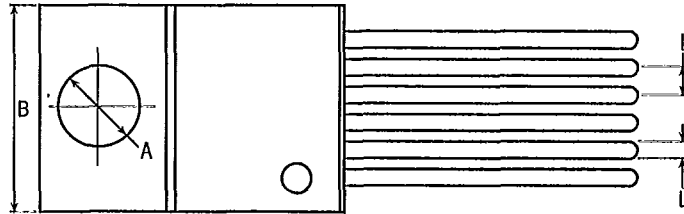
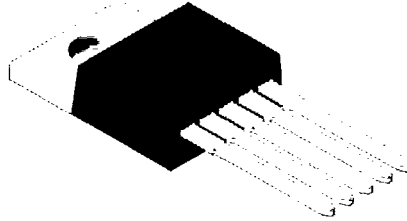

16-lead small outline package

dim.	millimeters		inches	
	min.	max.	min.	max.
A	2.35	2.65	0.093	0.104
B	0.33	0.51	0.013	0.020
C	0.23	0.32	0.009	0.012
D	1.27 typical		0.050 typical	
E	7.40	7.60	0.291	0.299
F	10.00	10.65	0.394	0.419
G	0.40	1.27	0.016	0.050
H	10.10	10.50	0.397	0.460
I	0.66		0.026	

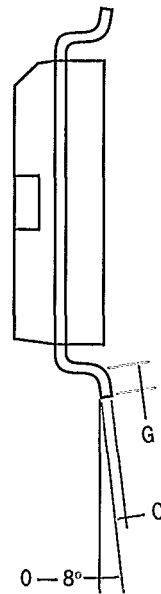
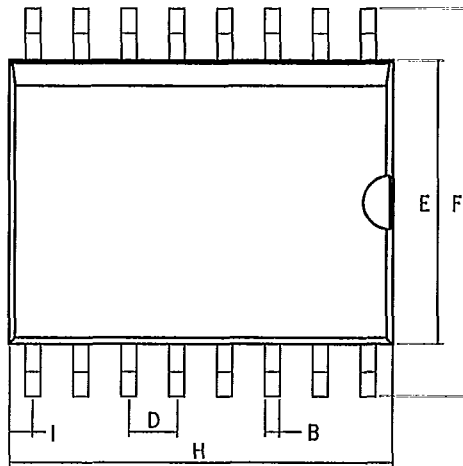
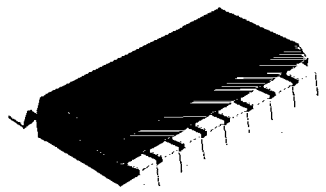

16-pin dual in-line package

dim.	millimeters		inches	
	min.	max.	min.	max.
A	0.39		0.015	
B	0.13		0.005	
C	0.36	0.56	0.014	0.022
D	2.54 typical		0.100 typical	
E		5.33		0.210
F	2.93	4.06	0.115	0.160
G	7.62	8.25	0.300	0.325
H	0.20	0.38	0.008	0.015
I	18.93	21.33	0.745	0.840
J	6.10	7.11	0.240	0.280
K	2.93	4.95	0.115	0.195
L		10.92		0.430
M	1.15	1.77	0.045	0.070

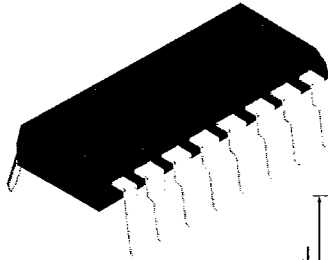

T-90-20

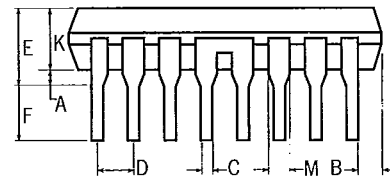
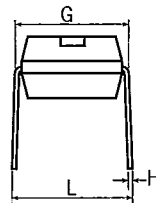
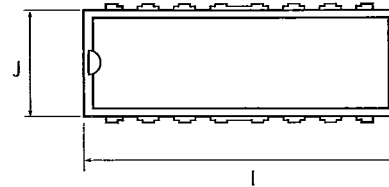
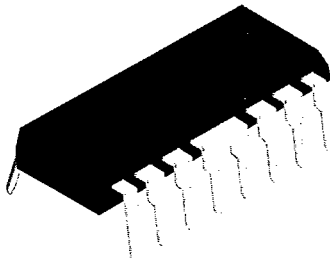
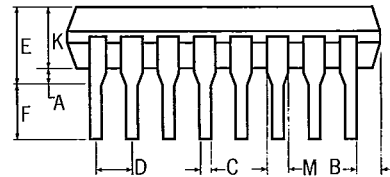
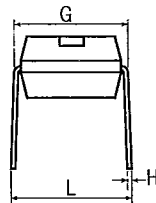
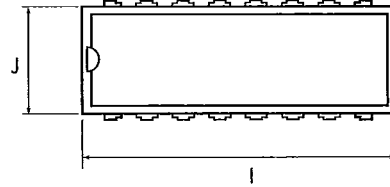

22-pin dual in-line package

T-90-20

dim.	millimeters		inches	
	min.	max.	min.	max.
A	0.39		0.015	
B	0.13		0.005	
C	0.36	0.56	0.014	0.022
D	2.54	typical	0.100	typical
E		5.33		0.210
F	2.93	4.06	0.115	0.160
G	9.91	10.79	0.390	0.425
H	0.20	0.38	0.008	0.015
I	26.67	28.44	1.050	1.120
J	8.39	9.65	0.330	0.380
K	3.18	4.95	0.125	0.195
L		12.70		0.500
M	0.77	1.77	0.030	0.070
N	0.56	1.17	0.022	0.046

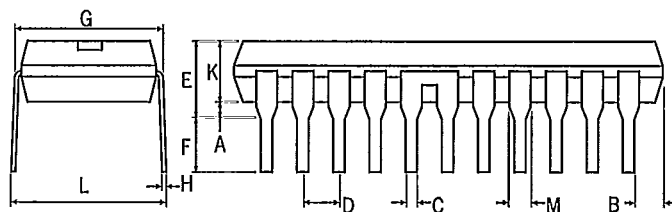
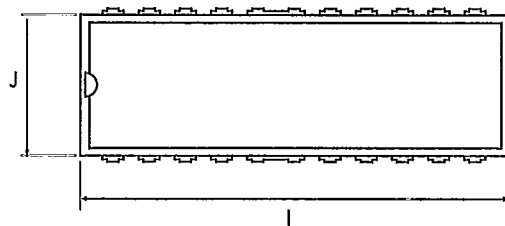
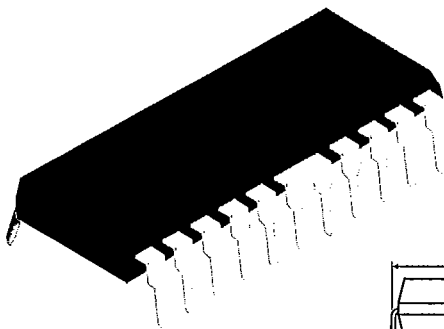
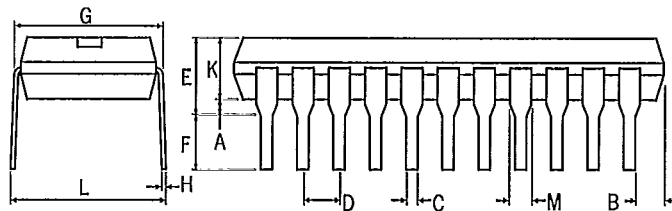
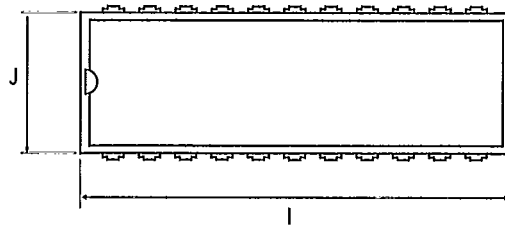
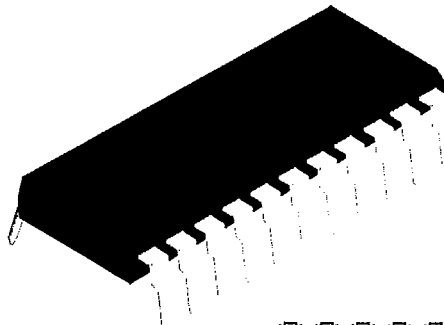

T-90-20

24-pin dual in-line package

dim.	millimeters		inches	
	min.	max.	min.	max.
A	0.39		0.015	
B	0.13		0.005	
C	0.36	0.56	0.014	0.022
D	2.54 typical		0.100 typical	
E		5.33		0.210
F	2.93	4.06	0.115	0.160
G	7.62	8.25	0.300	0.325
H	0.20	0.38	0.008	0.015
I	28.60	32.30	1.125	1.275
J	6.10	7.11	0.240	0.280
K	2.93	4.95	0.115	0.195
L		10.92		0.430
M	1.15	1.77	0.045	0.070

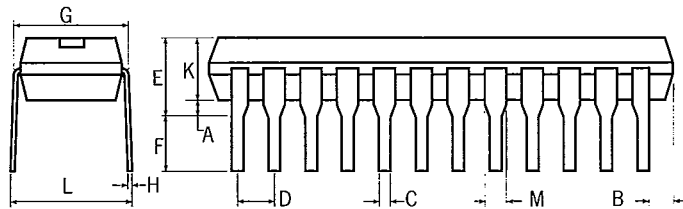
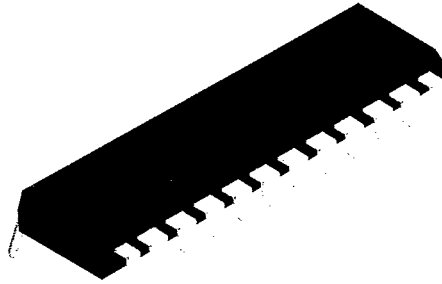

28-lead PLCC package

dim.	millimeters		inches	
	min.	max.	min.	max.
A	12.32	12.57	0.485	0.495
B	11.43	11.58	0.450	0.456
C	0.66	0.81	0.026	0.032
D	2.29	3.04	0.090	0.120
E	9.91	10.92	0.390	0.430
F	4.20	4.57	0.165	0.180
G	1.27 typical		0.050 typical	
I	0.51		0.020	
J	0.33	0.53	0.013	0.027

