

SINGLE-ENDED ANALOG-INPUT 20-BIT STEREO ANALOG-TO-DIGITAL CONVERTER

FEATURES

- Dual 20-Bit Monolithic $\Delta\Sigma$ ADC
- Single-Ended Voltage Input
- 64x Oversampling Decimation Filter:
 - Pass-Band Ripple: ± 0.05 dB
 - Stop-Band Attenuation: -65 dB
- High Performance:
 - THD+N: -88 dB (typical)
 - SNR: 95 dB (typical)
 - Dynamic Range: 95 dB (typical)
 - Internal High-Pass Filter
- PCM Audio Interface:
 - Master/Slave Modes
 - Four Data Formats
- Sampling Rate: 4 kHz to 48 kHz
- System Clock: 256 f_s , 384 f_s , or 512 f_s
- Single 5-V Power Supply
- Small 24-Pin SSOP Package

APPLICATIONS

- DVD Recorders
- DVD Receivers
- AV Amplifier Receivers
- Electric Musical Instruments

DESCRIPTION

The PCM1800 is a low-cost, single-chip stereo analog-to-digital converter (ADC) with single-ended analog voltage inputs. The PCM1800 uses a delta-sigma modulator with 64 times oversampling, including a digital decimation filter and a serial interface which supports both master and slave modes and four data formats. The PCM1800 is suitable for a wide variety of cost-sensitive consumer applications where good performance is required.

The PCM1800 is fabricated using a highly advanced CMOS process and is available in a small 24-pin SSOP package.

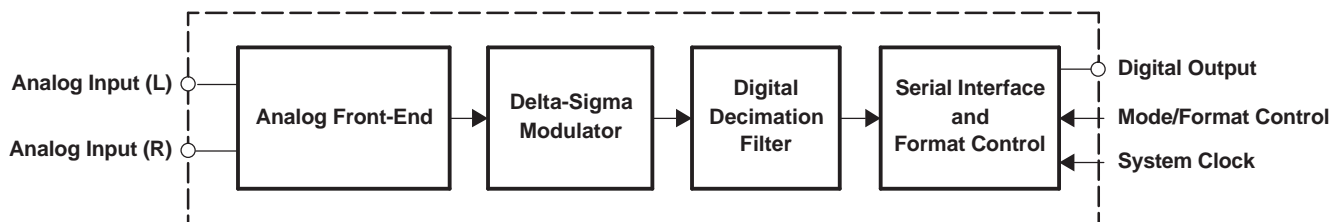

B0003-01



Please be aware that an important notice concerning availability, standard warranty, and use in critical applications of Texas Instruments semiconductor products and disclaimers thereto appears at the end of this data sheet.

System Two, Audio Precision are trademarks of Audio Precision, Inc.
All other trademarks are the property of their respective owners.



This integrated circuit can be damaged by ESD. Texas Instruments recommends that all integrated circuits be handled with appropriate precautions. Failure to observe proper handling and installation procedures can cause damage.

ESD damage can range from subtle performance degradation to complete device failure. Precision integrated circuits may be more susceptible to damage because very small parametric changes could cause the device not to meet its published specifications.

ELECTRICAL CHARACTERISTICS

All specifications at $T_A = 25^\circ\text{C}$, $V_{DD} = V_{CC} = 5\text{ V}$, slave mode, $f_S = 44.1\text{ kHz}$, 20-bit input data, and $\text{SYSCLK} = 384 f_S$, unless otherwise noted

PARAMETER		TEST CONDITIONS	PCM1800E			UNITS
			MIN	TYP	MAX	
RESOLUTION			20			Bits
DIGITAL INPUT/OUTPUT						
$V_{IH}^{(1)}$	Input logic level		2			VDC
$V_{IL}^{(1)}$					0.8	
$I_{IN}^{(2)}$	Input logic current				± 1	μA
$I_{IN}^{(3)}$					100	
$V_{OH}^{(4)}$	Output logic level	$I_{OH} = -1.6\text{ mA}$	4.5			VDC
$V_{OL}^{(4)}$		$I_{OL} = 3.2\text{ mA}$			0.5	
f_S	Sampling frequency		4	44.1	48	kHz
	System clock frequency	$256 f_S$	1.024	11.2896	12.288	MHz
		$384 f_S$	1.536	16.9344	18.432	
		$512 f_S$	2.048	22.5792	24.576	
DC ACCURACY						
	Gain mismatch, channel-to-channel			± 1	± 2.5	% of FSR
	Gain error			± 2	± 5	% of FSR
	Gain drift			± 20		ppm of FSR/ $^\circ\text{C}$
	Bipolar zero error	High-pass filter bypassed		± 2		% of FSR
	Bipolar zero drift	High-pass filter bypassed		± 20		ppm of FSR/ $^\circ\text{C}$
DYNAMIC PERFORMANCE⁽⁵⁾						
	THD+N at FS (-0.5 dB)			-88	-80	dB
	THD+N at -60 dB			-92		dB
	Dynamic range	A-weighted	90	95		dB
	Signal-to-noise ratio	A-weighted	90	95		dB
	Channel separation		88	93		dB
DYNAMIC PERFORMANCE⁽⁵⁾						
	Dynamic range	16-bit, A-weighted		94		dB
	Signal-to-noise ratio	16-bit, A-weighted		94		dB
	Channel separation	16-bit		92		dB
ANALOG INPUT						
	Input range	FS ($V_{IN} = 0\text{ dB}$)		2.828		Vp-p
	Center voltage			2.1		VDC
	Input impedance			30		k Ω
	Antialiasing filter frequency response	$C_{EXT} = 470\text{ pF}$, -3 dB		170		kHz
DIGITAL FILTER PERFORMANCE						

(1) Pins 6, 7, 8, 9, 10, 11, 16 and 12, 13, 14: RSTB, BYPAS, FMT0, FMT1, MODE0, MODE1, SYSCLK, and FSYNC, LRCK, BCK in slave mode

(2) Pins 16 and 12, 13, 14: SYSCLK and FSYNC, LRCK, BCK in slave mode (Schmitt-trigger input)

(3) Pins 6, 7, 8, 9, 10, 11: RSTB, BYPAS, FMT0, FMT1, MODE0, MODE1 (Schmitt-trigger input, with 100-k Ω typical pulldown resistor)

(4) Pins 15 and 12, 13, 14: DOUT and FSYNC, LRCK, BCK in master mode

(5) $f_{IN} = 1\text{ kHz}$, using the System Two™ audio measurement system by Audio Precision™, rms mode with 20-kHz LPF and 400-Hz HPF in the performance calculation.

ELECTRICAL CHARACTERISTICS (continued)

All specifications at $T_A = 25^\circ\text{C}$, $V_{DD} = V_{CC} = 5\text{ V}$, slave mode, $f_S = 44.1\text{ kHz}$, 20-bit input data, and $\text{SYSCLK} = 384 f_S$, unless otherwise noted

PARAMETER	TEST CONDITIONS	PCM1800E			UNITS	
		MIN	TYP	MAX		
Pass band				$0.454 f_S$	Hz	
Stop band		$0.583 f_S$			Hz	
Pass-band ripple				± 0.05	dB	
Stop-band attenuation		-65			dB	
Delay time (latency)			$17.4/f_S$		s	
High-pass frequency response	-3 dB		$0.019 f_S$		mHz	
POWER SUPPLY REQUIREMENTS						
V_{CC}	Voltage range		4.5	5	5.5	VDC
V_{DD}			4.5	5	5.5	
Supply current ⁽⁶⁾	$V_{CC} = V_{DD} = 5\text{ V}$		18	25	mA	
Power dissipation	$V_{CC} = V_{DD} = 5\text{ V}$		90	125	mW	
TEMPERATURE RANGE						
T_A	Operation		-25		85	$^\circ\text{C}$
T_{stg}	Storage		-55		125	$^\circ\text{C}$
θ_{JA}	Thermal resistance			100		$^\circ\text{C/W}$

(6) No load on DOUT (pin 15) in the slave mode

PIN CONFIGURATION

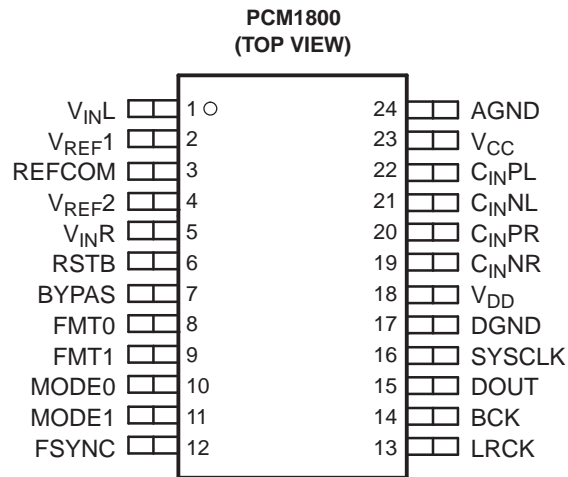

P0004-01

PIN ASSIGNMENTS

NAME	PIN	I/O	DESCRIPTION
AGND	24	–	Analog ground
BCK	14	I/O	Bit clock input/output
BYPAS	7	I	High-pass filter bypass control ⁽¹⁾
C _{IN} NL	21	–	Antialias filter capacitor (–), Lch
C _{IN} NR	19	–	Antialias filter capacitor (–), Rch
C _{IN} PL	22	–	Antialias filter capacitor (+), Lch
C _{IN} PR	20	–	Antialias filter capacitor (+), Rch
DGND	17	–	Digital ground
DOUT	15	O	Audio data output
FMT0	8	I	Audio data format 0 ⁽¹⁾
FMT1	9	I	Audio data format 1 ⁽¹⁾
FSYNC	12	I/O	Frame synchronization, input/output
LRCK	13	I/O	Sampling clock input/output (f _s)
MODE0	10	I	Master/slave mode selection 0 ⁽¹⁾
MODE1	11	I	Master/slave mode selection 1 ⁽¹⁾
REFCOM	3	–	Reference decoupling common
SYSCLK	16	I	System clock input, 256 f _s , 384 f _s , or 512 f _s
RSTB	6	I	Reset input, active LOW ⁽¹⁾
V _{CC}	23	–	Analog power supply
V _{DD}	18	–	Digital power supply
V _{IN} L	1	I	Analog input, Lch
V _{IN} R	5	I	Analog input, Rch
V _{REF} 1	2	–	Reference 1 decoupling capacitor
V _{REF} 2	4	–	Reference 2 decoupling capacitor

(1) With 100-kΩ typical pulldown resistor

PACKAGE/ORDERING INFORMATION

PRODUCT	PACKAGE TYPE	PACKAGE CODE	PACKAGE MARKING	ORDERING NUMBER	TRANSPORT MEDIA	QUANTITY
PCM1800E	24-pin SSOP	DB	PCM1800E	PCM1800E	Rails	58
				PCM1800E/2K	Tape and reel	2000

ABSOLUTE MAXIMUM RATINGS

Supply voltage: V_{DD} , V_{CC}	–0.3 V to 6.5 V
Supply voltage differences	±0.1 V
GND voltage differences	±0.1 V
Digital input voltage	–0.3 V to ($V_{DD} + 0.3$ V), < 6.5 V
Analog input voltage	–0.3 V to ($V_{CC} + 0.3$ V), < 6.5 V
Input current (any pin except supplies)	±10 mA
Power dissipation	300 mW
Operating temperature range	–25°C to 85°C
Storage temperature	–55°C to 125°C
Lead temperature, soldering	260°C, 5 s
Package temperature (IR reflow, peak)	235°C

RECOMMENDED OPERATING CONDITIONS

over operating free-air temperature range (unless otherwise noted)

	MIN	NOM	MAX	UNIT
Analog supply voltage, V_{CC}	4.5	5	5.5	V
Digital supply voltage, V_{DD}	4.5	5	5.5	V
Analog input voltage, full-scale (–0 dB)		2.828		V _{p-p}
Digital input logic family		TTL		
Digital input clock frequency	System clock	8.192	24.576	MHz
	Sampling clock	32	48	kHz
Digital output load capacitance		10		pF
Operating free-air temperature, T_A	–25		85	°C

BLOCK DIAGRAM

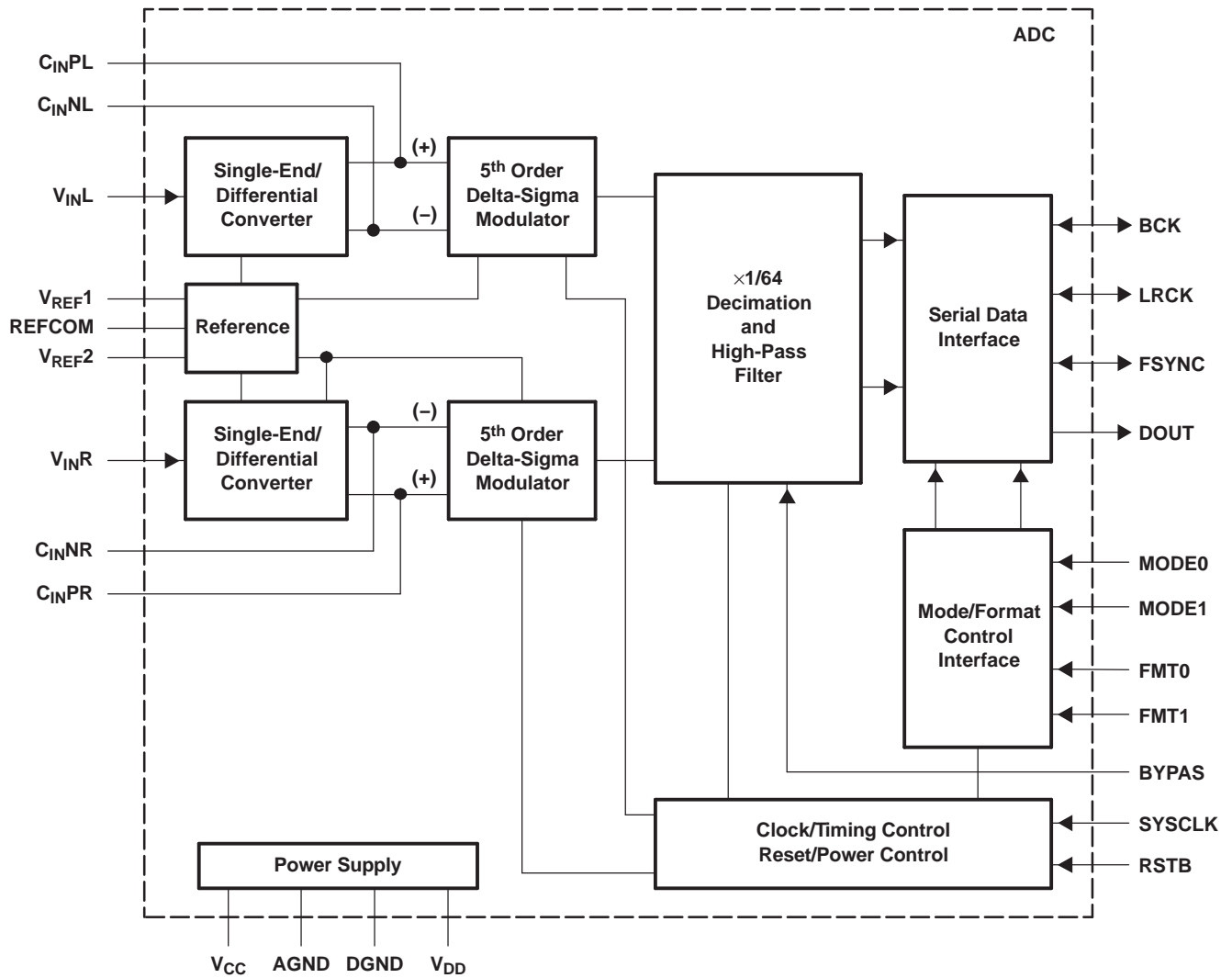

B0004-01

ANALOG FRONT-END (Single Channel)

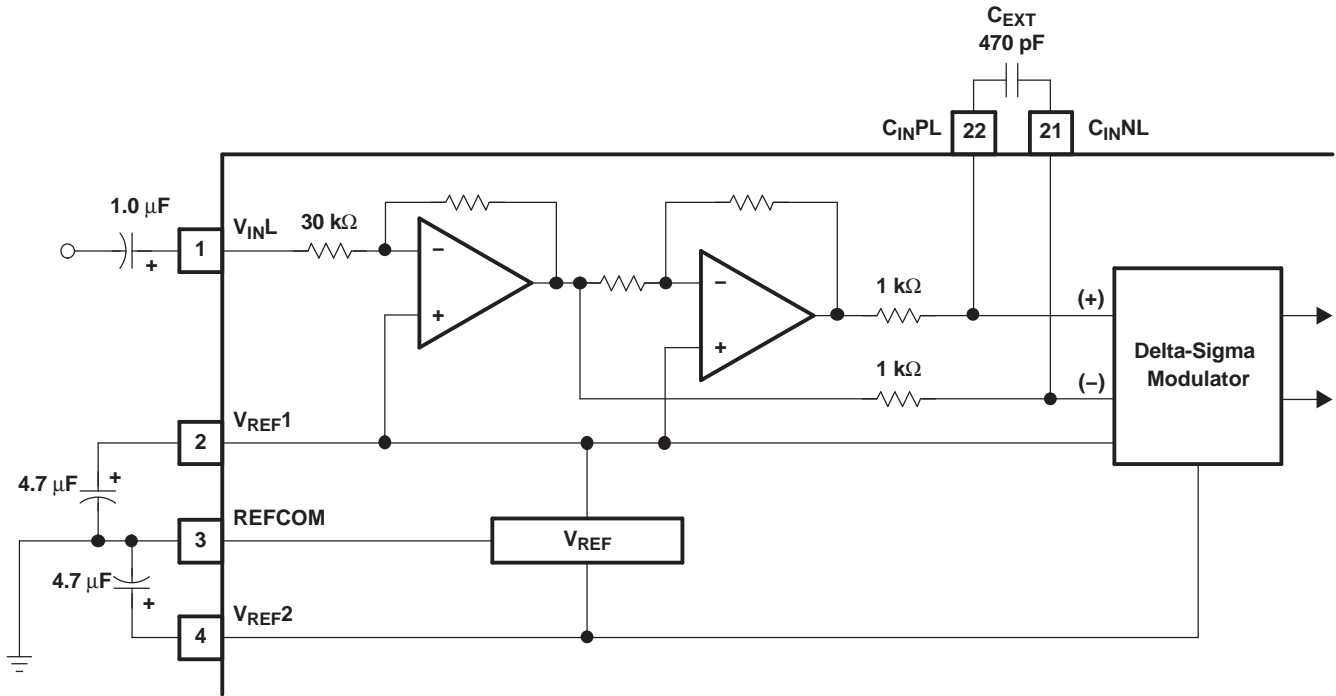

S0011-01

TYPICAL PERFORMANCE CURVES

All specifications at $T_A = 25^\circ\text{C}$, $V_{DD} = V_{CC} = 5\text{ V}$, slave mode, $f_s = 44.1\text{ kHz}$, 20-bit input data, and $\text{SYSCLK} = 384 f_s$, unless otherwise noted

THD+N vs TEMPERATURE

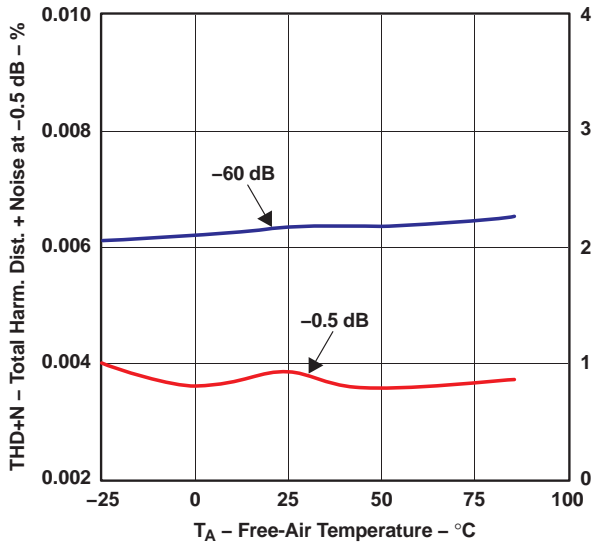

Figure 1.

DYNAMIC RANGE AND SNR vs TEMPERATURE

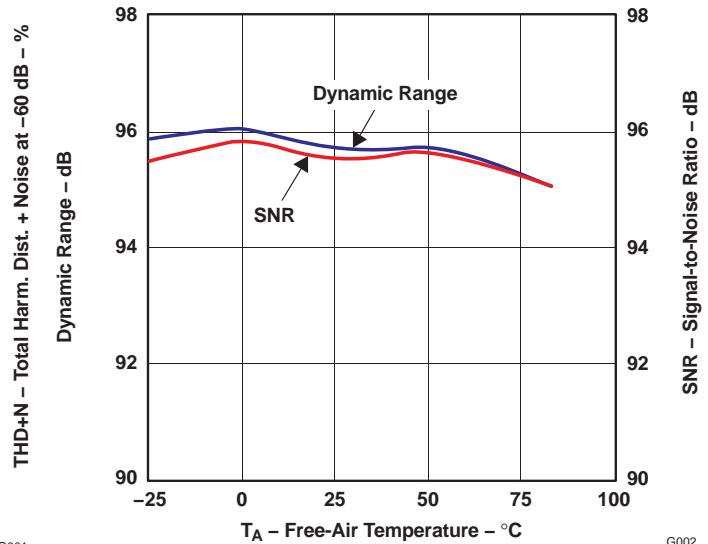

Figure 2.

TYPICAL PERFORMANCE CURVES (continued)

All specifications at $T_A = 25^\circ\text{C}$, $V_{DD} = V_{CC} = 5\text{ V}$, slave mode, $f_S = 44.1\text{ kHz}$, 20-bit input data, and $\text{SYSCLK} = 384 f_S$, unless otherwise noted

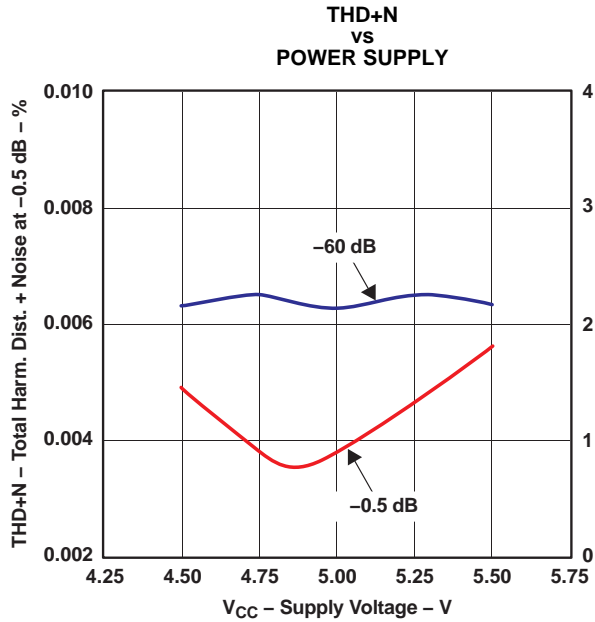

Figure 3.

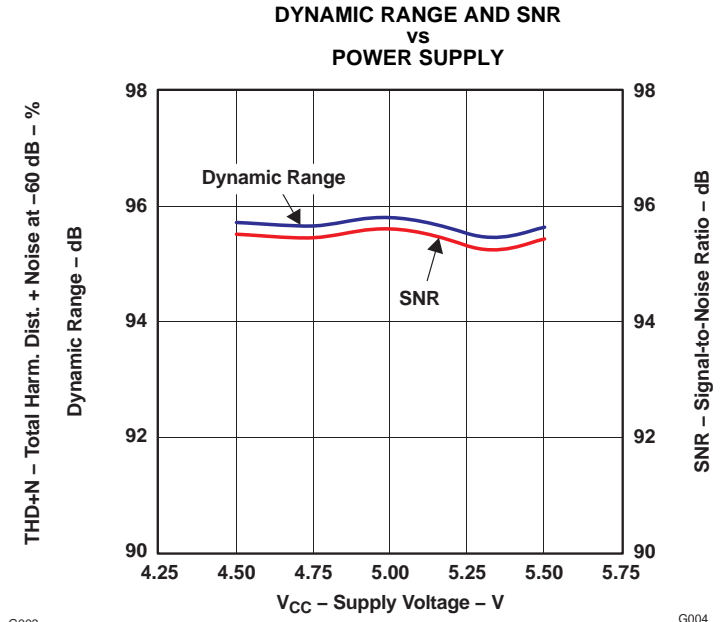

Figure 4.

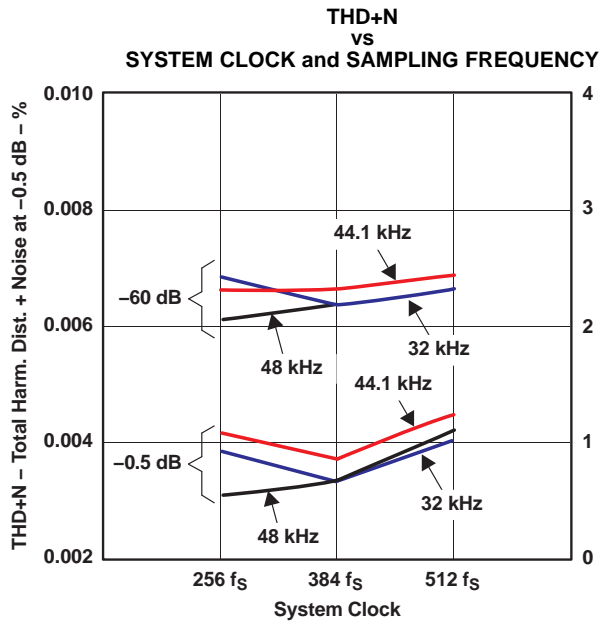

Figure 5.

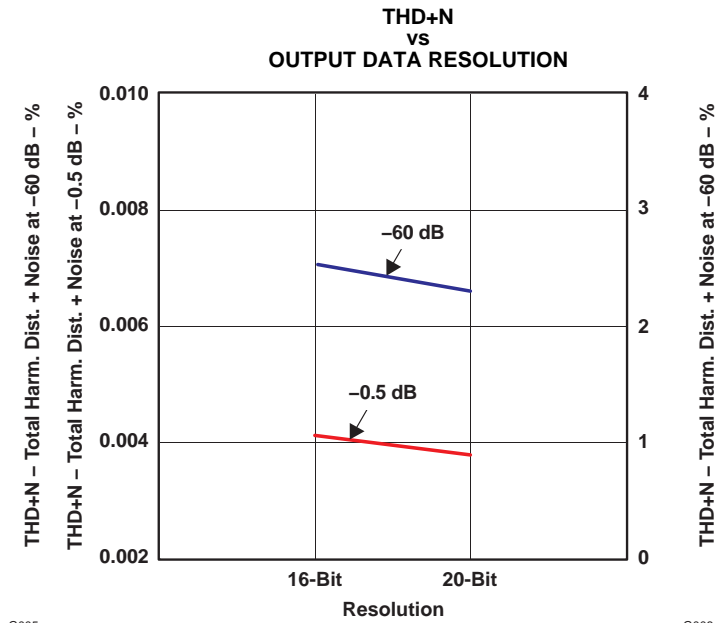

Figure 6.

TYPICAL PERFORMANCE CURVES (continued)

All specifications at $T_A = 25^\circ\text{C}$, $V_{DD} = V_{CC} = 5\text{ V}$, slave mode, $f_S = 44.1\text{ kHz}$, 20-bit input data, and $\text{SYSCLK} = 384 f_S$, unless otherwise noted

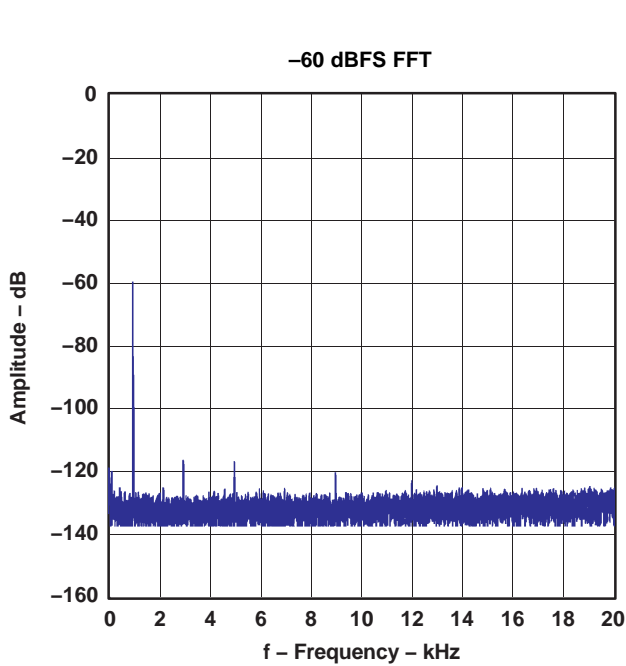

Figure 7.

G007

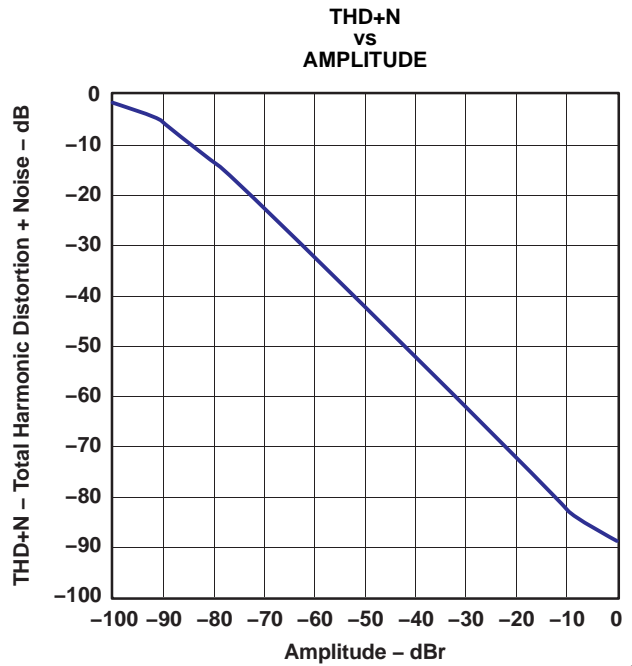

Figure 8.

G008

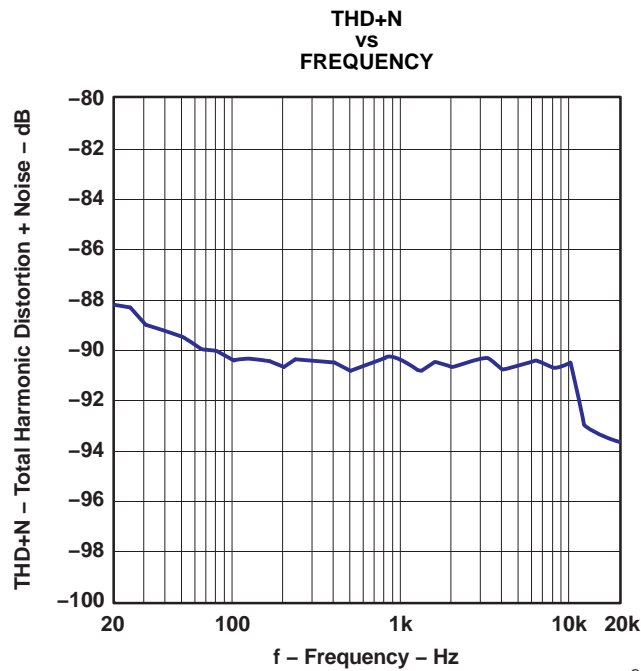

Figure 9.

G009

TYPICAL PERFORMANCE CURVES FOR INTERNAL FILTERS

All specifications at $T_A = 25^\circ\text{C}$, $V_{DD} = V_{CC} = 5\text{ V}$, slave mode, $f_S = 44.1\text{ kHz}$, 20-bit input data, and $\text{SYSCLK} = 384 f_S$, unless otherwise noted

DECIMATION FILTER

OVERALL CHARACTERISTICS

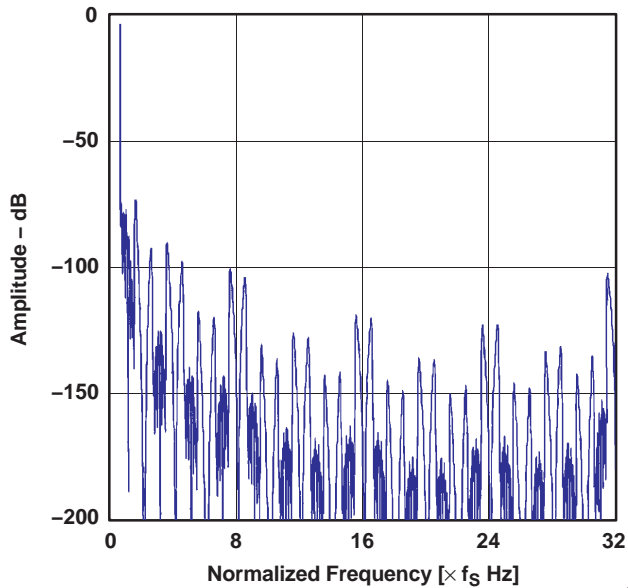

Figure 10.

STOP-BAND ATTENUATION CHARACTERISTICS

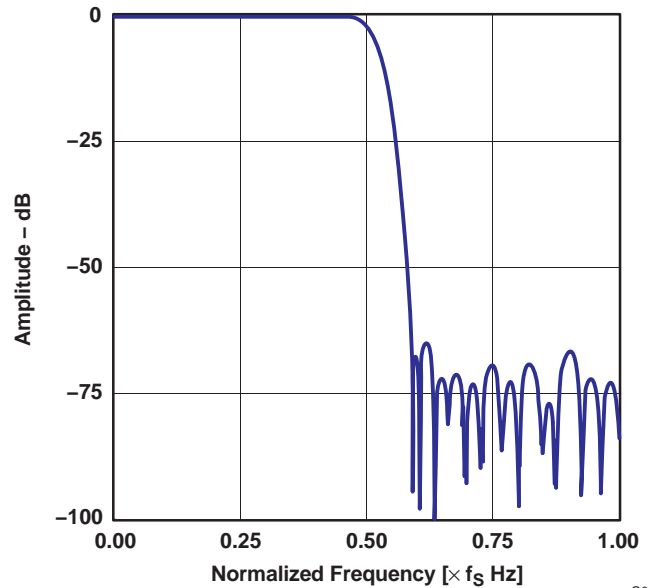

Figure 11.

PASS-BAND RIPPLE CHARACTERISTICS

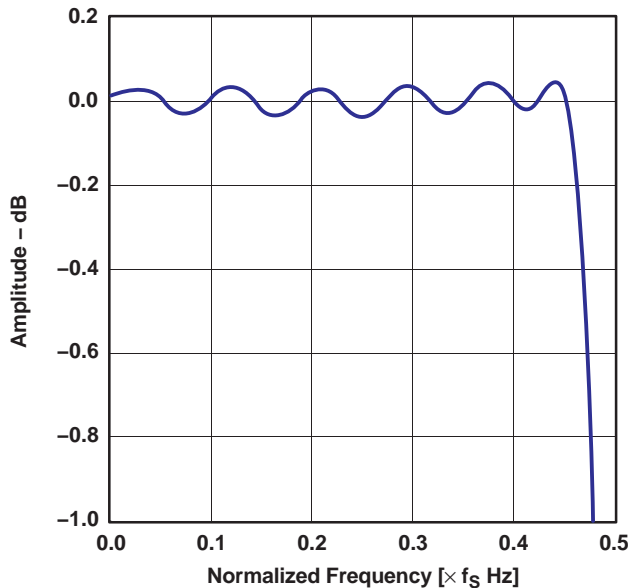

Figure 12.

TRANSITION BAND CHARACTERISTICS

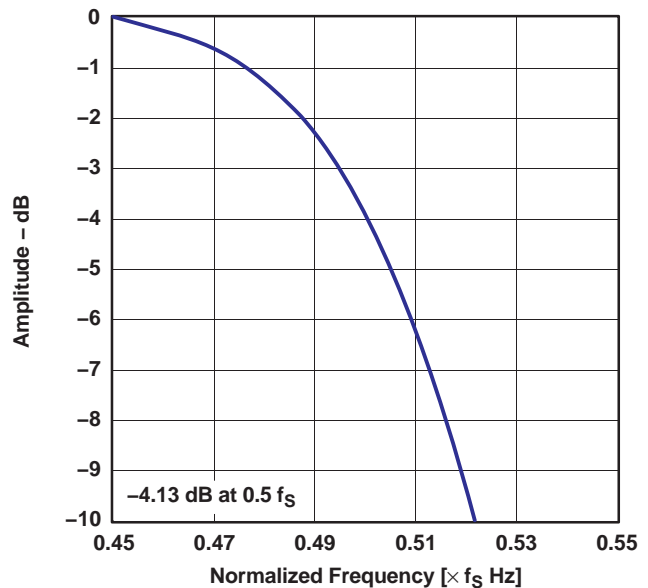

Figure 13.

All specifications at $T_A = 25^\circ\text{C}$, $V_{DD} = V_{CC} = 5\text{ V}$, slave mode, $f_S = 44.1\text{ kHz}$, 20-bit input data, and $\text{SYSCLK} = 384 f_S$, unless

TYPICAL PERFORMANCE CURVES FOR INTERNAL FILTERS (continued)

All specifications at $T_A = 25^\circ\text{C}$, $V_{DD} = V_{CC} = 5\text{ V}$, slave mode, $f_S = 44.1\text{ kHz}$, 20-bit input data, and $\text{SYSCLK} = 384 f_S$, unless otherwise noted

otherwise noted

HIGH-PASS FILTER

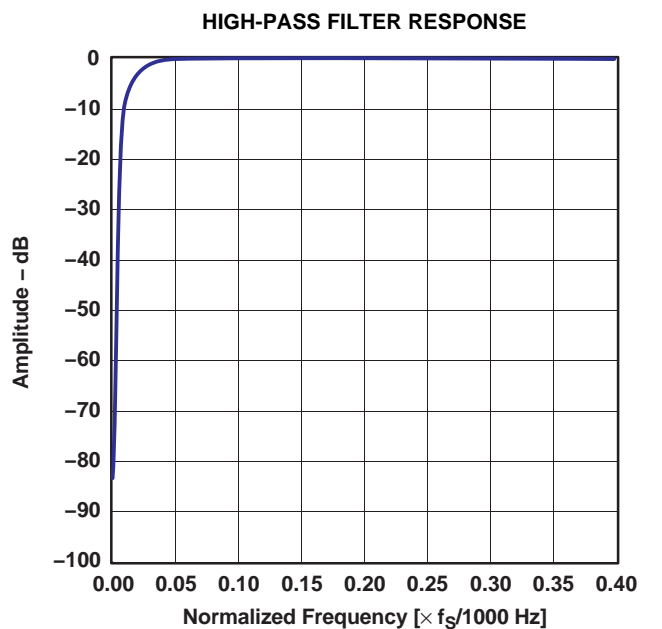

Figure 14.

G014

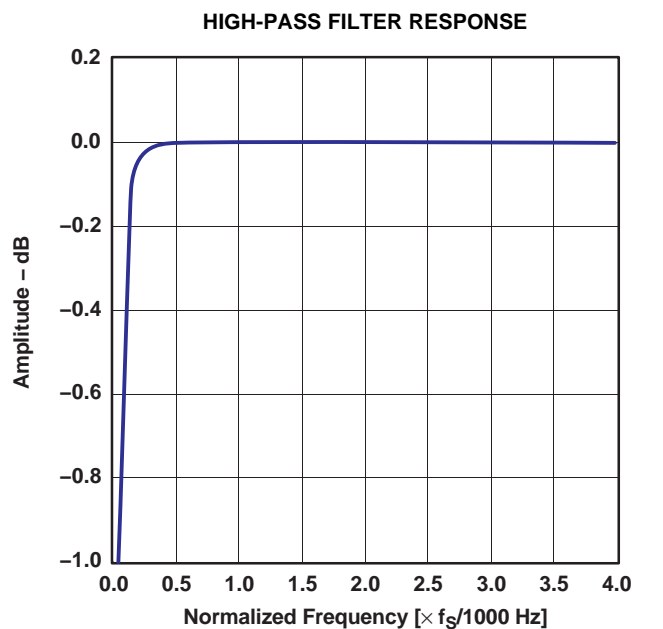

Figure 15.

G015

ANTI_ALIASING FILTER

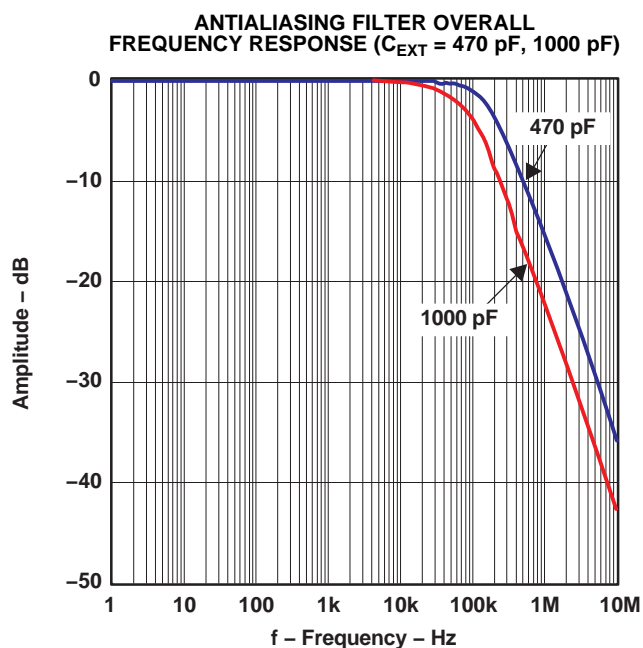

Figure 16.

G016

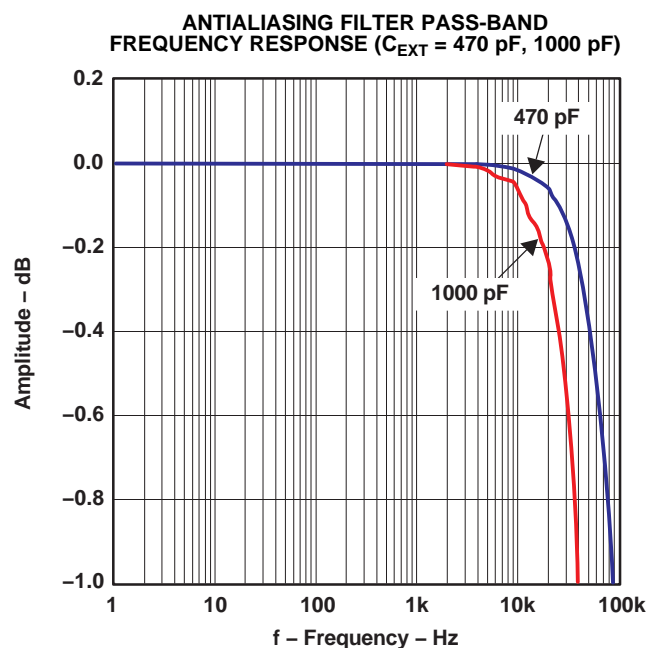

Figure 17.

G017

THEORY OF OPERATION

The PCM1800 consists of a band-gap reference, two channels of a single-to-differential converter, a fully differential 5th-order delta-sigma modulator, a decimation filter (including digital high pass), and a serial interface circuit. The block diagram illustrates the total architecture of the PCM1800 and the analog front-end diagram illustrates the architecture of the single-to-differential converter and the antialiasing filter. Figure 18 illustrates the architecture of the 5th-order delta-sigma modulator and transfer functions.

An internal high-precision reference with two external capacitors provides all the reference voltages that are required by the converter, and defines the full-scale voltage range of both channels. The internal single-to-differential voltage converter saves the design, space, and extra parts needed for external circuitry required by many delta-sigma converters. The internal full-differential architecture provides a wide dynamic range and excellent power-supply rejection performance.

The input signal is sampled at a 64x oversampling rate, eliminating the need for a sample-and-hold circuit, and simplifying antialias filtering requirements. The 5th-order delta-sigma noise shaper consists of five integrators which use a switched-capacitor topology, a comparator, and a feedback loop consisting of a 1-bit DAC. The delta-sigma modulator shapes the quantization noise, shifting it out of the audio band in the frequency domain. The high order of the modulator enables it to randomize the modulator outputs, reducing idle tone levels.

The 64- f_s , 1-bit stream from the modulator is converted to 1- f_s , 20-bit digital data by the decimation filter, which also acts as a low-pass filter to remove the shaped quantization noise. The dc components are removed by a high-pass filter, and the filtered output is converted to time-multiplexed serial signals through a serial interface which provides flexible serial formats and master/slave modes.

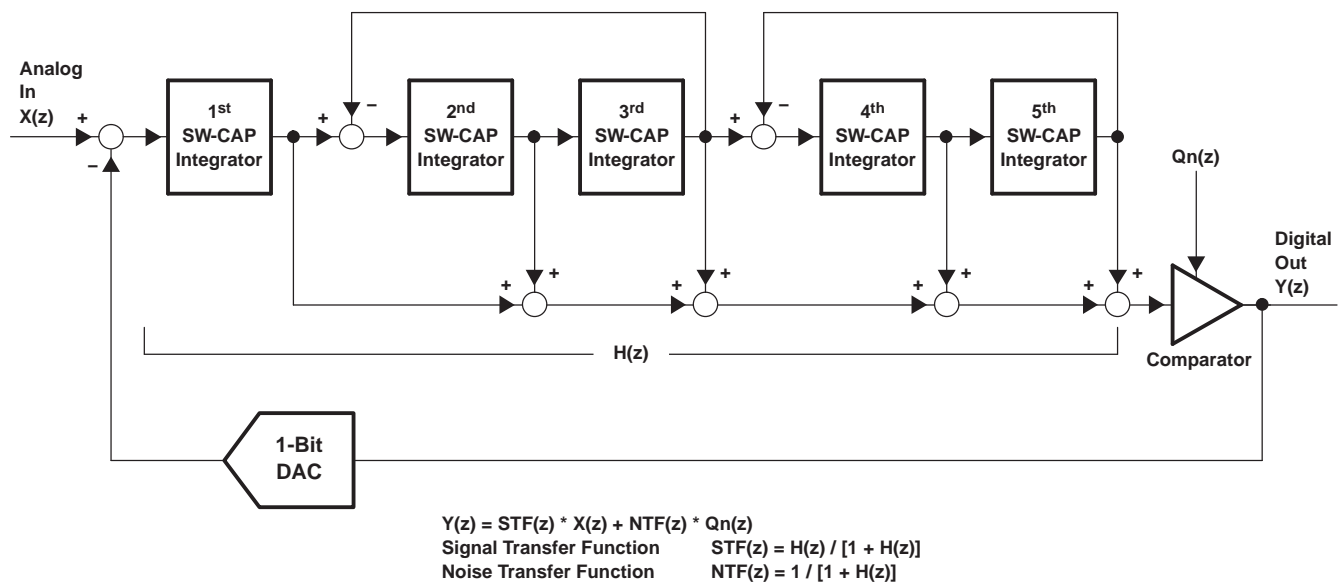

B0005-01

Figure 18. Simplified Diagram of the PCM1800 5th-Order Delta-Sigma Modulator

SYSTEM CLOCK

The system clock for the PCM1800 must be either 256 f_s , 384 f_s , or 512 f_s , where f_s is the audio sampling frequency. The system clock must be supplied on SYSCLK (pin 16).

The PCM1800 also has a system-clock detection circuit which automatically senses if the system clock is operating at 256 f_s , 384 f_s , or 512 f_s .

When the 384- f_s or 512- f_s system clock is in slave mode, the system clock is divided into 256 f_s automatically. The 256- f_s clock is used to operate the digital filter and the modulator. Table 1 lists the relationship of typical sampling frequencies and system clock frequencies. Figure 19 illustrates the system clock timing.

Table 1. System Clock Frequencies

SAMPLING RATE FREQUENCY (kHz)	SYSTEM CLOCK FREQUENCY (MHz)		
	256 f _s	384 f _s	512 f _s
32	8.1920	12.2880	16.3840
44.1	11.2896	16.9344	22.5792
48	12.2880	18.4320	24.5760

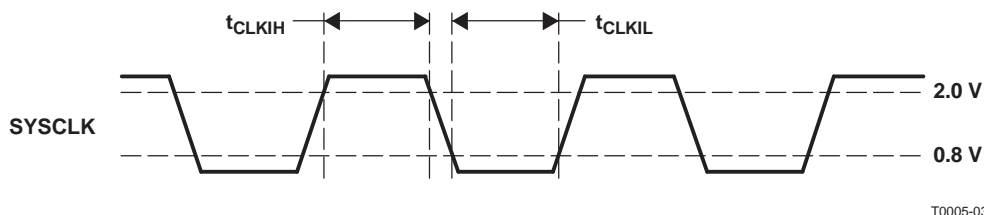

T0005-03

System clock pulse duration, HIGH	t _(CLKIH)	12 ns (min)
System clock pulse duration, LOW	t _(CLKIL)	12 ns (min)

Figure 19. System Clock Timing

RESET AND POWER DOWN

The PCM1800 has both an internal power-on reset circuit and an external forced reset (RSTB, pin 6). The internal power-on reset initializes (resets) when the supply voltage (V_{CC}/V_{DD}) exceeds 4 V (typical). To initiate the reset sequence externally, apply a logic-level LOW to the RSTB pin.

The RSTB pin is terminated by an internal pulldown resistor. If the RSTB pin is unconnected, the ADC remains in the reset state. Because the system clock is used as the clock signal for the reset circuit, the system clock must be supplied as soon as power is applied; more specifically, the device must receive at least three system clock cycles before V_{DD} > 4 V and RSTB = HIGH. If this system clock requirement cannot be assured in an application, RSTB must be held LOW until the system clock is supplied. While V_{CC}/V_{DD} < 4 V (typical), RSTB = LOW, and for 1024 system clock periods after V_{CC}/V_{DD} > 4.0 V and RSTB = HIGH, the PCM1800 stays in the reset state and the digital output is forced to zero. The digital output is valid 18,436 f_s periods after release from the reset state. During reset, the logic circuits and the digital filter stop operating and enter the power-down mode. Figure 20 and Figure 21 illustrate the internal power-on reset and external reset timing.

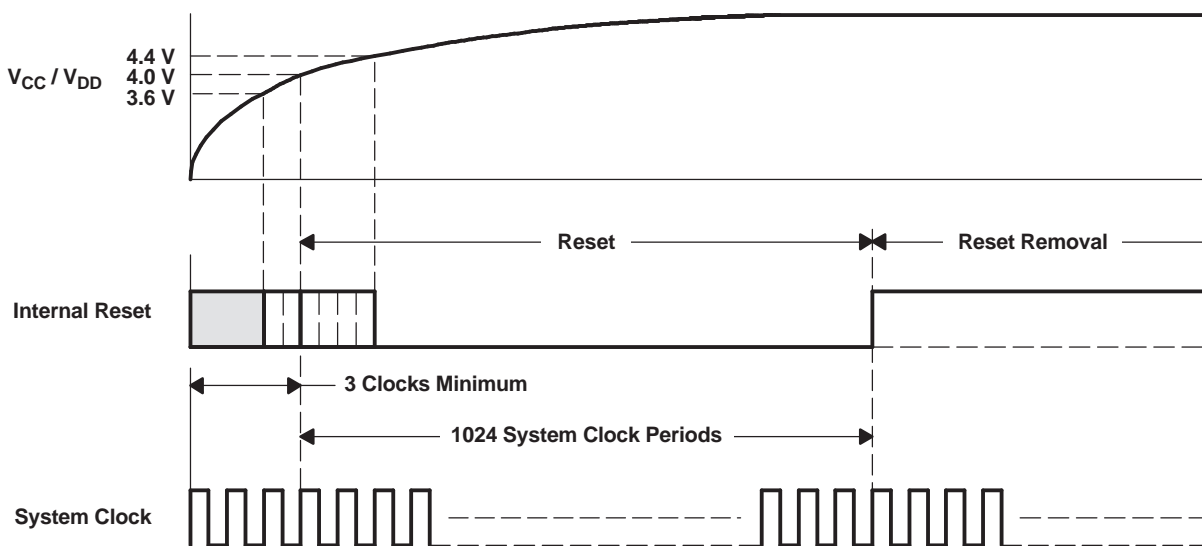

T0014-01

Figure 20. Internal Power-On Reset Timing

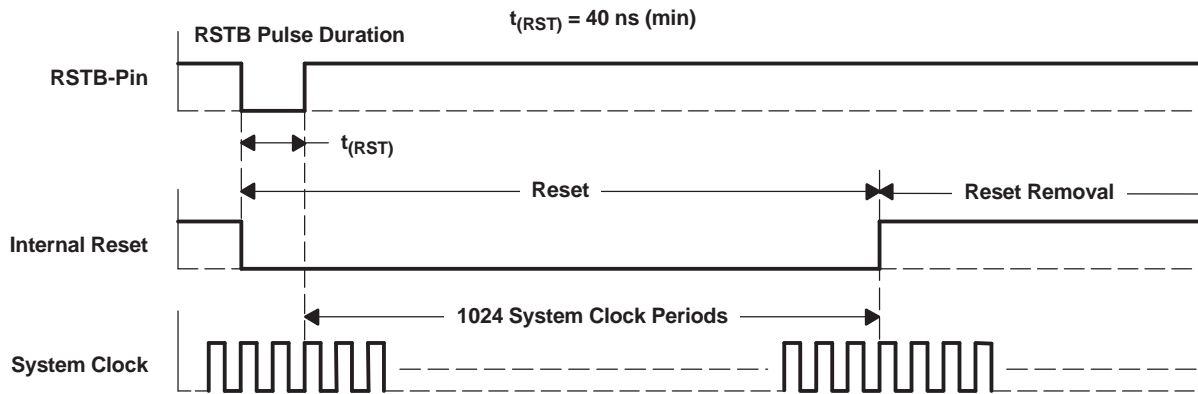

T0015-01

Figure 21. RSTB-Pin Reset Timing

SERIAL AUDIO DATA INTERFACE

The PCM1800 interfaces with the audio system through BCK (pin 14), LRCK (pin 13), FSYNC (pin 12), and DOUT (pin 15).

INTERFACE MODE

The PCM1800 supports master and slave modes as interface modes, which are selected by MODE1 (pin 11) and MODE0 (pin 10), as shown in Table 2. When in master mode, the PCM1800 provides the timing for serial audio data communications between the PCM1800 and the digital audio processor or external circuit. When in slave mode, the PCM1800 receives the timing for data transfer from an external controller.

Table 2. Interface Mode

MODE1	MODE0	INTERFACE MODE
0	0	Slave mode (256/384/512 f_S)
0	1	Master mode (512 f_S)
1	0	Master mode (384 f_S)
1	1	Master mode (256 f_S)

MASTER MODE

In master mode, BCK, LRCK, and FSYNC are output pins and are controlled by timing generated in the clock circuitry of the PCM1800.

FSYNC is used to designate the valid data from the PCM1800. The rising edge of FSYNC indicates the starting point of the converted audio data, and the following edge of this signal indicates the ending point of data. The frequency of this signal is fixed at $2 \times$ LRCK, and the duty-cycle ratio depends on the data bit length. The frequency of BCK is fixed at $64 \times$ LRCK.

SLAVE MODE

In slave mode, BCK, LRCK, and FSYNC are input pins. The PCM1800 accepts 64-BCK/LRCK, 48-BCK/LRCK (only for a 384- f_S system clock) or 32-BCK/LRCK format (only for 16-bit, right-justified format). FSYNC is used to enable the BCK signal, and the PCM1800 can shift out the converted data when FSYNC is HIGH.

DATA FORMAT

The PCM1800 supports four audio data formats in both master and slave modes. These data formats are selected by FMT1 (pin 9) and FMT0 (pin 8), as shown in Table 3. Figure 22 and Figure 23 illustrate the data formats in slave mode and master mode, respectively.

Table 3. Data Format

FORMAT NO.	FMT1 ⁽¹⁾	FMT0 ⁽¹⁾	DATA FORMAT
0	0	0	20-bit, left-justified
1	0	1	20-bit, I ² S
2	1	0	16-bit, right-justified
3	1	1	20-bit, right-justified

(1) FMT1 and FMT0 must be stable when RSTB changes from LOW to HIGH.

FORMAT 0: FMT[1:0] = 00

20-Bit, MSB-First, Left-Justified

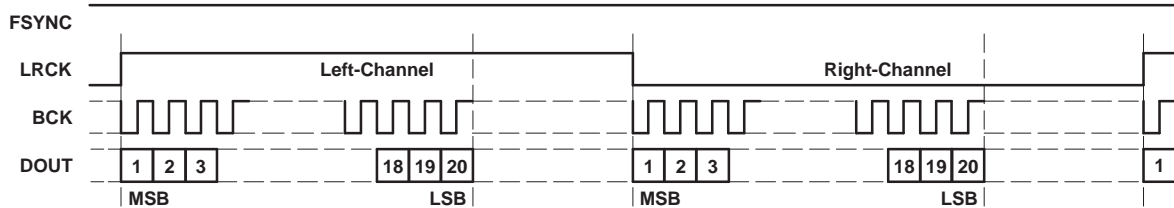

FORMAT 1: FMT[1:0] = 01

20-Bit, MSB-First, I²S

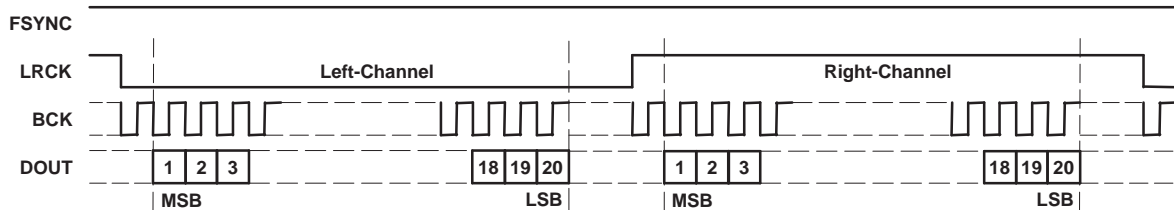

FORMAT 2: FMT[1:0] = 10

16-Bit, MSB-First, Right-Justified

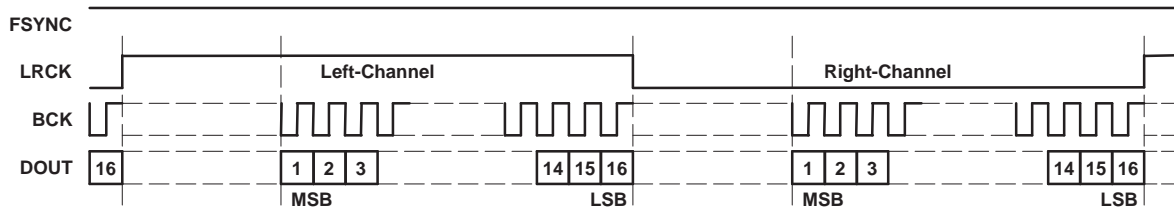

FORMAT 3: FMT[1:0] = 11

20-Bit, MSB-First, Right-Justified

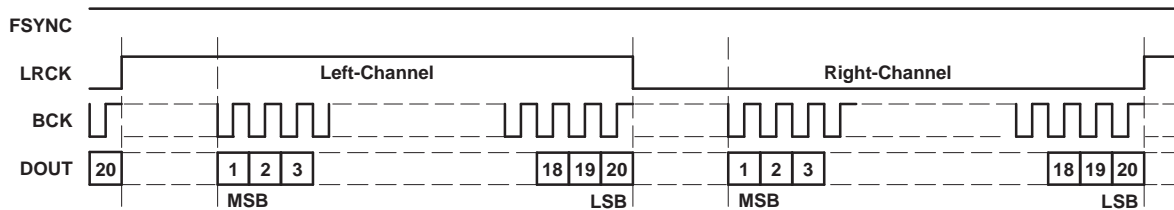

T0016-01

Figure 22. Audio Data Format (Slave Mode: FSYNC, LRCK, and BCK Are Inputs)

FORMAT 0: FMT[1:0] = 00

20-Bit, MSB-First, Left-Justified

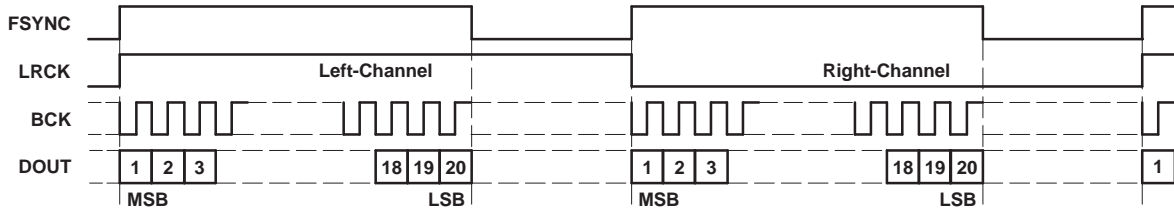

FORMAT 1: FMT[1:0] = 01

20-Bit, MSB-First, I²S

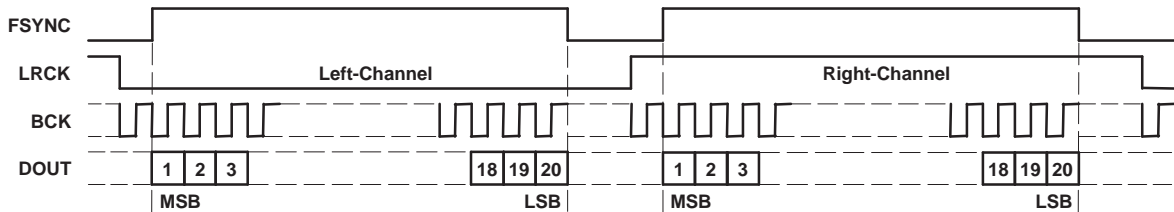

FORMAT 2: FMT[1:0] = 10

16-Bit, MSB-First, Right-Justified

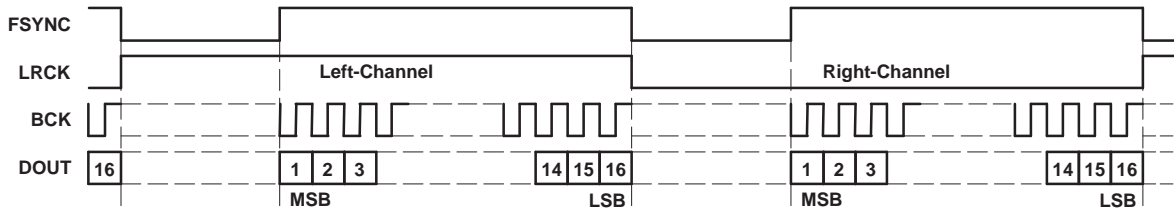

FORMAT 3: FMT[1:0] = 11

20-Bit, MSB-First, Right-Justified

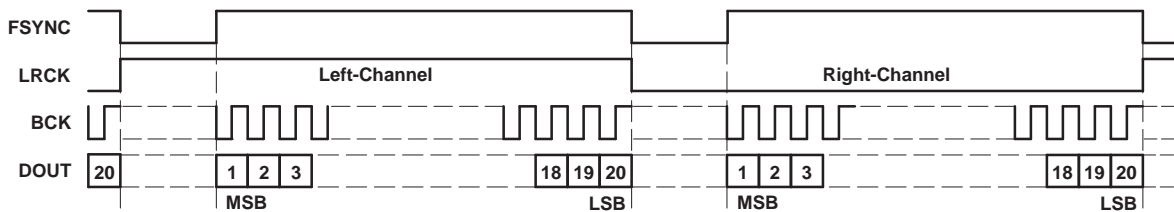

T0016-02

Figure 23. Audio Data Format (Master Mode: FSYNC, LRCK, and BCK Are Outputs)

INTERFACE TIMING

Figure 24 and Figure 25 illustrate the interface timing in slave mode and master mode, respectively.

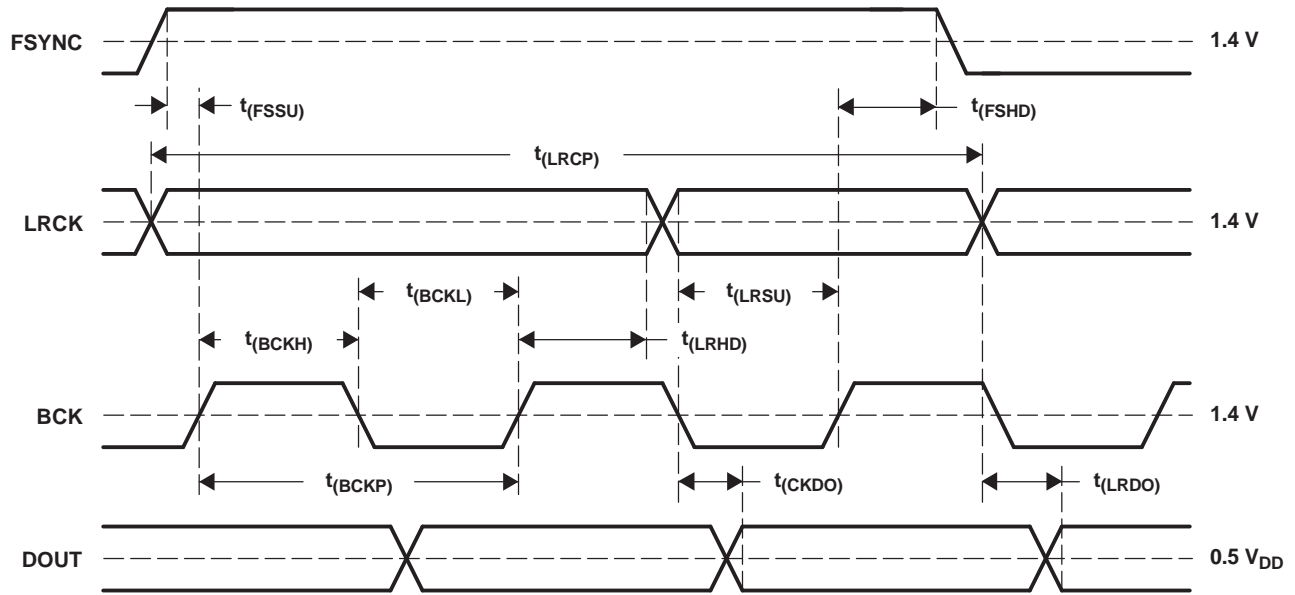

T0017-01

DESCRIPTION	SYMBOL	MIN	TYP	MAX	UNITS
BCK period	$t_{(BCKP)}$	300			ns
BCK pulse duration, HIGH	$t_{(BCKH)}$	120			ns
BCK pulse duration, LOW	$t_{(BCKL)}$	120			ns
LRCK setup time to BCK rising edge	$t_{(LRSU)}$	80			ns
LRCK hold time to BCK rising edge	$t_{(LRHD)}$	40			ns
LRCK period	$t_{(LRCP)}$	20			μ s
FSYNC setup time to BCK rising edge	$t_{(FSSU)}$	40			ns
FSYNC hold time to BCK rising edge	$t_{(FSHD)}$	40			ns
Delay time, BCK falling edge to DOUT valid	$t_{(CKDO)}$	-20		40	ns
Delay time, LRCK edge to DOUT valid	$t_{(LRDO)}$	-20		40	ns
Rising time of all signals	$t_{(RISE)}$			20	ns
Falling time of all signals	$t_{(FALL)}$			20	ns

NOTE: Timing measurement reference level is $(V_{IH} + V_{IL})/2$. Rising and falling time is measured from 10% to 90% of the I/O signal swing. Load capacitance of the DOUT signal is 20 pF.

Figure 24. Audio Data Interface Timing (Slave Mode: FSYNC, LRCK, and BCK Are Inputs)

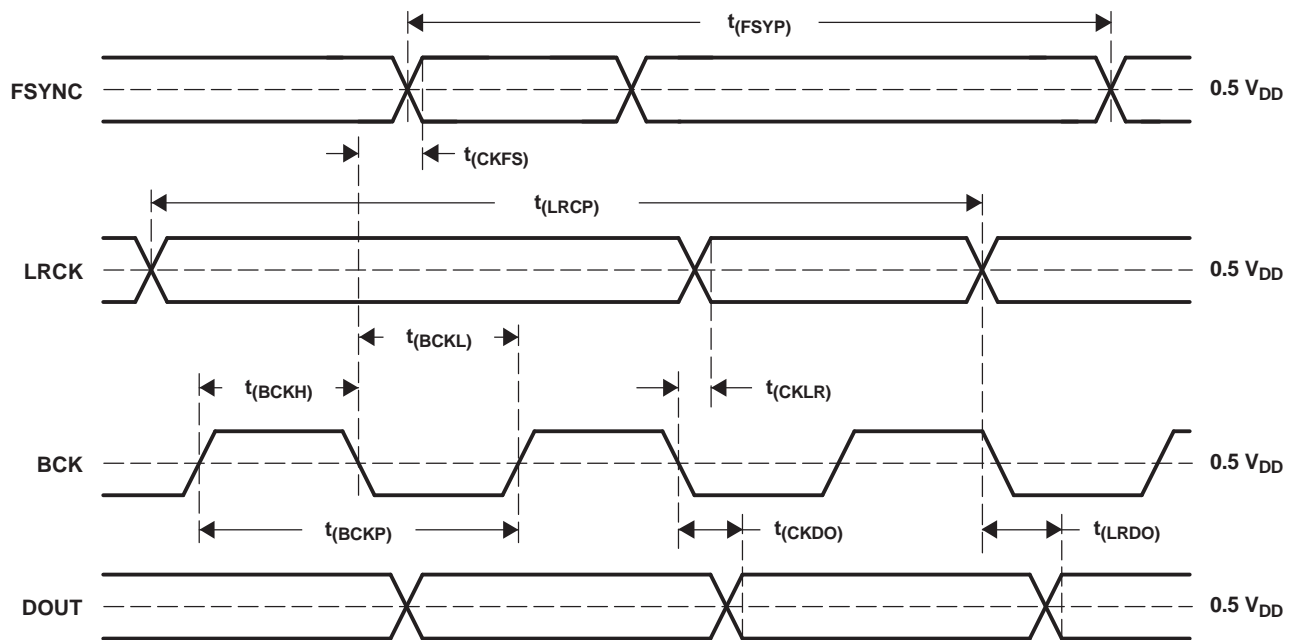

T0018-01

DESCRIPTION	SYMBOL	MIN	TYP	MAX	UNITS
BCK period	$t_{(BCKP)}$	300	$1/64 f_s$	4800	ns
BCK pulse duration, HIGH	$t_{(BCKH)}$	150		2400	ns
BCK pulse duration, LOW	$t_{(BCKL)}$	150		2400	ns
Delay time, BCK falling edge to LRCK valid	$t_{(CKLR)}$	-20		40	ns
LRCK period	$t_{(LRCP)}$	20	$1/f_s$	320	μs
Delay time, BCK falling edge to FSYNC valid	$t_{(CKFS)}$	-20		40	ns
FSYNC period	$t_{(FSYP)}$	10	$1/2 f_s$	160	μs
Delay time, BCK falling edge to DOUT valid	$t_{(CKDO)}$	-20		40	ns
Delay time, LRCK edge to DOUT valid	$t_{(LRDO)}$	-20		40	ns
Rising time of all signals	$t_{(RISE)}$			20	ns
Falling time of all signals	$t_{(FALL)}$			20	ns

NOTE: Timing measurement reference level is $(V_{IH} + V_{IL})/2$. Rising and falling time is measured from 10% to 90% of the I/O signal swing. Load capacitance of the DOUT signal is 20 pF.

Figure 25. Audio Data Interface Timing (Master Mode: FSYNC, LRCK, and BCK Are Outputs)

SYNCHRONIZATION WITH DIGITAL AUDIO SYSTEM

In slave mode, the PCM1800 operates with LRCK synchronized to the system clock (SYSCLK). The PCM1800 does not require a specific phase relationship between LRCK and SYSCLK, but does require the synchronization of LRCK and SYSCLK. If the relationship between LRCK and SYSCLK changes more than 6 bit clocks (BCK) during one sample period due to LRCK or SYSCLK jitter, internal operation of the ADC halts within $1/f_s$ and the digital output is forced into the BPZ mode until resynchronization between LRCK and SYSCLK is completed. In case of changes less than 5 bit clocks (BCK), resynchronization does not occur, and the previously described digital output control and discontinuity does not occur.

ADC DATA OUTPUT AT RESET

Figure 26 and Figure 27 illustrate the ADC digital output when the reset operation is done and when synchronization is lost, respectively. During undefined data, some noise may be generated in the audio signal. Also, the transition of normal to undefined data and undefined or zero data to normal makes a discontinuity in the data on the digital output, and may generate some noise in the audio signal.

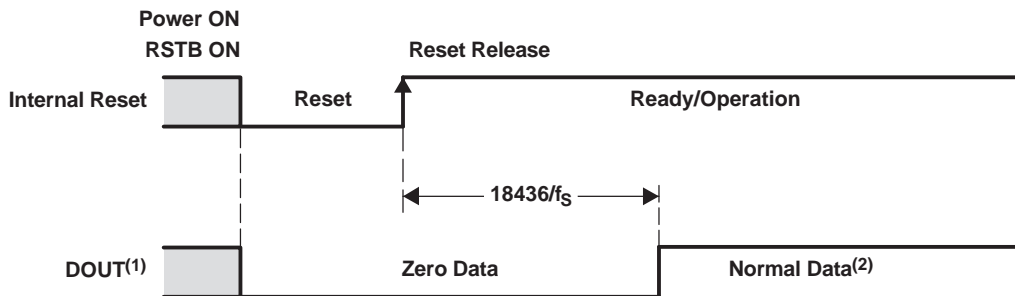

T0019-01

- (1) In the master mode, FSYNC, BCK, and LRCK are outputs similar to DOUT.
- (2) The HPF transient response (exponentially attenuated signal from $\pm 0.2\%$ dc of FSR with 200-ms time constant) appears initially.

Figure 26. ADC Digital Output for Power-On Reset and RSTB Control

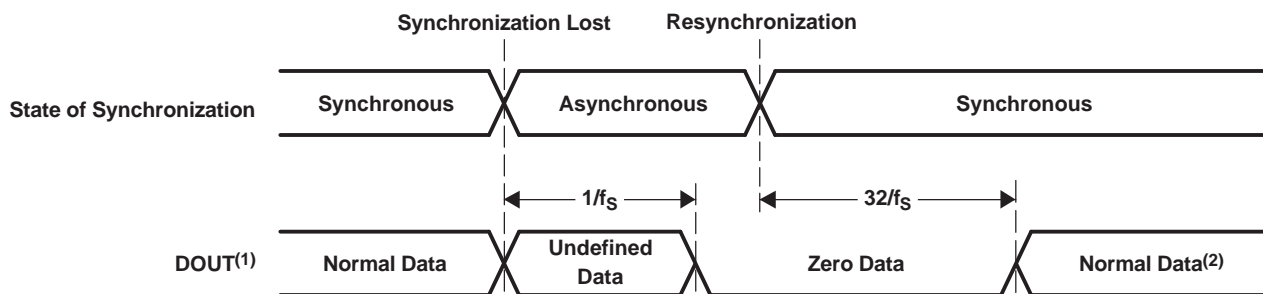

T0020-01

- (1) Applies only for slave mode—the loss of synchronization never occurs in master mode.
- (2) The HPF transient response (exponentially attenuated signal from $\pm 0.2\%$ dc of FSR with 200-ms time constant) appears initially.

Figure 27. ADC Digital Output During Loss of Synchronization Resynchronization

HPF BYPASS CONTROL

The built-in function for dc component rejection can be bypassed by BYPAS (pin 7) control (see Table 4). In bypass mode, the dc component of the input analog signal, the internal dc offset, etc., are also converted and output in the digital output data.

Table 4. HPF Bypass Control

BYPAS	HIGH-PASS FILTER (HPF) MODE
Low	Normal (dc cut) mode
High	Bypass (through) mode

APPLICATION INFORMATION

BOARD DESIGN AND LAYOUT CONSIDERATIONS

V_{CC} , V_{DD} PINS

The digital and analog power supply lines to the PCM1800 should be bypassed to the corresponding ground pins with both 0.1- μ F ceramic and 10- μ F tantalum capacitors as close to the pins as possible to maximize the dynamic performance of the ADC. Although the PCM1800 has two power lines to maximize the potential of dynamic performance, using one common power supply is recommended to avoid unexpected power supply problems, such as latch-up or power supply sequence.

AGND, DGND PINS

To maximize the dynamic performance of the PCM1800, the analog and digital grounds are not internally connected. These points should have low impedance to avoid digital noise feedback into the analog ground. They should be connected directly to each other under the part to reduce potential noise problems.

V_{IN} PINS

A 1- μ F tantalum capacitor is recommended as an ac-coupling capacitor, which establishes a 5.3-Hz cutoff frequency. If a higher full-scale input voltage is required, the input voltage range can be increased by adding a series resistor to the V_{IN} pins.

V_{REF} INPUTS

A 4.7- μ F tantalum capacitor is recommended between V_{REF1} , V_{REF2} , and REFCOM to ensure low source impedance for the ADC references. These capacitors should be located as close as possible to the V_{REF1} and V_{REF2} pins to reduce dynamic errors on the ADC references. The REFCOM pin also should be connected directly to AGND under the part.

C_{INP} and C_{INN} INPUTS

A 470-pF to 1000-pF film capacitor is recommended between C_{INPL} and C_{INNL} , C_{INPR} and C_{INNR} to create an antialiasing filter which has a 170-kHz to 80-kHz cutoff frequency. These capacitors should be located as close as possible to the C_{INP} and C_{INN} pins to avoid introducing unexpected noise or dynamic errors into the delta-sigma modulator. Four 10-pF–47-pF capacitors between C_{INXX} and AGND may improve dynamic performance under disadvantageous actual conditions.

DOUT, BCK, LRCK, FSYNC PINS

In master mode, the DOUT, BCK, LRCK and FSYNC pins have a large load-drive capability, but locating the buffer near the PCM1800 and minimizing the load capacitance is recommended in order to minimize the digital-analog crosstalk and to maximize dynamic performance potential.

SYSTEM CLOCK

The quality of the system clock can influence dynamic performance in the PCM1800. The duty cycle, jitter, and threshold voltage at the system clock input pin must be carefully managed. When power is supplied to the part, the system clock, bit clock (BCK), and word clock (LRCK) should also be supplied simultaneously. Failure to supply the audio clocks results in a power dissipation increase of up to three times normal dissipation and can degrade long-term reliability if the maximum power dissipation limit is exceeded.

RSTB CONTROL

If the capacitance between V_{REF1} and V_{REF2} exceeds 4.7 μ F, an external reset control with a delay-time circuit must be used.

TYPICAL CIRCUIT CONNECTION DIAGRAM

Figure 28 is a typical circuit connection diagram for which the cutoff frequency of the input HPF is about 5 Hz.

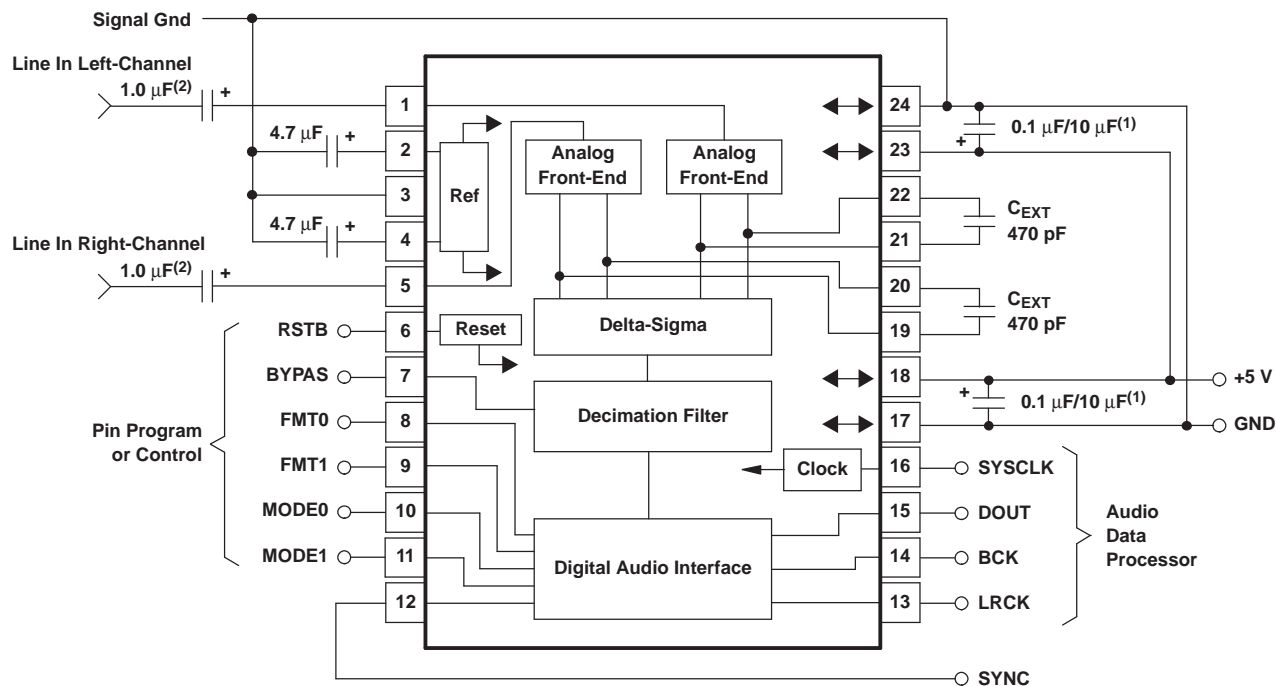

S0012-01

- (1) Bypass capacitor = 0.1-μF ceramic and 10-μF tantalum, depending on layout and power supply.
- (2) A 1-μF capacitor gives a 5.3-Hz cutoff frequency for the input HPF in normal operation and requires a power-on settling period with a 30-ms time constant during power-on initialization.

Figure 28. Typical Circuit Connection

PACKAGING INFORMATION

Orderable Device	Status ⁽¹⁾	Package Type	Package Drawing	Pins	Package Qty	Eco Plan ⁽²⁾	Lead/ Ball Finish	MSL Peak Temp ⁽³⁾	Samples (Requires Login)
PCM1800E	NRND	SSOP	DB	24	58	Green (RoHS & no Sb/Br)	CU NIPDAU	Level-1-260C-UNLIM	
PCM1800E/2K	NRND	SSOP	DB	24	2000	Green (RoHS & no Sb/Br)	CU NIPDAU	Level-1-260C-UNLIM	
PCM1800E/2KG4	NRND	SSOP	DB	24	2000	Green (RoHS & no Sb/Br)	CU NIPDAU	Level-1-260C-UNLIM	
PCM1800EG4	NRND	SSOP	DB	24	58	Green (RoHS & no Sb/Br)	CU NIPDAU	Level-1-260C-UNLIM	

⁽¹⁾ The marketing status values are defined as follows:

ACTIVE: Product device recommended for new designs.

LIFEBUY: TI has announced that the device will be discontinued, and a lifetime-buy period is in effect.

NRND: Not recommended for new designs. Device is in production to support existing customers, but TI does not recommend using this part in a new design.

PREVIEW: Device has been announced but is not in production. Samples may or may not be available.

OBSOLETE: TI has discontinued the production of the device.

⁽²⁾ Eco Plan - The planned eco-friendly classification: Pb-Free (RoHS), Pb-Free (RoHS Exempt), or Green (RoHS & no Sb/Br) - please check <http://www.ti.com/productcontent> for the latest availability information and additional product content details.

TBD: The Pb-Free/Green conversion plan has not been defined.

Pb-Free (RoHS): TI's terms "Lead-Free" or "Pb-Free" mean semiconductor products that are compatible with the current RoHS requirements for all 6 substances, including the requirement that lead not exceed 0.1% by weight in homogeneous materials. Where designed to be soldered at high temperatures, TI Pb-Free products are suitable for use in specified lead-free processes.

Pb-Free (RoHS Exempt): This component has a RoHS exemption for either 1) lead-based flip-chip solder bumps used between the die and package, or 2) lead-based die adhesive used between the die and leadframe. The component is otherwise considered Pb-Free (RoHS compatible) as defined above.

Green (RoHS & no Sb/Br): TI defines "Green" to mean Pb-Free (RoHS compatible), and free of Bromine (Br) and Antimony (Sb) based flame retardants (Br or Sb do not exceed 0.1% by weight in homogeneous material)

⁽³⁾ MSL, Peak Temp. -- The Moisture Sensitivity Level rating according to the JEDEC industry standard classifications, and peak solder temperature.

Important Information and Disclaimer: The information provided on this page represents TI's knowledge and belief as of the date that it is provided. TI bases its knowledge and belief on information provided by third parties, and makes no representation or warranty as to the accuracy of such information. Efforts are underway to better integrate information from third parties. TI has taken and continues to take reasonable steps to provide representative and accurate information but may not have conducted destructive testing or chemical analysis on incoming materials and chemicals. TI and TI suppliers consider certain information to be proprietary, and thus CAS numbers and other limited information may not be available for release.

In no event shall TI's liability arising out of such information exceed the total purchase price of the TI part(s) at issue in this document sold by TI to Customer on an annual basis.

TAPE AND REEL INFORMATION



QUADRANT ASSIGNMENTS FOR PIN 1 ORIENTATION IN TAPE



*All dimensions are nominal

Device	Package Type	Package Drawing	Pins	SPQ	Reel Diameter (mm)	Reel Width W1 (mm)	A0 (mm)	B0 (mm)	K0 (mm)	P1 (mm)	W (mm)	Pin1 Quadrant
PCM1800E/2K	SSOP	DB	24	2000	330.0	17.4	8.5	8.6	2.4	12.0	16.0	Q1

TAPE AND REEL BOX DIMENSIONS



*All dimensions are nominal

Device	Package Type	Package Drawing	Pins	SPQ	Length (mm)	Width (mm)	Height (mm)
PCM1800E/2K	SSOP	DB	24	2000	336.6	336.6	28.6

DB (R-PDSO-G**)

PLASTIC SMALL-OUTLINE

28 PINS SHOWN



- NOTES: A. All linear dimensions are in millimeters.
 B. This drawing is subject to change without notice.
 C. Body dimensions do not include mold flash or protrusion not to exceed 0,15.
 D. Falls within JEDEC MO-150

IMPORTANT NOTICE

Texas Instruments Incorporated and its subsidiaries (TI) reserve the right to make corrections, modifications, enhancements, improvements, and other changes to its products and services at any time and to discontinue any product or service without notice. Customers should obtain the latest relevant information before placing orders and should verify that such information is current and complete. All products are sold subject to TI's terms and conditions of sale supplied at the time of order acknowledgment.

TI warrants performance of its hardware products to the specifications applicable at the time of sale in accordance with TI's standard warranty. Testing and other quality control techniques are used to the extent TI deems necessary to support this warranty. Except where mandated by government requirements, testing of all parameters of each product is not necessarily performed.

TI assumes no liability for applications assistance or customer product design. Customers are responsible for their products and applications using TI components. To minimize the risks associated with customer products and applications, customers should provide adequate design and operating safeguards.

TI does not warrant or represent that any license, either express or implied, is granted under any TI patent right, copyright, mask work right, or other TI intellectual property right relating to any combination, machine, or process in which TI products or services are used. Information published by TI regarding third-party products or services does not constitute a license from TI to use such products or services or a warranty or endorsement thereof. Use of such information may require a license from a third party under the patents or other intellectual property of the third party, or a license from TI under the patents or other intellectual property of TI.

Reproduction of TI information in TI data books or data sheets is permissible only if reproduction is without alteration and is accompanied by all associated warranties, conditions, limitations, and notices. Reproduction of this information with alteration is an unfair and deceptive business practice. TI is not responsible or liable for such altered documentation. Information of third parties may be subject to additional restrictions.

Resale of TI products or services with statements different from or beyond the parameters stated by TI for that product or service voids all express and any implied warranties for the associated TI product or service and is an unfair and deceptive business practice. TI is not responsible or liable for any such statements.

TI products are not authorized for use in safety-critical applications (such as life support) where a failure of the TI product would reasonably be expected to cause severe personal injury or death, unless officers of the parties have executed an agreement specifically governing such use. Buyers represent that they have all necessary expertise in the safety and regulatory ramifications of their applications, and acknowledge and agree that they are solely responsible for all legal, regulatory and safety-related requirements concerning their products and any use of TI products in such safety-critical applications, notwithstanding any applications-related information or support that may be provided by TI. Further, Buyers must fully indemnify TI and its representatives against any damages arising out of the use of TI products in such safety-critical applications.

TI products are neither designed nor intended for use in military/aerospace applications or environments unless the TI products are specifically designated by TI as military-grade or "enhanced plastic." Only products designated by TI as military-grade meet military specifications. Buyers acknowledge and agree that any such use of TI products which TI has not designated as military-grade is solely at the Buyer's risk, and that they are solely responsible for compliance with all legal and regulatory requirements in connection with such use.

TI products are neither designed nor intended for use in automotive applications or environments unless the specific TI products are designated by TI as compliant with ISO/TS 16949 requirements. Buyers acknowledge and agree that, if they use any non-designated products in automotive applications, TI will not be responsible for any failure to meet such requirements.

Following are URLs where you can obtain information on other Texas Instruments products and application solutions:

Products

Audio	www.ti.com/audio
Amplifiers	amplifier.ti.com
Data Converters	dataconverter.ti.com
DLP® Products	www.dlp.com
DSP	dsp.ti.com
Clocks and Timers	www.ti.com/clocks
Interface	interface.ti.com
Logic	logic.ti.com
Power Mgmt	power.ti.com
Microcontrollers	microcontroller.ti.com
RFID	www.ti-rfid.com
RF/IF and ZigBee® Solutions	www.ti.com/lprf

Applications

Communications and Telecom	www.ti.com/communications
Computers and Peripherals	www.ti.com/computers
Consumer Electronics	www.ti.com/consumer-apps
Energy and Lighting	www.ti.com/energy
Industrial	www.ti.com/industrial
Medical	www.ti.com/medical
Security	www.ti.com/security
Space, Avionics and Defense	www.ti.com/space-avionics-defense
Transportation and Automotive	www.ti.com/automotive
Video and Imaging	www.ti.com/video
Wireless	www.ti.com/wireless-apps

TI E2E Community Home Page

e2e.ti.com

Mailing Address: Texas Instruments, Post Office Box 655303, Dallas, Texas 75265
Copyright © 2011, Texas Instruments Incorporated