

PQxxxY3H3Z Series/PQxxxY053Z Series

Surface Mount, Large Output Current Type Low Power-Loss Voltage Regulators

Features

- Low power-loss (Dropout voltage: MAX. 0.5V)
- Compact surface mount type package
(Size:10.6×13.7×3.5mm)
- High output current type
- Low voltage operation (Minimum supply voltage: 2.35V)
- High-precision output type
(Output voltage precision: ± 1%)
- Overcurrent, overheat protection functions

Applications

- PC motherboard, PC peripherals
- Power supplies for various electronic equipment such as AV, OA

Model Line-up

Output current (I _o)	Package type	Output voltage (V _o)		
		1.5V	2.5V	3.3V
3.5A	Taping	PQ015Y3H3ZP	PQ025Y3H3ZP	PQ033Y3H3ZP
	Sleeve	PQ015Y3H3ZZ	PQ025Y3H3ZZ	PQ033Y3H3ZZ
5A	Taping	PQ015Y053ZP	PQ025Y053ZP	PQ033Y053ZP
	Sleeve	PQ015Y053ZZ	PQ025Y053ZZ	PQ033Y053ZZ

Absolute Maximum Ratings

(T_a=25°C)

Parameter	Symbol	Rating	Unit
Input voltage	V _{IN}	7	V
Dropout voltage	V _{L.O}	4	V
*1 ON/OFF control terminal voltage	V _C	7	V
Output current	PQxxxY3H3Z Series	3.5	A
	PQxxxY053Z Series	5	
*2 Power dissipation	P _D	35	W
*3 Junction temperature	T _j	150	°C
Operating temperature	T _{opr}	-20 to +80	°C
Storage temperature	T _{stg}	-40 to +150	°C
Soldering temperature	T _{sol}	260 (10s)	°C

*1 All are open except GND and applicable terminals.

*2 P_D:With infinite heat sink

*3 Overheat protection may operate at T_j=125°C to 150°C.

Outline Dimensions

(Unit : mm)

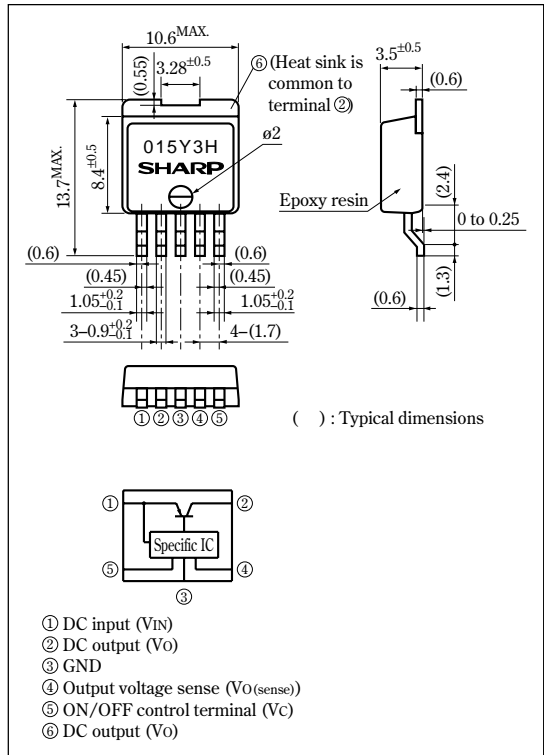

•Please refer to the chapter " Handling Precautions ".

SHARP

Notice In the absence of confirmation by device specification sheets, SHARP takes no responsibility for any defects that may occur in equipment using any SHARP devices shown in catalogs, data books, etc. Contact SHARP in order to obtain the latest device specification sheets before using any SHARP device.
 Internet Internet address for Electronic Components Group <http://sharp-world.com/ecg/>

Electrical Characteristics (PQ015Y3H3Z/PQ015Y053Z)

(Unless otherwise specified, condition shall be $V_{IN}=5V$, $I_O=1.75A$ (PQ015Y3H3Z), $I_O=2.5A$ (PQ015Y053Z), connects $V_{O(sense)}$ terminal to V_O terminal, $T_a=25^\circ C$)

Parameter	Symbol	Conditions	MIN.	TYP.	MAX.	Unit
Input voltage	V_{IN}	–	2.35	–	7	V
*4 Output voltage	V_O	Connects $V_{O(sense)}$ terminal to V_O terminal	1.485	1.5	1.515	V
Load regulation	PQ015Y3H3Z	R_{regL}	–	0.1	0.5	%
	PQ015Y053Z					
Line regulation	R_{regI}	$V_{IN}=2.5$ to 5.5V, $I_O=5mA$	–	0.05	0.1	%
Temperature coefficient of output voltage	TcV_O	$T_j=0$ to 125°C, $I_O=5mA$	–	±1	–	%
Ripple rejection	RR	Refer to Fig.2	60	70	–	dB
*5 ON-state voltage for control	$V_{C(ON)}$	–	2.0	–	–	V
ON-state current for control	$I_{C(ON)}$	$V_C=2.7V$	–	–	20	µA
OFF-state voltage for control	$V_{C(OFF)}$	–	–	–	0.8	V
OFF-state current for control	$I_{C(OFF)}$	$V_C=0.4V$	–	–	–0.4	mA
Quiescent current	I_q	$I_O=0A$	–	5	10	mA

Electrical Characteristics (PQ025Y3H3Z/PQ025Y053Z)

(Unless otherwise specified, condition shall be $V_{IN}=5V$, $I_O=1.75A$ (PQ025Y3H3Z), $I_O=2.5A$ (PQ025Y053Z), connects $V_{O(sense)}$ terminal to V_O terminal, $T_a=25^\circ C$)

Parameter	Symbol	Conditions	MIN.	TYP.	MAX.	Unit
*4 Output voltage	V_O	Connects $V_{O(sense)}$ terminal to V_O terminal	2.475	2.5	2.525	V
Load regulation	PQ025Y3H3Z	R_{regL}	–	0.1	0.5	%
	PQ025Y053Z					
Line regulation	R_{regI}	$V_{IN}=3$ to 6.5V, $I_O=5mA$	–	0.05	0.1	%
Temperature coefficient of output voltage	TcV_O	$T_j=0$ to 125°C, $I_O=5mA$	–	±1	–	%
Ripple rejection	RR	Refer to Fig.2	60	70	–	dB
Dropout voltage	PQ025Y3H3Z	V_{I-O}	–	–	0.5	V
	PQ025Y053Z					
*5 ON-state voltage for control	$V_{C(ON)}$	–	2.0	–	–	V
ON-state current for control	$I_{C(ON)}$	$V_C=2.7V$	–	–	20	µA
OFF-state voltage for control	$V_{C(OFF)}$	–	–	–	0.8	V
OFF-state current for control	$I_{C(OFF)}$	$V_C=0.4V$	–	–	–0.4	mA
Quiescent current	I_q	$I_O=0A$	–	5	10	mA

Electrical Characteristics (PQ033Y3H3Z/PQ033Y053Z)

(Unless otherwise specified, condition shall be $V_{IN}=V_O(TYP)+1$, $I_O=1.75A$ (PQ033Y3H3Z), $I_O=2.5A$ (PQ033Y053Z), connects $V_{O(sense)}$ terminal to V_O terminal, $T_a=25^\circ C$)

Parameter	Symbol	Conditions	MIN.	TYP.	MAX.	Unit
*4 Output voltage	V_O	Connects $V_{O(sense)}$ terminal to V_O terminal	3.267	3.3	3.333	V
Load regulation	PQ033Y3H3Z	R_{regL}	–	0.1	0.5	%
	PQ033Y053Z					
Line regulation	R_{regI}	$V_{IN}=4$ to 7V, $I_O=5mA$	–	0.05	0.1	%
Temperature coefficient of Output voltage	TcV_O	$T_j=0$ to 125°C, $I_O=5mA$	–	±1	–	%
Ripple Rejection	RR	Refer to Fig2	60	70	–	dB
Dropout voltage	PQ033Y3H3Z	V_{I-O}	–	–	0.5	V
	PQ033Y053Z					
*5 ON-state voltage for control	$V_{C(ON)}$	–	2.0	–	–	V
ON-state current for control	$I_{C(ON)}$	$V_C=2.7V$	–	–	20	µA
OFF-state voltage for control	$V_{C(OFF)}$	–	–	–	0.8	V
OFF-state current for control	$I_{C(OFF)}$	$V_C=0.4V$	–	–	–0.4	mA
Quiescent current	I_q	$I_O=0A$	–	5	10	mA

*4 Connects $V_{O(sense)}$ terminal④ to V_O terminal②

*5 In case of opening control terminal⑤, output voltage turns ON.

*6 Input voltage shall be the value when output voltage is 95% in comparison with the initial value.

Fig.1 Test Circuit

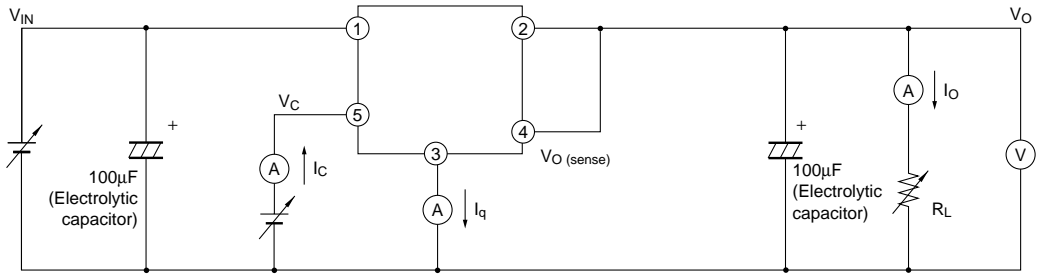

Fig.2 Test Circuit for Ripple Rejection

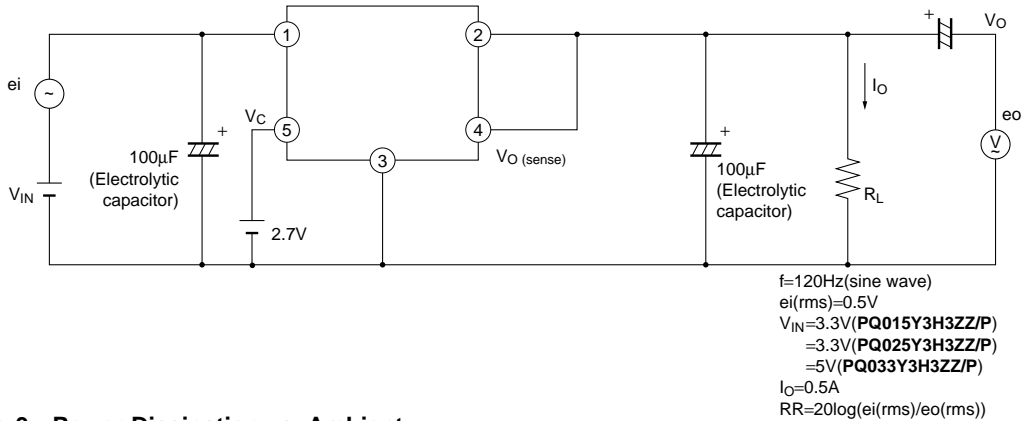
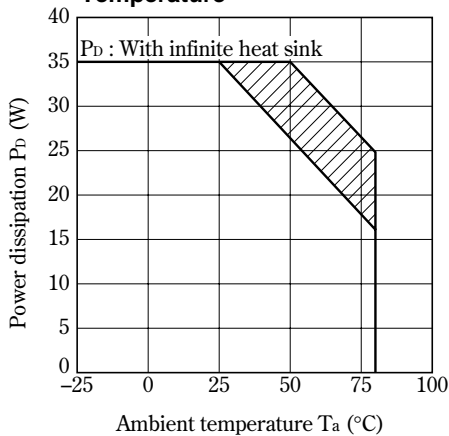

Fig.3 Power Dissipation vs. Ambient Temperature



Note) Oblique line portion: Overheat protection may operate in this area.

Fig.4 Overcurrent Protection Characteristics (PQ015Y3H3Z/PQ025Y3H3Z/PQ033Y3H3Z)

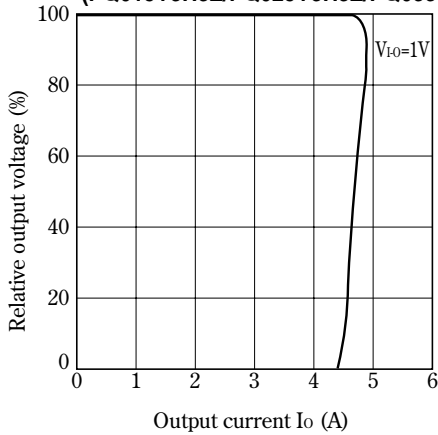

Fig.5 Overcurrent Protection Characteristics (PQ015Y053Z/PQ025Y053Z/PQ033Y053Z)

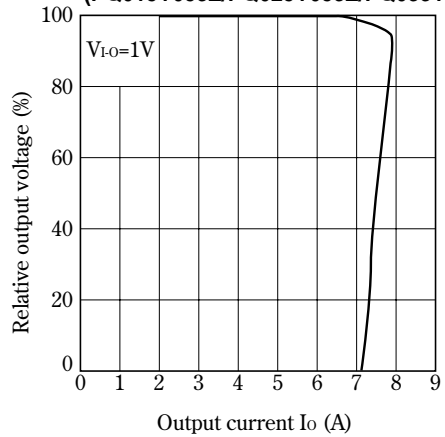

Fig.6 Output Voltage Fluctuation vs. Ambient Temperature

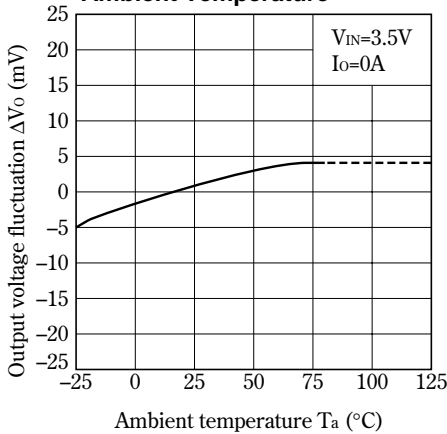

Fig.7 Output Voltage vs. Input Voltage (PQ015Y3H3Z)

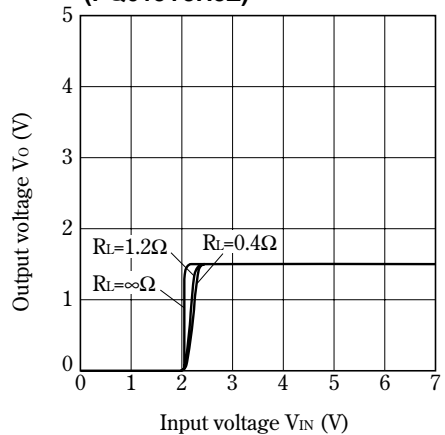

Fig.8 Output Voltage vs. Input Voltage (PQ015Y053Z)

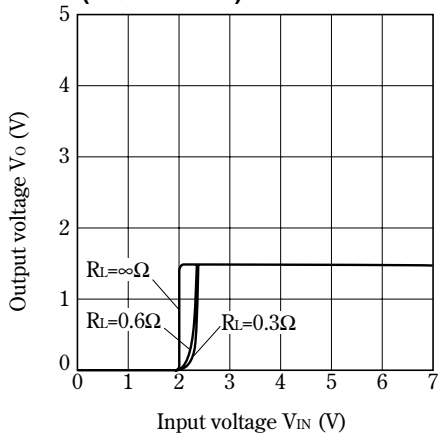

Fig.9 Output Voltage vs. Input Voltage (PQ025Y3H3Z)

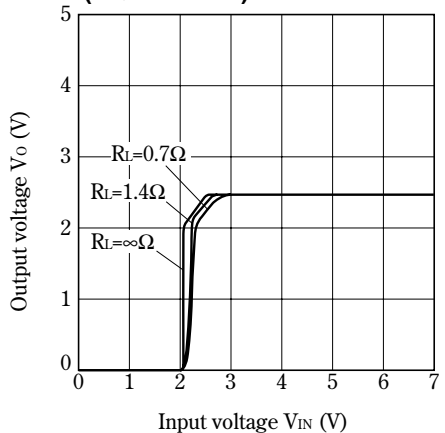

Fig.10 Output Voltage vs. Input Voltage (PQ025Y053Z)

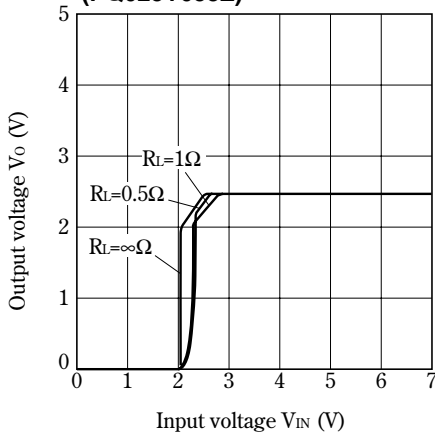

Fig.11 Output Voltage vs. Input Voltage (PQ033Y3H3Z)

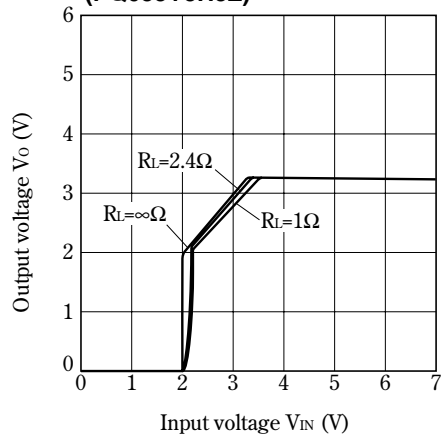

Fig.12 Circuit Operating Current vs. Input Voltage (PQ015Y3H3Z)

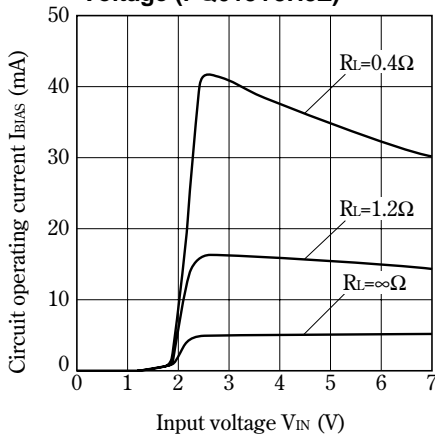

Fig.13 Circuit Operating Current vs. Input Voltage (PQ015Y053Z)

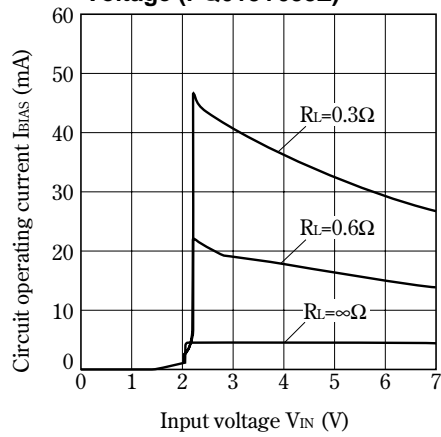

Fig.14 Circuit Operating Current vs. Input Voltage (PQ025Y3H3Z)

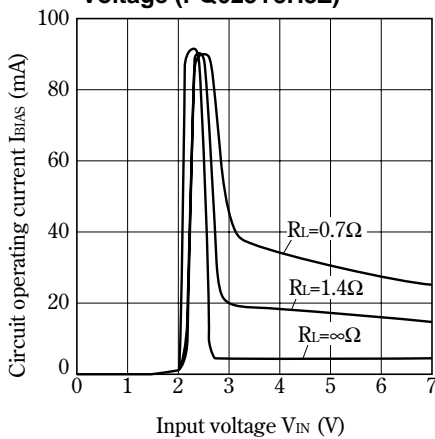

Fig.15 Circuit Operating Current vs. Input Voltage (PQ025Y053Z)

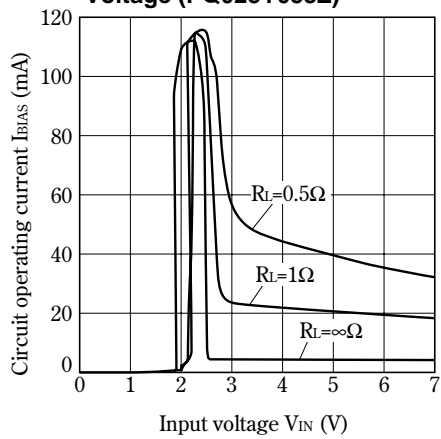

Fig.16 Circuit Operating Current vs. Input Voltage (PQ033Y3H3Z)

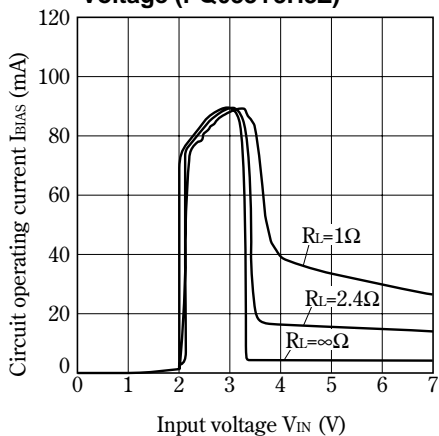

Fig.17 Ripple Rejection vs. Input Ripple Frequency (PQ025Y3H3Z)

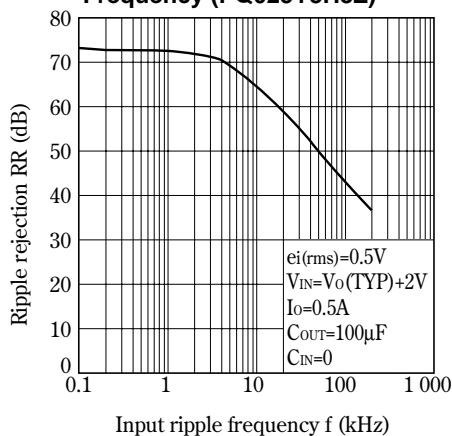
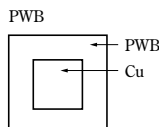
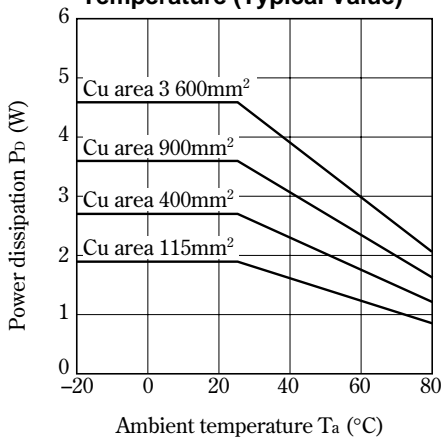
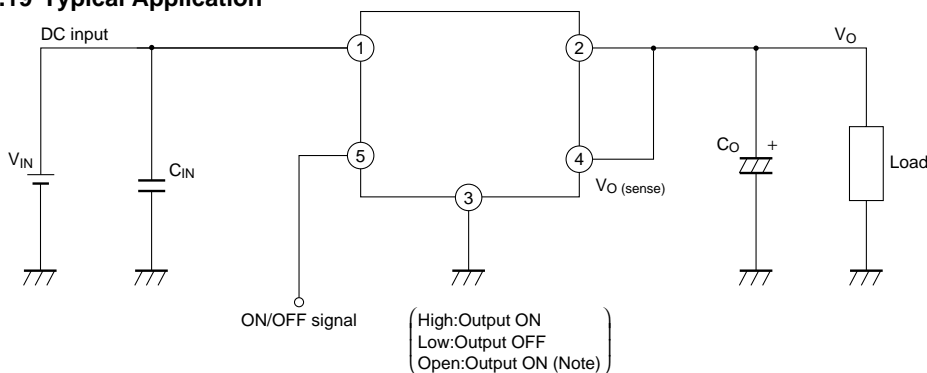

Fig.18 Power Dissipation vs. Ambient Temperature (Typical Value)



Material : Glass-cloth epoxy resin
 Size : 60×60×1.6mm
 Cu thickness : 65μm

Fig.19 Typical Application



* Please make sure to use this device, pulling up to the power supply with less than 7V at the resistor less than 50kΩ in switching ON/OFF with open collector output or in not using ON/OFF function (in keeping "ON"), because input impedance is high in ON/OFF terminals.

NOTICE

- The circuit application examples in this publication are provided to explain representative applications of SHARP devices and are not intended to guarantee any circuit design or license any intellectual property rights. SHARP takes no responsibility for any problems related to any intellectual property right of a third party resulting from the use of SHARP's devices.
- Contact SHARP in order to obtain the latest device specification sheets before using any SHARP device. SHARP reserves the right to make changes in the specifications, characteristics, data, materials, structure, and other contents described herein at any time without notice in order to improve design or reliability. Manufacturing locations are also subject to change without notice.
- Observe the following points when using any devices in this publication. SHARP takes no responsibility for damage caused by improper use of the devices which does not meet the conditions and absolute maximum ratings to be used specified in the relevant specification sheet nor meet the following conditions:
 - (i) The devices in this publication are designed for use in general electronic equipment designs such as:
 - Personal computers
 - Office automation equipment
 - Telecommunication equipment [terminal]
 - Test and measurement equipment
 - Industrial control
 - Audio visual equipment
 - Consumer electronics
 - (ii) Measures such as fail-safe function and redundant design should be taken to ensure reliability and safety when SHARP devices are used for or in connection with equipment that requires higher reliability such as:
 - Transportation control and safety equipment (i.e., aircraft, trains, automobiles, etc.)
 - Traffic signals
 - Gas leakage sensor breakers
 - Alarm equipment
 - Various safety devices, etc.
 - (iii) SHARP devices shall not be used for or in connection with equipment that requires an extremely high level of reliability and safety such as:
 - Space applications
 - Telecommunication equipment [trunk lines]
 - Nuclear power control equipment
 - Medical and other life support equipment (e.g., scuba).
- Contact a SHARP representative in advance when intending to use SHARP devices for any "specific" applications other than those recommended by SHARP or when it is unclear which category mentioned above controls the intended use.
- If the SHARP devices listed in this publication fall within the scope of strategic products described in the Foreign Exchange and Foreign Trade Control Law of Japan, it is necessary to obtain approval to export such SHARP devices.
- This publication is the proprietary product of SHARP and is copyrighted, with all rights reserved. Under the copyright laws, no part of this publication may be reproduced or transmitted in any form or by any means, electronic or mechanical, for any purpose, in whole or in part, without the express written permission of SHARP. Express written permission is also required before any use of this publication may be made by a third party.
- Contact and consult with a SHARP representative if there are any questions about the contents of this publication.