

The PT7750 series is a +24V input, 15 Amp output, high-performance Integrated Switching Regulator (ISR) housed in a 27-pin SIP package. The 15A capability allows easy integration of the latest high-speed, low-voltage μ Ps and bus drivers into +24V distributed power systems.

The PT7750 series has been designed to work in parallel with one or

more of the PT7747 current boosters for increased I_{out} in increments of 15A.

The output voltage of the PT7750 series can be easily programmed over a wide range with a 5-bit input. A differential remote sense is provided which automatically compensates for any voltage drop from the ISR to the load.

2000 μ F of output capacitance is required for proper operation.

Standard Application

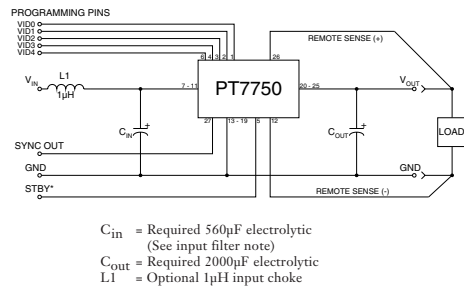

Pin-Out Information

Pin	Function	Pin	Function
1	VID0	14	GND
2	VID1	15	GND
3	VID2	16	GND
4	VID3	17	GND
5	STBY* - Stand-by	18	GND
6	VID4	19	GND
7	V_{in}	20	V_{out}
8	V_{in}	21	V_{out}
9	V_{in}	22	V_{out}
10	V_{in}	23	V_{out}
11	V_{in}	24	V_{out}
12	Remote Sense Gnd	25	V_{out}
13	GND	26	Remote Sense V_{out}
		27	Sync Out

For STBY* pin:
open = output enabled
ground = output disabled.

Features

- +24V bus input
- High Efficiency
- Differential Remote Sense
- 27-pin SIP Package
- Parallelable with PT7747 15A current boosters

Specifications

Characteristics ($T_a = 25^\circ\text{C}$ unless noted)	Symbols	Conditions	PT7750 SERIES			Units
			Min	Typ	Max	
Output Current	I_o	$T_a = +60^\circ\text{C}$, 200 LFM $T_a = +25^\circ\text{C}$, natural convection	0.1 (1)	—	15 (2)	A
Input Voltage Range	V_{in}	$0.1\text{A} \leq I_o \leq I_o \text{ max}$	20.0	—	28.0	V
Undervoltage Lockout Threshold	V_{uvl}	$0.1\text{A} \leq I_o \leq I_o \text{ max}$	—	18.7	—	V
Output Voltage Tolerance	ΔV_o	$V_{in} = +24\text{V}$, $I_o = 15\text{A}$ PT7751 $0^\circ\text{C} \leq T_a \leq +55^\circ\text{C}$ PT7756	—	—	± 80 ± 160	mV
Line Regulation	Reg_{line}	$20\text{V} \leq V_{in} \leq 28\text{V}$, $I_o = I_o \text{ max}$ (w/remote sense)	—	± 15	—	mV
Load Regulation	Reg_{load}	$V_{in} = +24\text{V}$, $0.1 \leq I_o \leq I_o \text{ max}$ (w/remote sense)	—	± 10	—	mV
V_o Ripple/Noise	V_n	$V_{in} = +24\text{V}$, $I_o = I_o \text{ max}$	—	75	—	mV
Transient Response with $C_{out} = 2000\mu\text{F}$	t_{rr} V_{os}	I_o step between 7.5A and 15A V_o over/undershoot	— —	100 200	— —	μSec mV
Efficiency	η	$V_{in} = +24\text{V}$, $I_o = 10\text{A}$	$V_o = 5.0\text{V}$ $V_o = 3.3\text{V}$ $V_o = 2.5\text{V}$	88 84 80	— — —	%
Switching Frequency	f_o	$20\text{V} \leq V_{in} \leq 28\text{V}$ $0.1\text{A} \leq I_o \leq 15\text{A}$	300	350	400	kHz
Absolute Maximum Operating Temperature Range	T_a	—	0	—	+85 (3)	$^\circ\text{C}$
Storage Temperature	T_s	—	-40	—	+125	$^\circ\text{C}$
Weight	—	Vertical/Horizontal	—	53/66	—	grams

- Notes**
- (1) ISR-will operate down to no load with reduced specifications. Please note that this product is not short-circuit protected.
 - (2) The PT7750 series can be easily paralleled with one or more of the PT7747 Current Boosters to provide increased output current in increments of 15A
 - (3) See safe operating area curves or contact the factory to determine the appropriate derating.

Output Capacitors: The PT7750 series requires a minimum output capacitance of 2000 μ F for proper operation. Do not use Oscon type capacitors. The maximum allowable output capacitance is (42,000 + V_{out}) μ F for the PT7751, (96,000 + V_{out}) μ F for the PT7756, or 15,000 μ F, whichever is less.

Input Filter: An input inductor is optional for most applications. The input inductor must be sized to handle 9ADC with a typical value of 1 μ H. The input capacitance must be rated for a minimum of 8.0 Arms of ripple current when operated at maximum output current and maximum output voltage. Contact an applications engineer for input capacitor selection for applications at other output voltages and output currents.

PT7750 Series

15 Amp 24V Input "Big Hammer III"
Programmable ISR

Programming Information

				PT7751		PT7756	
				VID4=1	VID4=0	VID4=1	VID4=0
VID3	VID2	VID1	VID0	Vout	Vout	Vout	Vout
1	1	1	1	2.5V	4.1V	6.6V	9.8V
1	1	1	0	2.6V	4.2V	6.8V	10.0V
1	1	0	1	2.7V	4.3V	7.0V	10.2V
1	1	0	0	2.8V	4.4V	7.2V	10.4V
1	0	1	1	2.9V	4.5V	7.4V	10.6V
1	0	1	0	3.0V	4.6V	7.6V	10.8V
1	0	0	1	3.1V	4.7V	7.8V	11.0V
1	0	0	0	3.2V	4.8V	8.0V	11.2V
0	1	1	1	3.3V	4.9V	8.2V	11.4V
0	1	1	0	3.4V	5.0V	8.4V	11.6V
0	1	0	1	3.5V	5.1V	8.6V	11.8V
0	1	0	0	3.6V	5.2V	8.8V	12.0V
0	0	1	1	3.7V	5.3V	9.0V	12.2V
0	0	1	0	3.8V	5.4V	9.2V	12.4V
0	0	0	1	3.9V	5.5V	9.4V	12.6V
0	0	0	0	4.0V	5.6V	9.6V	12.8V

Logic 0 = Pin 12 potential (remote sense gnd)
Logic 1 = Open circuit (no pull-up resistors)
VID3 and VID4 may not be changed while the unit is operating.

Ordering Information

PT7751□ = 2.5 to 5.6 Volts
PT7756□ = 6.6 to 12.8 Volts

(For dimensions and PC board layout, see Package Styles 1000 and 1010.)

PT Series Suffix (PT1234X)

Case/Pin

Configuration

Vertical Through-Hole	N
Horizontal Through-Hole	A
Horizontal Surface Mount	C

TYPICAL CHARACTERISTICS

Efficiency vs Output Current (@Vin=+24V)

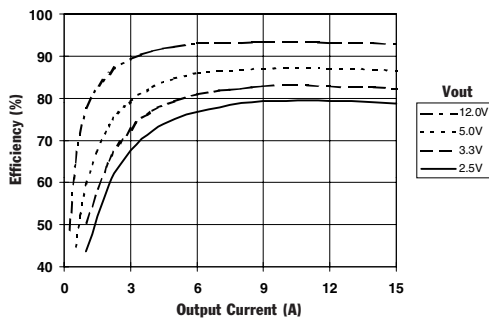

Output Ripple vs Output Current (@Vin=+24V)

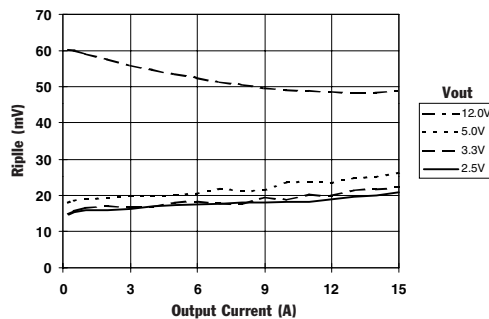

Power Dissipation vs Output Current (@Vin=+24V)

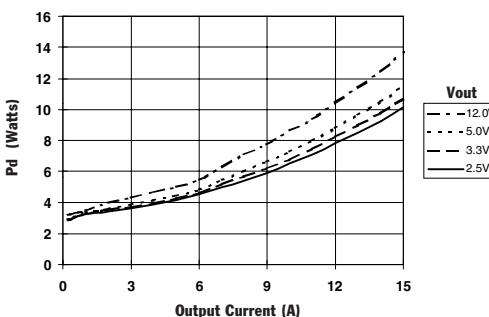

PT7751 Safe Operating Area (@Vin=+24V, Over V_o Range)

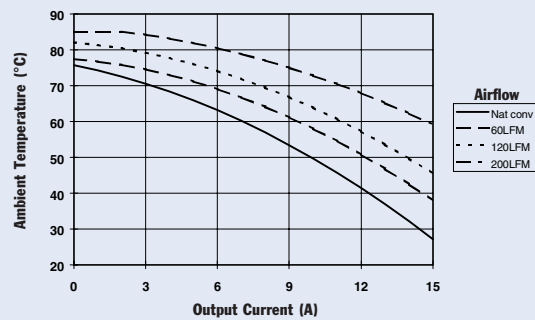

PT7756 Safe Operating Area (@Vin=+24V, Over V_o Range)

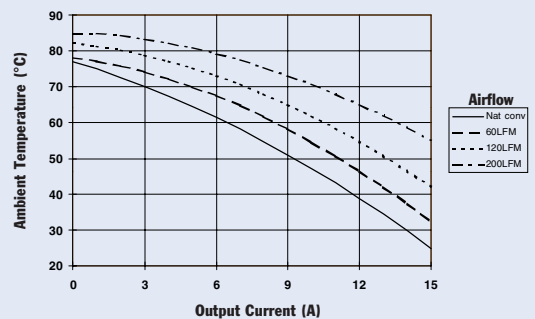

Note: SOA curves represent operating conditions at which internal components are at or below manufacturer's maximum rated operating temperatures.

Pin-Coded Output Voltage Adjustment on the “Big Hammer III” Series ISRs

Power Trends PT7750 series ISRs incorporating pin-coded voltage control, use pins 1, 2, 3, 4, & 6 to adjust the output voltage. The control pins are identified VID0 - VID4 respectively. When the control pins are left open-circuit, the ISR output will regulate at its factory trimmed output voltage. Each control pin is internally connected to a precision resistor, and when grounded increases the output voltage by a set amount. The internal resistors are binary code weighted, allowing the output voltage of the ISR to be programmed as a function of a binary code. VID0 represents the LSB, and VID4 the MSB (or range change bit). The output voltage ranges offered by these regulators are compatible with some microprocessors, and provide a convenient method of output voltage selection for many other applications. Refer to Figure 1 below for the connection schematic, and the PT7750 Data Sheet for the programming code information.

Notes:

- The programming convention is as follows:-
 - Logic 0: Connect to pin12 (Remote Sense Ground).
 - Logic 1: Open circuit/open drain (See notes 2, & 4)
- Do not connect pull-up resistors to the voltage programming pins.
- To minimize output voltage error, always use pin 12 (Remote Sense Ground) as the logic “0” reference. While the regular ground (pins 13-19) can also be used for programming, doing so will degrade the load regulation of the product.
- If active devices are used to ground the voltage control

pins, low-level open drain MOSFET devices should be used over bipolar transistors. The inherent $V_{ce(sat)}$ in bipolar devices introduces errors in the device's internal divider network. Discrete transistors such as the BSS138, 2N7002, IRLML2402, or the 74C906 hex open-drain buffer are examples of appropriate devices.

Active Voltage Programming:

Special precautions should be taken when making changes to the voltage control program code while the unit is powered. It is highly recommended that the ISR be either powered down or in standby. Changes made to the program code while V_{out} is enabled induces high current transients through the device. This is the result of the electrolytic output capacitors being either charged or discharged to the new output voltage set-point. The transient current can be minimized by making only incremental changes to the binary code, i.e. one LSB at a time. A minimum of 100 μ s settling time between each program state is also recommended. Making non-incremental changes to VID3 and VID4 with the output enabled is discouraged. If they are changed, the transients induced can overstress the device resulting in a permanent drop in efficiency. If the use of active devices prevents the program code being asserted prior to power-up, pull pin 5 (STBY) to the device GND during the period that the input voltage is applied to V_{in} . Releasing pin 5 will then allow the device output to execute a soft-start power-up to the programmed voltage. For more information on the use of the Standby function, consult the related application note, “Using the Standby Function on the ‘Big Hammer III’ Programmable ISR Series.”

Figure 1

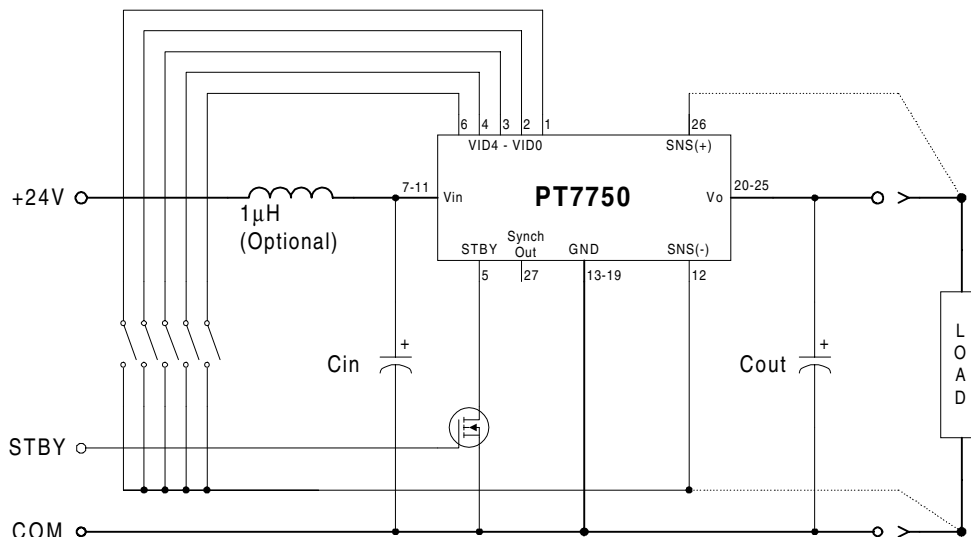

Using the Standby Function on the PT7750 “Big Hammer III” Programmable ISRs

For applications requiring output voltage On/Off control, the PT7750 “Big Hammer” ISRs incorporate a standby function¹. This feature may be used for power-up/shut-down sequencing, and to change the output voltage while input power is applied. *See related notes:* “Pin-coded Output Voltage Adjustment on the ‘Big Hammer III’ Series ISRs.”

The standby function is provided by the *STBY** control, pin 5. If pin 5 is left open-circuit the regulator operates normally, providing a regulated output whenever a valid supply voltage is applied to V_{in} (pins 7-11) with respect to GND (pins 13-19). Connecting pin 5 to ground² will set the regulator output to zero volts³. This places the regulator in standby mode, and reduces the input current to typically 30mA (50mA max). If a ground signal is applied to pin 5 prior to power-up, the regulator output will be held at zero volts during the period that input power is applied.

The standby input must be controlled with an open-collector (or open-drain) discrete transistor (See Figure 1). Table 1 gives the threshold requirements.

Table 1 Inhibit Control Threshold²

Parameter	Min	Max
Disable (V_{IL})	-0.1V	0.3V

Notes:

1. The Standby/Inhibit control logic is similar for all Power Trends’ modules, but the flexibility and threshold tolerances will be different. For specific information on this function for other regulator models, consult the applicable application note.
2. The Standby input on the PT7750 regulator series must be controlled using an open-collector (or open-drain) discrete transistor. *Do Not* use a pull-up resistor. The control input has an open-circuit voltage of about 1.5Vdc. To set the regulator output to zero, the control pin must be “pulled” to less than 0.3Vdc with a low-level 0.1mA sink to ground.
3. When placed in the standby mode, the regulator output discharges the output capacitance with a low impedance to ground. If an external voltage is applied to the output, it will sink current and possibly over-stress the part.
4. The turn-off time of Q_1 , or rise time of the standby input is not critical on the PT7750 series. Turning Q_1 off slowly, over periods up to 100ms, will not affect regulator operation. However, a slow turn-off time will increase both the initial delay and rise-time of the output voltage.

Figure 1

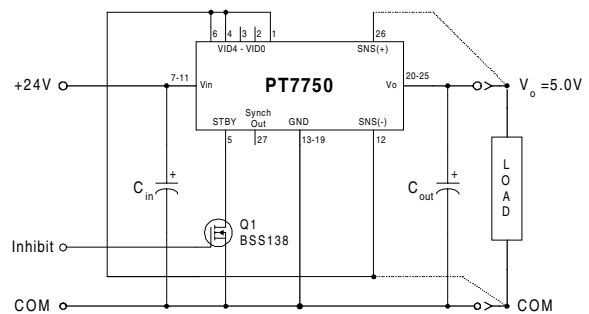

Turn-On Time: Turning Q_1 in Figure 1 off, removes the low-voltage signal at pin 5 and enables the output. Following a brief delay of 8-18ms, the output voltage of the PT7750 series regulators rise to full regulation within 20ms⁴. Figure 2 shows the typical output voltage waveform of a PT7751 following the prompt turn-off of Q_1 at time $t=0$ secs. The output voltage in Figure 1 is set to 5.0V by connecting VID0 (pin 1), VID3 (pin 4), and VID4 (pin 6) to the Remote Sense Gnd (pin 12)⁴. The waveform in Figure 2 was measured with a 24V input source voltage, and 10A resistive load.

Figure 2

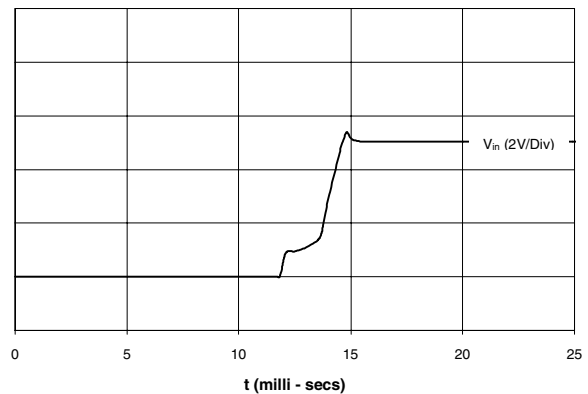

⁴ Consult the data sheet for details on other VID codes.

PACKAGING INFORMATION

Orderable Device	Status (1)	Package Type	Package Drawing	Pins	Package Qty	Eco Plan (2)	Lead/Ball Finish	MSL Peak Temp (3)	Samples (Requires Login)
PT7751A	OBSOLETE	SIP MODULE	EJF	27		TBD	Call TI	Call TI	
PT7751N	LIFEBUY	SIP MODULE	EJE	27	8	TBD	Call TI	Level-1-215C-UNLIM	
PT7756A	LIFEBUY	SIP MODULE	EJF	27	6	TBD	Call TI	Level-1-215C-UNLIM	
PT7756C	LIFEBUY	SIP MODULE	EJG	27	6	TBD	Call TI	Level-1-215C-UNLIM	

(1) The marketing status values are defined as follows:

ACTIVE: Product device recommended for new designs.

LIFEBUY: TI has announced that the device will be discontinued, and a lifetime-buy period is in effect.

NRND: Not recommended for new designs. Device is in production to support existing customers, but TI does not recommend using this part in a new design.

PREVIEW: Device has been announced but is not in production. Samples may or may not be available.

OBSOLETE: TI has discontinued the production of the device.

(2) Eco Plan - The planned eco-friendly classification: Pb-Free (RoHS), Pb-Free (RoHS Exempt), or Green (RoHS & no Sb/Br) - please check <http://www.ti.com/productcontent> for the latest availability information and additional product content details.

TBD: The Pb-Free/Green conversion plan has not been defined.

Pb-Free (RoHS): TI's terms "Lead-Free" or "Pb-Free" mean semiconductor products that are compatible with the current RoHS requirements for all 6 substances, including the requirement that lead not exceed 0.1% by weight in homogeneous materials. Where designed to be soldered at high temperatures, TI Pb-Free products are suitable for use in specified lead-free processes.

Pb-Free (RoHS Exempt): This component has a RoHS exemption for either 1) lead-based flip-chip solder bumps used between the die and package, or 2) lead-based die adhesive used between the die and leadframe. The component is otherwise considered Pb-Free (RoHS compatible) as defined above.

Green (RoHS & no Sb/Br): TI defines "Green" to mean Pb-Free (RoHS compatible), and free of Bromine (Br) and Antimony (Sb) based flame retardants (Br or Sb do not exceed 0.1% by weight in homogeneous material)

(3) MSL, Peak Temp. -- The Moisture Sensitivity Level rating according to the JEDEC industry standard classifications, and peak solder temperature.

Important Information and Disclaimer: The information provided on this page represents TI's knowledge and belief as of the date that it is provided. TI bases its knowledge and belief on information provided by third parties, and makes no representation or warranty as to the accuracy of such information. Efforts are underway to better integrate information from third parties. TI has taken and continues to take reasonable steps to provide representative and accurate information but may not have conducted destructive testing or chemical analysis on incoming materials and chemicals. TI and TI suppliers consider certain information to be proprietary, and thus CAS numbers and other limited information may not be available for release.

In no event shall TI's liability arising out of such information exceed the total purchase price of the TI part(s) at issue in this document sold by TI to Customer on an annual basis.

IMPORTANT NOTICE

Texas Instruments Incorporated and its subsidiaries (TI) reserve the right to make corrections, enhancements, improvements and other changes to its semiconductor products and services per JESD46, latest issue, and to discontinue any product or service per JESD48, latest issue. Buyers should obtain the latest relevant information before placing orders and should verify that such information is current and complete. All semiconductor products (also referred to herein as "components") are sold subject to TI's terms and conditions of sale supplied at the time of order acknowledgment.

TI warrants performance of its components to the specifications applicable at the time of sale, in accordance with the warranty in TI's terms and conditions of sale of semiconductor products. Testing and other quality control techniques are used to the extent TI deems necessary to support this warranty. Except where mandated by applicable law, testing of all parameters of each component is not necessarily performed.

TI assumes no liability for applications assistance or the design of Buyers' products. Buyers are responsible for their products and applications using TI components. To minimize the risks associated with Buyers' products and applications, Buyers should provide adequate design and operating safeguards.

TI does not warrant or represent that any license, either express or implied, is granted under any patent right, copyright, mask work right, or other intellectual property right relating to any combination, machine, or process in which TI components or services are used. Information published by TI regarding third-party products or services does not constitute a license to use such products or services or a warranty or endorsement thereof. Use of such information may require a license from a third party under the patents or other intellectual property of the third party, or a license from TI under the patents or other intellectual property of TI.

Reproduction of significant portions of TI information in TI data books or data sheets is permissible only if reproduction is without alteration and is accompanied by all associated warranties, conditions, limitations, and notices. TI is not responsible or liable for such altered documentation. Information of third parties may be subject to additional restrictions.

Resale of TI components or services with statements different from or beyond the parameters stated by TI for that component or service voids all express and any implied warranties for the associated TI component or service and is an unfair and deceptive business practice. TI is not responsible or liable for any such statements.

Buyer acknowledges and agrees that it is solely responsible for compliance with all legal, regulatory and safety-related requirements concerning its products, and any use of TI components in its applications, notwithstanding any applications-related information or support that may be provided by TI. Buyer represents and agrees that it has all the necessary expertise to create and implement safeguards which anticipate dangerous consequences of failures, monitor failures and their consequences, lessen the likelihood of failures that might cause harm and take appropriate remedial actions. Buyer will fully indemnify TI and its representatives against any damages arising out of the use of any TI components in safety-critical applications.

In some cases, TI components may be promoted specifically to facilitate safety-related applications. With such components, TI's goal is to help enable customers to design and create their own end-product solutions that meet applicable functional safety standards and requirements. Nonetheless, such components are subject to these terms.

No TI components are authorized for use in FDA Class III (or similar life-critical medical equipment) unless authorized officers of the parties have executed a special agreement specifically governing such use.

Only those TI components which TI has specifically designated as military grade or "enhanced plastic" are designed and intended for use in military/aerospace applications or environments. Buyer acknowledges and agrees that any military or aerospace use of TI components which have **not** been so designated is solely at the Buyer's risk, and that Buyer is solely responsible for compliance with all legal and regulatory requirements in connection with such use.

TI has specifically designated certain components as meeting ISO/TS16949 requirements, mainly for automotive use. In any case of use of non-designated products, TI will not be responsible for any failure to meet ISO/TS16949.

Products

Audio	www.ti.com/audio
Amplifiers	amplifier.ti.com
Data Converters	dataconverter.ti.com
DLP® Products	www.dlp.com
DSP	dsp.ti.com
Clocks and Timers	www.ti.com/clocks
Interface	interface.ti.com
Logic	logic.ti.com
Power Mgmt	power.ti.com
Microcontrollers	microcontroller.ti.com
RFID	www.ti-rfid.com
OMAP Applications Processors	www.ti.com/omap
Wireless Connectivity	www.ti.com/wirelessconnectivity

Applications

Automotive and Transportation	www.ti.com/automotive
Communications and Telecom	www.ti.com/communications
Computers and Peripherals	www.ti.com/computers
Consumer Electronics	www.ti.com/consumer-apps
Energy and Lighting	www.ti.com/energy
Industrial	www.ti.com/industrial
Medical	www.ti.com/medical
Security	www.ti.com/security
Space, Avionics and Defense	www.ti.com/space-avionics-defense
Video and Imaging	www.ti.com/video

TI E2E Community

e2e.ti.com