

404-810



**G E C P L E S S E Y**  
**S E M I C O N D U C T O R S**

SL1611 IS FOR MAINTENANCE PURPOSES ONLY AND IS NOT RECOMMENDED FOR NEW DESIGNS

**SL1610, SL1611, SL1612**  
**RF/IF AMPLIFIERS**

The SL1610C, SL1611C and SL1612C are RF voltage amplifiers with AGC facilities. The voltage gains are 10, 20 and 50 times respectively and the upper frequency response varies from 15 MHz to 120 MHz according to type.

**FEATURES**

- Wide AGC Range: 50dB
- Easy Interfacing
- Integral Power Supply RF Decoupling

**APPLICATIONS**

- RF Amplifiers
- IF Amplifiers

**QUICK REFERENCE DATA**

- Supply Voltage 6V
- Voltage Gain 20dB to 34dB

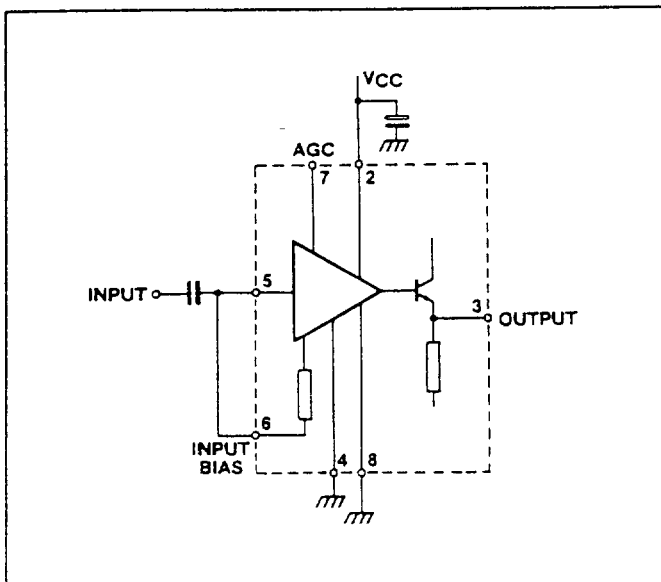

Fig 2 Block diagram

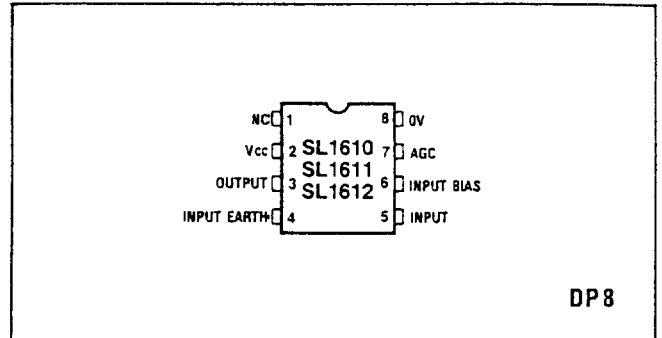

Fig 1 Pin connections (top view)

**ABSOLUTE MAXIMUM RATINGS**

Supply voltage 12V  
Storage temperature  $-55^{\circ}\text{C}$  to  $+125^{\circ}\text{C}$

**ORDERING INFORMATION**

SL1610/1/2 C DP

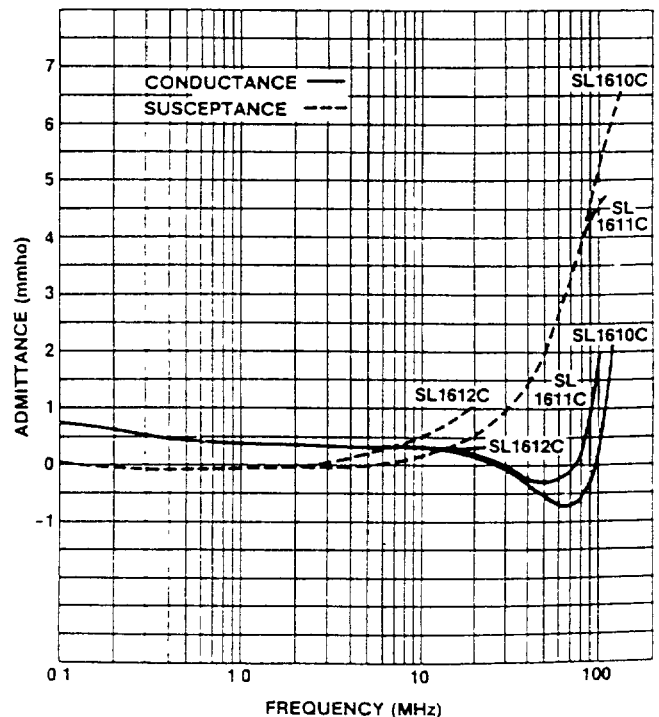

Fig 3 Input admittance with o/c output ( $G_{11}$ )

# SL1610/1611/1612

## ELECTRICAL CHARACTERISTICS

Test conditions (unless otherwise stated):

Supply voltage  $V_{CC}$  6V  
 Ambient temperature  $-30^{\circ}\text{C}$  to  $+85^{\circ}\text{C}$   
 Test frequency SL1610C 30MHz  
 SL1611C 30MHz  
 SL1612C 1.75MHz

Characteristics	Circuit	Value			Units	Conditions
		Min.	Typ.	Max.		
Supply current	SL1610C		15	24	mA	No signal, pin 3 open circuit
	SL1611C		15	24	mA	
	SL1612C		3.3	6	mA	
Voltage gain	SL1610C	17	20	24	dB	$R_s = 50\Omega$ $R_L = 500\Omega$ $T_{amb} = 22^{\circ}\text{C}$
	SL1611C	23	26	30	dB	
	SL1612C	31	34	38	dB	
Cut-off frequency (-3dB)	SL1610C		120		MHz	$R_L = 150\Omega$ (SL1610C/1611C) $R_L = 1.2k\Omega$ (SL1612C)
	SL1611C		80		MHz	
	SL1612C		15		MHz	
Max. output signal (max AGC)			1.0		V rms	$R_L = 150\Omega$ (SL1610C/1611C) $R_L = 1.2k\Omega$ (SL1612C)
Max. input signal (max AGC)			250		mV rms	
AGC range	SL1610C	40	50		dB	Pin 7 0V to 5.1V
	SL1611C	40	50		dB	
	SL1612C	60	70		dB	
AGC current			0.15	0.6	mA	Current into pin 7 at 5.1V

## APPLICATION NOTES

### Input circuit

The SL1610C, SL1611C and SL1612C are normally used with pins 5 and 6 connected together and with the input connected via a capacitor as shown in Fig 2

The input impedance is negative between 30MHz and 100MHz (SL1610C, SL1611C only) and is shown in Fig 3. the source is inductive it should be shunted by a  $1k\Omega$  resistor to prevent oscillation

An alternative input circuit with improved noise figure is shown in Fig 4

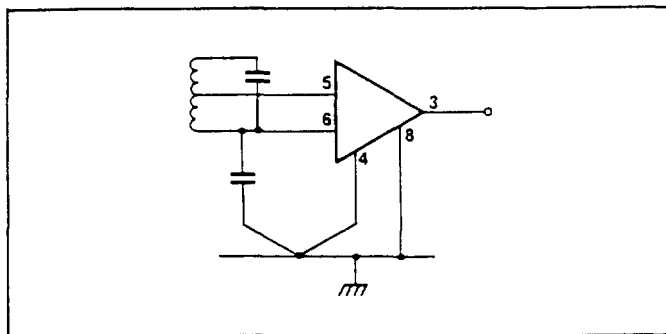

Fig 4 Alternative input circuit

### Output circuit

The output stage is an emitter follower and has a negative output impedance at certain frequencies as shown in Fig 5

To prevent oscillation when the load is capacitive a  $47\Omega$  resistor should be connected in series with the output

## AGC

When pin 7 is open circuit or connected to a voltage less than 2V the voltage gain is normal. As the AGC voltage is increased there is a reduction in gain as shown in Fig 6. This reduction varies with temperature

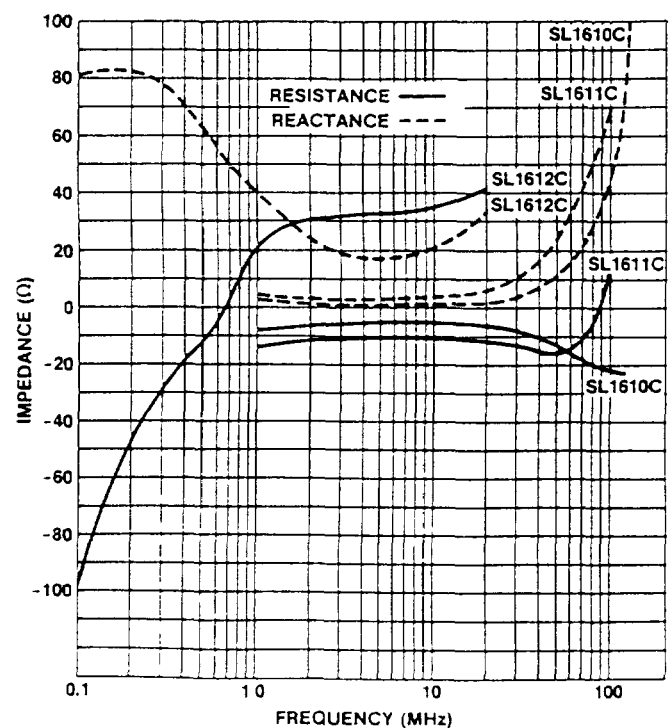

Fig 5 Typical output impedance with s/c input (G22)

Typical applications

The circuit of Fig. 7 is a general purpose RF preamplifier. The voltage gain (from pin 5 to pin 3) is shown in Fig. 8. Fig. 9 is the IF section of a simple SSB transceiver. At 9MHz it has a gain of 100dB.

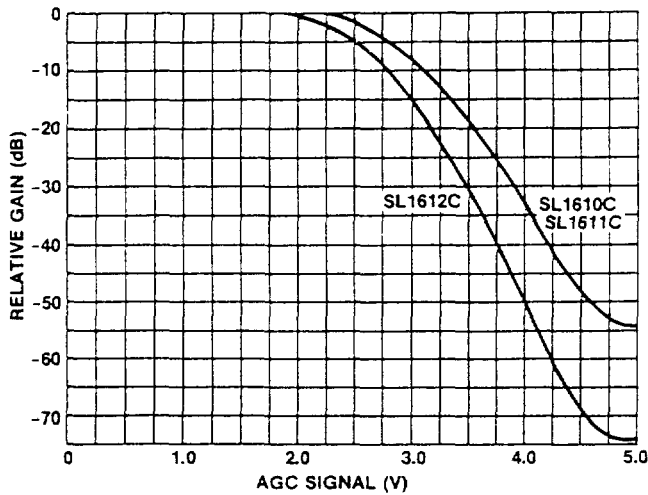

Fig. 6 AGC characteristics (typical)

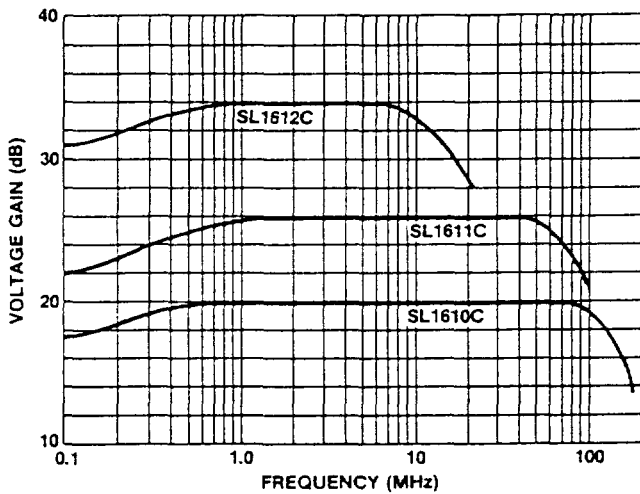

Fig. 8 Typical voltage gain ( $R_s=50\Omega$ )

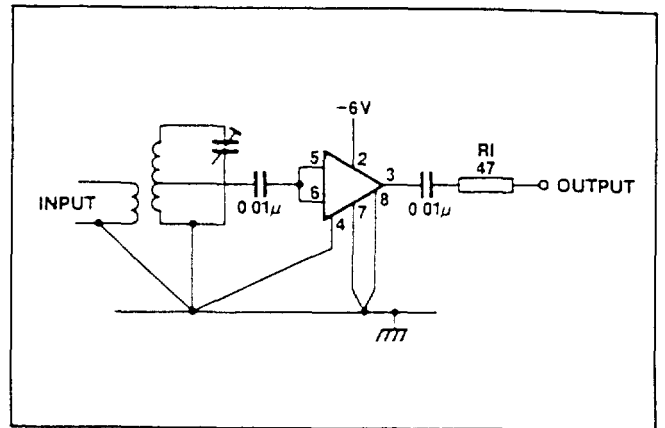

Fig. 7 RF preamplifier

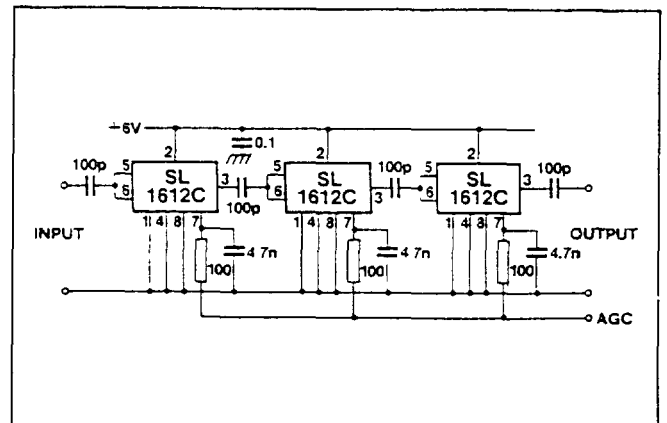

Fig. 9 IF amplifier using SL1612