

5 MHz, Low Noise, RRO, Dual Operational Amplifier with CMOS Input

Check for Samples: [SM73303](#)

FEATURES

- (Typical values, $V^+ = 3.3V$, $T_A = 25^\circ C$, unless otherwise specified)
- Input noise voltage $12.8 \text{ nV}/\sqrt{\text{Hz}}$
- Input bias current 0.6 pA
- Offset voltage 1.6 mV
- CMRR 80 dB
- Open loop gain 122 dB
- Rail-to-rail output
- GBW 5 MHz
- Slew rate $5.8 \text{ V}/\mu\text{s}$
- Supply current 1.6 mA
- Supply voltage range $2.7V$ to $5V$

- Operating temperature $-40^\circ C$ to $85^\circ C$
- 8-pin MSOP package

APPLICATIONS

- Active filters
- Transimpedance amplifiers
- Audio preamp
- HDD vibration cancellation circuitry



DESCRIPTION

The SM73303 is a dual operational amplifier with both low supply voltage and low supply current, making it ideal for portable applications. The SM73303 CMOS input stage drives the I_{BIAS} current down to 0.6 pA ; this coupled with the low noise voltage of $12.8 \text{ nV}/\sqrt{\text{Hz}}$ makes the SM73303 perfect for applications requiring active filters, transimpedance amplifiers, and HDD vibration cancellation circuitry.

Along with great noise sensitivity, small signal applications will benefit from the large gain bandwidth of 5 MHz coupled with the minimal supply current of 1.6 mA and a slew rate of $5.8 \text{ V}/\mu\text{s}$.

The SM73303 provides rail-to-rail output swing into heavy loads. The input common-mode voltage range includes ground, which is ideal for ground sensing applications.

The SM73303 has a supply voltage spanning $2.7V$ to $5V$ and is offered in an 8-pin MSOP package that functions across the wide temperature range of $-40^\circ C$ to $85^\circ C$. This small package makes it possible to place the SM73303 next to sensors, thus reducing external noise pickup.

Typical Application Circuit

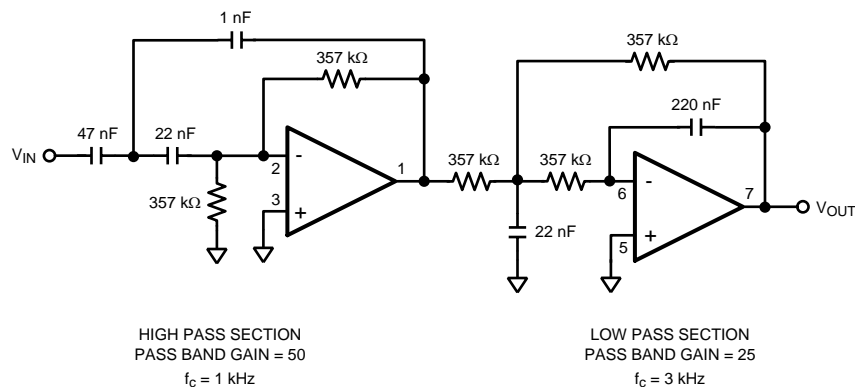

Figure 1. High Gain Band Pass Filter



Please be aware that an important notice concerning availability, standard warranty, and use in critical applications of Texas Instruments semiconductor products and disclaimers thereto appears at the end of this data sheet.

All trademarks are the property of their respective owners.



These devices have limited built-in ESD protection. The leads should be shorted together or the device placed in conductive foam during storage or handling to prevent electrostatic damage to the MOS gates.

Absolute Maximum Ratings ⁽¹⁾

ESD Tolerance ⁽²⁾	
Human Body Model	2000V
Machine Model	200V
Supply Voltage (V ⁺ – V ⁻)	5.5V
Storage Temperature Range	-65°C to 150°C
Junction Temperature ⁽³⁾	150°C max
Mounting Temperature	
Infrared or Convection (20 sec)	260°C

- (1) Absolute Maximum Ratings indicate limits beyond which damage to the device may occur. Operating Ratings indicate conditions for which the device is intended to be functional, but specific performance is not guaranteed. For guaranteed specifications and the test conditions, see the Electrical Characteristics.
- (2) Human Body Model is 1.5 kΩ in series with 100 pF. Machine Model is 0Ω in series with 100 pF.
- (3) The maximum power dissipation is a function of T_{J(MAX)}, θ_{JA} and T_A. The maximum allowable power dissipation at any ambient temperature is P_D = (T_{J(MAX)}-T_A)/θ_{JA}. All numbers apply for packages soldered directly into a PC board.

Operating Ratings ⁽¹⁾

Supply Voltage	2.7V to 5V
Temperature Range	-40°C to 85°C
Thermal Resistance (θ _{JA})	
8-Pin MSOP	195°C/W

- (1) Absolute Maximum Ratings indicate limits beyond which damage to the device may occur. Operating Ratings indicate conditions for which the device is intended to be functional, but specific performance is not guaranteed. For guaranteed specifications and the test conditions, see the Electrical Characteristics.

3.3V Electrical Characteristics ⁽¹⁾

Unless otherwise specified, all limits are guaranteed for $T_J = 25^\circ\text{C}$, $V^+ = 3.3\text{V}$, $V^- = 0\text{V}$. $V_{CM} = V^+/2$. **Boldface** limits apply at the temperature extremes ⁽²⁾.

Symbol	Parameter	Condition	Min (3)	Typ (4)	Max (3)	Units
V_{OS}	Input Offset Voltage	$V_{CM} = 1\text{V}$		1.6	5 6	mV
I_B	Input Bias Current	⁽⁵⁾		0.6	115 130	pA
I_{OS}	Input Offset Current			1		pA
CMRR	Common Mode Rejection Ratio	$0 \leq V_{CM} \leq 2.1\text{V}$	60 50	80		dB
PSRR	Power Supply Rejection Ratio	$2.7\text{V} \leq V^+ \leq 5\text{V}$, $V_{CM} = 1\text{V}$	70 60	82		dB
CMVR	Common Mode Voltage Range	For CMRR ≥ 50 dB	-0.2		2.2	V
A_{VOL}	Open Loop Voltage Gain	Sourcing $R_L = 10\text{ k}\Omega$ to $V^+/2$, $V_O = 1.65\text{V}$ to 2.9V	80 76	122		dB
		Sinking $R_L = 10\text{ k}\Omega$ to $V^+/2$, $V_O = 0.4\text{V}$ to 1.65V	80 76	122		
		Sourcing $R_L = 600\Omega$ to $V^+/2$, $V_O = 1.65\text{V}$ to 2.8V	80 76	105		
		Sinking $R_L = 600\Omega$ to $V^+/2$, $V_O = 0.5\text{V}$ to 1.65V	80 76	112		
V_O	Output Swing High	$R_L = 10\text{ k}\Omega$ to $V^+/2$	3.22 3.17	3.29		V
		$R_L = 600\Omega$ to $V^+/2$	3.12 3.07	3.22		
	Output Swing Low	$R_L = 10\text{ k}\Omega$ to $V^+/2$		0.03	0.12 0.16	
		$R_L = 600\Omega$ to $V^+/2$		0.07	0.23 0.27	
I_{OUT}	Output Current	Sourcing, $V_O = 0\text{V}$	20 15	31		mA
		Sinking, $V_O = 3.3\text{V}$	30 25	41		
I_S	Supply Current	$V_{CM} = 1\text{V}$		1.6	2.0 3	mA
SR	Slew Rate	⁽⁶⁾		5.8		V/ μs
GBW	Gain Bandwidth			5		MHz
e_n	Input-Referred Voltage Noise	$f = 1\text{ kHz}$		12.8		nV/ $\sqrt{\text{Hz}}$
i_n	Input-Referred Current Noise	$f = 1\text{ kHz}$		0.01		pA/ $\sqrt{\text{Hz}}$

- (1) Electrical Table values apply only for factory testing conditions at the temperature indicated. Factor testing conditions result in very limited self-heating of the device such that $T_J = T_A$. No guarantee of parametric performance is indicated in the electrical tables under conditions of internal self-heating where $T_J > T_A$. Absolute Maximum Ratings indicate junction temperature limits beyond which the device may be permanently degraded, either mechanically or electrically.
- (2) Boldface limits apply to temperature range of -40°C to 85°C .
- (3) All limits are guaranteed by testing or statistical analysis.
- (4) Typical values represent the most likely parametric norm.
- (5) Input bias current is guaranteed by design.
- (6) Number specified is the lower of the positive and negative slew rates.

Connection Diagram

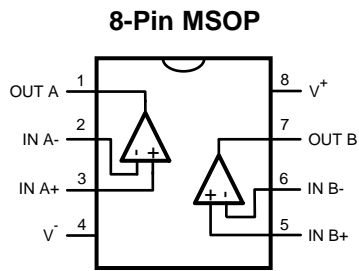
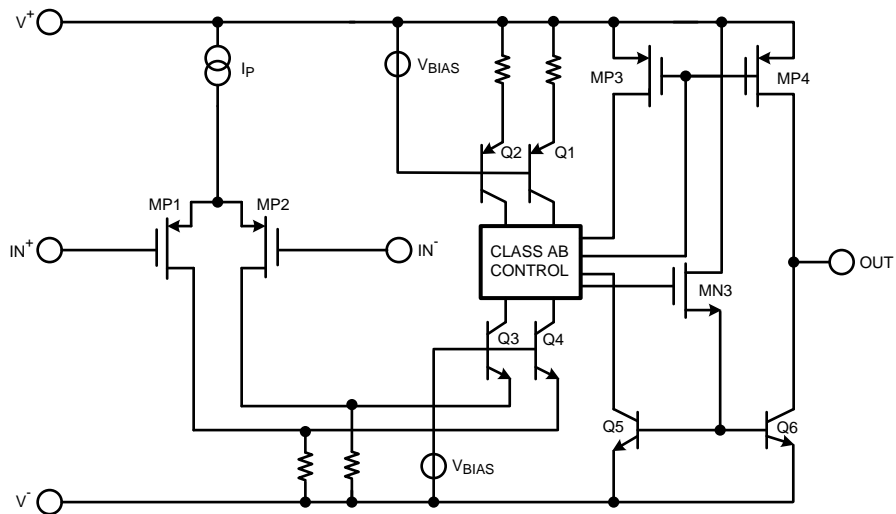

Figure 2. Top View

Simplified Schematic



Typical Performance Characteristics

Unless otherwise specified, $V^+ = 3.3V$, $T_J = 25^\circ C$.

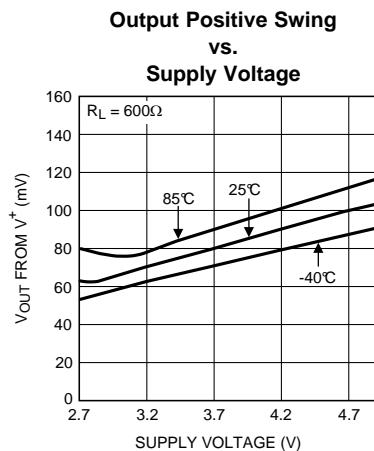
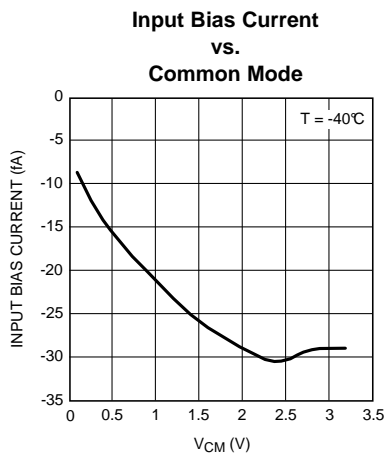
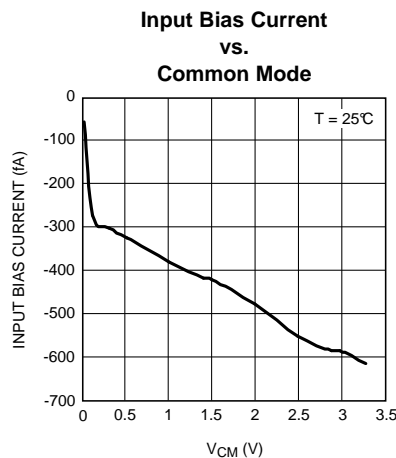
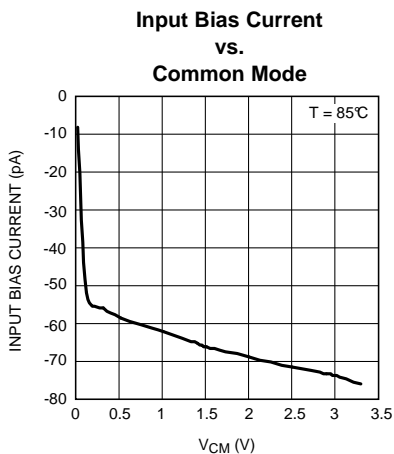
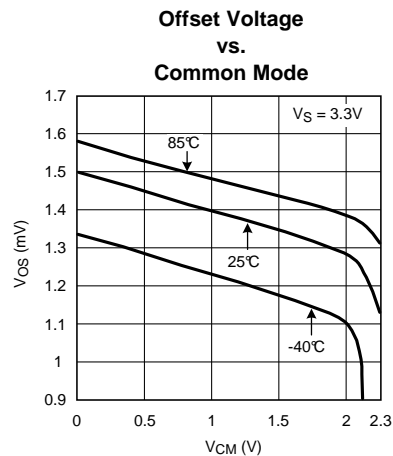
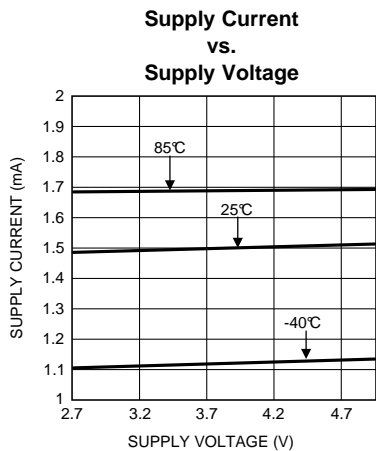

Typical Performance Characteristics (continued)

Unless otherwise specified, $V^+ = 3.3V$, $T_J = 25^\circ C$.

Output Negative Swing vs. Supply Voltage

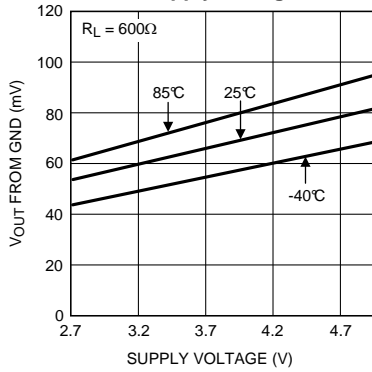

Output Positive Swing vs. Supply Voltage

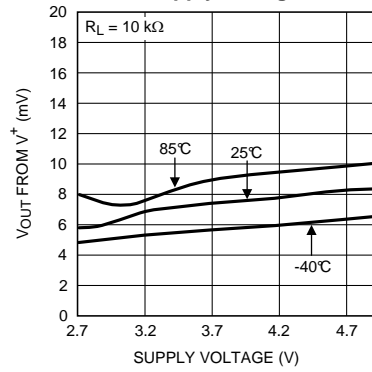

Output Negative Swing vs. Supply Voltage

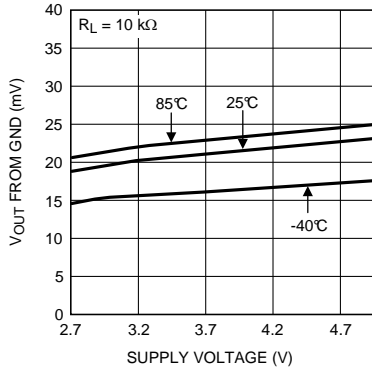

Sinking Current vs. VOUT

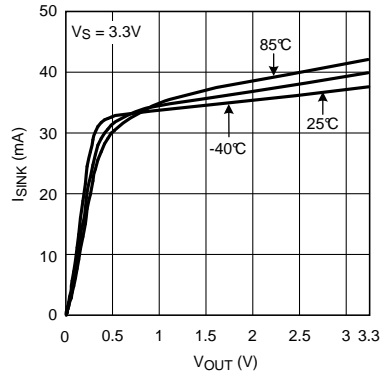

Sourcing Current vs. VOUT

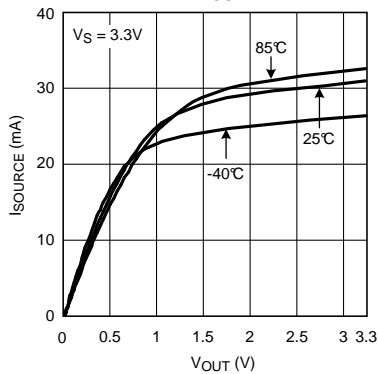

PSRR vs. Frequency

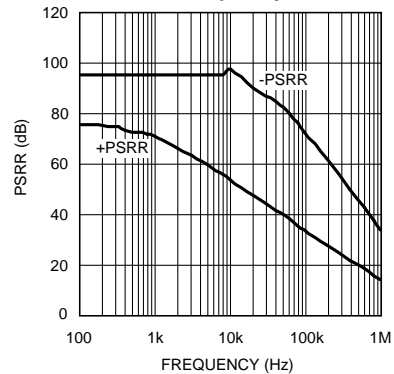

Typical Performance Characteristics (continued)

Unless otherwise specified, $V^+ = 3.3V$, $T_J = 25^\circ C$.

CMRR vs. Frequency

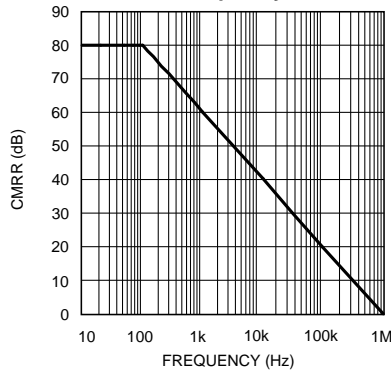

Crosstalk Rejection

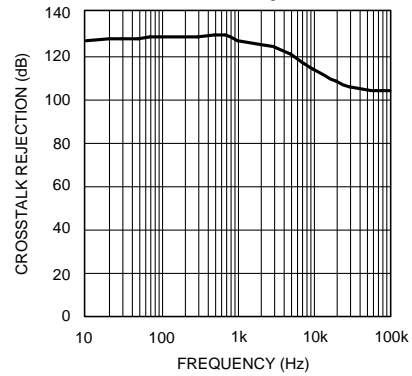

Inverting Large Signal Pulse Response

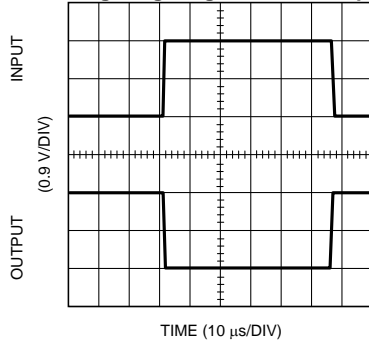

Inverting Small Signal Pulse Response

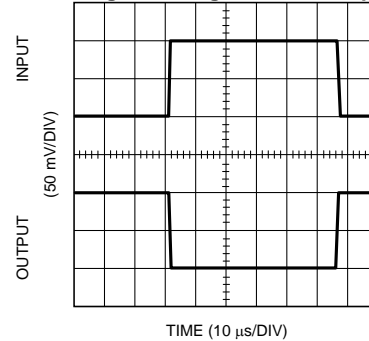

Non-Inverting Large Signal Pulse Response

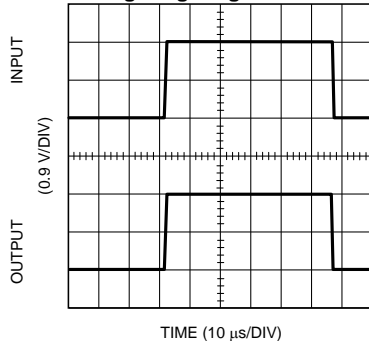

Non-Inverting Small Signal Pulse Response

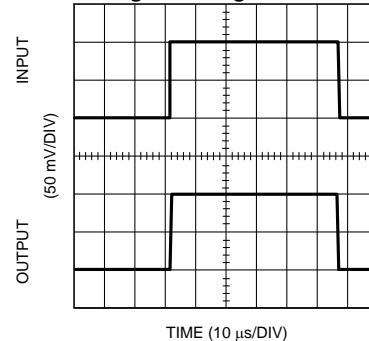

Open Loop Frequency vs. R_L

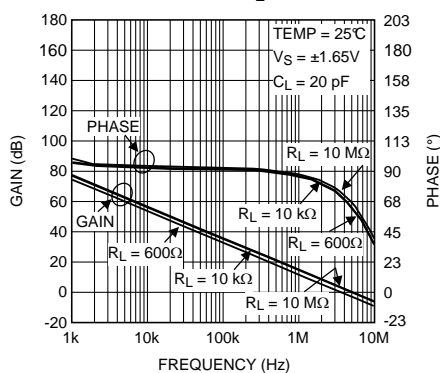

Open Loop Frequency Response over Temperature

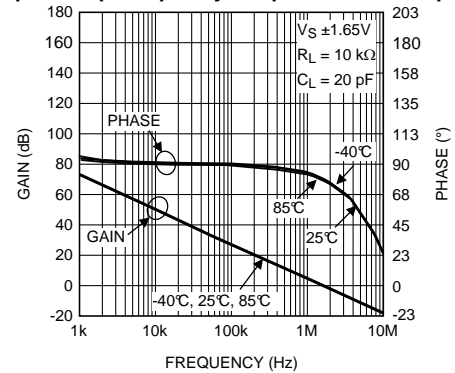

Typical Performance Characteristics (continued)

Unless otherwise specified, $V^+ = 3.3V$, $T_J = 25^\circ C$.

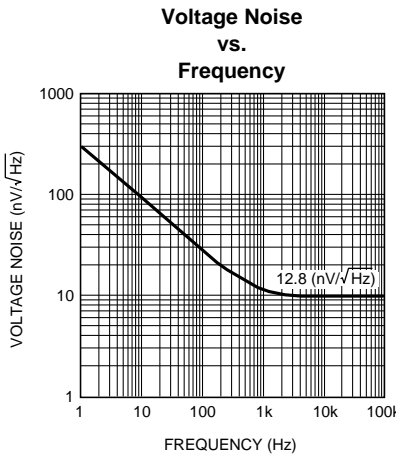
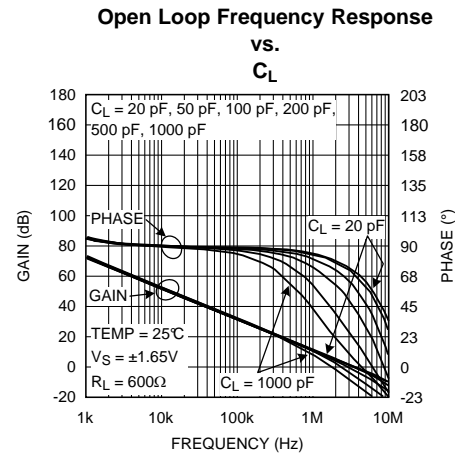
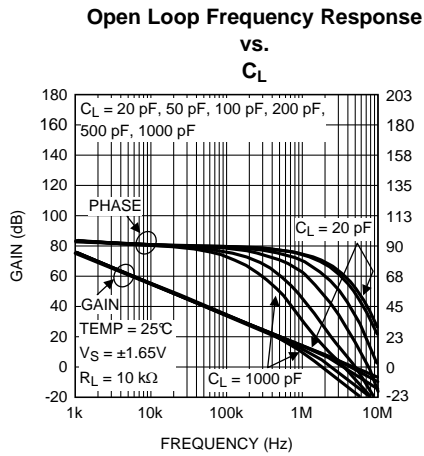

Application Information

With the low supply current of only 1.6 mA, the SM73303 offers users the ability to maximize battery life. This makes the SM73303 ideal for battery powered systems. The SM73303’s rail-to-rail output swing provides the maximum possible dynamic range at the output. This is particularly important when operating on low supply voltages.

CAPACITIVE LOAD TOLERANCE

The SM73303, when in a unity-gain configuration, can directly drive large capacitive loads in unity-gain without oscillation. The unity-gain follower is the most sensitive configuration to capacitive loading; direct capacitive loading reduces the phase margin of amplifiers. The combination of the amplifier’s output impedance and the capacitive load induces phase lag. This results in either an underdamped pulse response or oscillation. To drive a heavier capacitive load, the circuit in [Figure 3](#) can be used.

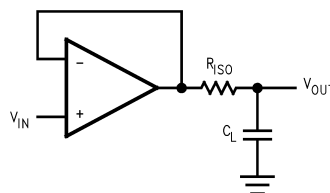

Figure 3. Indirectly Driving a Capacitive Load using Resistive Isolation

In Figure 3, the isolation resistor R_{ISO} and the load capacitor C_L form a pole to increase stability by adding more phase margin to the overall system. The desired performance depends on the value of R_{ISO} . The bigger the R_{ISO} resistor value, the more stable V_{OUT} will be.

The circuit in Figure 4 is an improvement to the one in Figure 3 because it provides DC accuracy as well as AC stability. If there were a load resistor in Figure 3, the output would be voltage divided by R_{ISO} and the load resistor. Instead, in Figure 4, R_F provides the DC accuracy by using feed-forward techniques to connect V_{IN} to R_L . Due to the input bias current of the SM73303, the designer must be cautious when choosing the value of R_F . C_F and R_{ISO} serve to counteract the loss of phase margin by feeding the high frequency component of the output signal back to the amplifier's inverting input, thereby preserving phase margin in the overall feedback loop. Increased capacitive drive is possible by increasing the value of C_F . This in turn will slow down the pulse response.

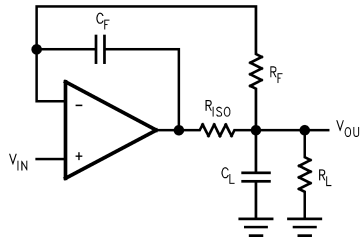

Figure 4. Indirectly Driving a Capacitive Load with DC Accuracy

DIFFERENCE AMPLIFIER

The difference amplifier allows the subtraction of two voltages or, as a special case, the cancellation of a signal common to two inputs. It is useful as a computational amplifier in making a differential to single-ended conversion or in rejecting a common mode signal.

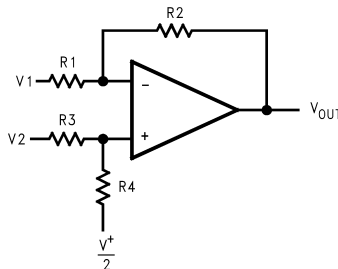

Figure 5. Difference Amplifier

$$V_{OUT} = \left(\frac{R1 + R2}{R3 + R4}\right) \frac{R4}{R1} V_2 - \frac{R2}{R1} V_1 + \left(\frac{R1 + R2}{R3 + R4}\right) \frac{R3}{R1} \cdot \frac{V^*}{2}$$

$$\text{for } R1 = R3 \text{ and } R2 = R4$$

$$V_{OUT} = \frac{R2}{R1} (V_2 - V_1) + \frac{V^*}{2}$$

(1)

SINGLE-SUPPLY INVERTING AMPLIFIER

There may be cases where the input signal going into the amplifier is negative. Because the amplifier is operating in single supply voltage, a voltage divider using R_3 and R_4 is implemented to bias the amplifier so the inverting input signal is within the input common voltage range of the amplifier. The capacitor C_1 is placed between the inverting input and resistor R_1 to block the DC signal going into the AC signal source, V_{IN} . The values of R_1 and C_1 affect the cutoff frequency, $f_c = \frac{1}{2\pi} R_1 C_1$. As a result, the output signal is centered around mid-supply (if the voltage divider provides $V^*/2$ at the non-inverting input). The output can swing to both rails, maximizing the signal-to-noise ratio in a low voltage system.

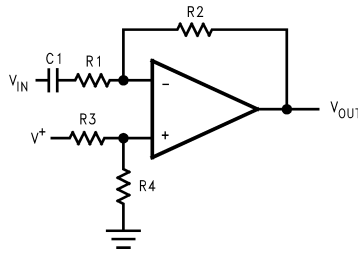

Figure 6. Single-supply Inverting Amplifier

$$V_{OUT} = -\frac{R_2}{R_1} V_{IN} \quad (2)$$

INSTRUMENTATION AMPLIFIER

Measurement of very small signals with an amplifier requires close attention to the input impedance of the amplifier, the overall signal gain from both inputs to the output, as well as, the gain from each input to the output. This is because we are only interested in the difference of the two inputs and the common signal is considered noise. A classic solution is an instrumentation amplifier. Instrumentation amplifiers have a finite, accurate, and stable gain. Also they have extremely high input impedances and very low output impedances. Finally they have an extremely high CMRR so that the amplifier can only respond to the differential signal.

Three-Op-Amp Instrumentation Amplifier

A typical instrumentation amplifier is shown in [Figure 7](#).

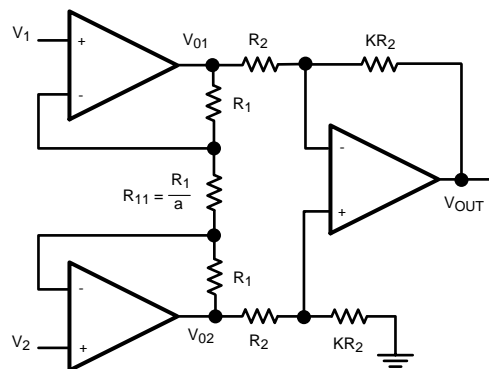

Figure 7. Three-Op-Amp Instrumentation Amplifier

There are two stages in this configuration. The last stage, the output stage, is a differential amplifier. In an ideal case the two amplifiers of the first stage, the input stage, would be set up as buffers to isolate the inputs. However they cannot be connected as followers due to the mismatch of real amplifiers. The circuit in [Figure 7](#) utilizes a balancing resistor between the two amplifiers to compensate for this mismatch. The product of the two stages of gain will be the gain of the instrumentation amplifier circuit. Ideally, the CMRR should be infinite. However the output stage has a small non-zero common mode gain which results from resistor mismatch.

In the input stage of the circuit, current is the same across all resistors. This is due to the high input impedance and low input bias current of the SM73303. With the node equations we have:

$$\text{GIVEN: } I_{R_1} = I_{R_{11}} \quad (3)$$

By Ohm's Law:

$$\begin{aligned}
 V_{O1} - V_{O2} &= (2R_1 + R_{11}) I_{R_{11}} \\
 &= (2a + 1) R_{11} \cdot I_{R_{11}} \\
 &= (2a + 1) V_{R_{11}}
 \end{aligned}
 \tag{4}$$

However:

$$V_{R_{11}} = V_1 - V_2 \tag{5}$$

So we have:

$$V_{O1} - V_{O2} = (2a + 1) (V_1 - V_2) \tag{6}$$

Now looking at the output of the instrumentation amplifier:

$$\begin{aligned}
 V_O &= \frac{KR_2}{R_2} (V_{O2} - V_{O1}) \\
 &= -K (V_{O1} - V_{O2})
 \end{aligned}
 \tag{7}$$

Substituting from Equation 6:

$$V_O = -K (2a + 1) (V_1 - V_2) \tag{8}$$

This shows the gain of the instrumentation amplifier to be:

$$-K(2a+1) \tag{9}$$

Typical values for this circuit can be obtained by setting: $a = 12$ and $K = 4$. This results in an overall gain of -100 .

Three SM73303 amplifiers are used along with 1% resistors to minimize resistor mismatch. Resistors used to build the circuit are: $R_1 = 21.6 \text{ k}\Omega$, $R_{11} = 1.8 \text{ k}\Omega$, $R_2 = 2.5 \text{ k}\Omega$ with $K = 40$ and $a = 12$. This results in an overall gain of $-K(2a+1) = -1000$.

Two-Op-Amp Instrumentation Amplifier

A two-op-amp instrumentation amplifier can also be used to make a high-input impedance DC differential amplifier (Figure 8). As in the three op amp circuit, this instrumentation amplifier requires precise resistor matching for good CMRR. R_4 should be equal to R_1 , and R_3 should equal R_2 .

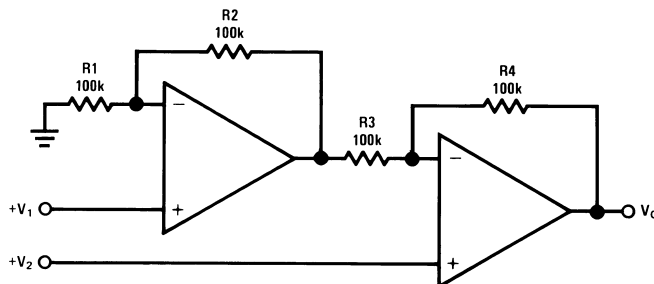

Figure 8. Two-Op-Amp Instrumentation Amplifier

$$\begin{aligned}
 V_O &= \left(1 + \frac{R_4}{R_3}\right) (V_2 - V_1), \text{ where } R_1 = R_4 \text{ and } R_2 = R_3 \\
 \text{As shown: } V_O &= 2(V_2 - V_1)
 \end{aligned}
 \tag{10}$$

ACTIVE FILTERS

Active filters are circuits with amplifiers, resistors, and capacitors. The use of amplifiers instead of inductors, which are used in passive filters, enhances the circuit performance while reducing the size and complexity of the filter. The simplest active filters are designed using an inverting op amp configuration where at least one reactive element has been added to the configuration. This means that the op amp will provide "frequency-dependent" amplification, since reactive elements are frequency dependent devices.

Low Pass Filter

The following shows a very simple low pass filter.

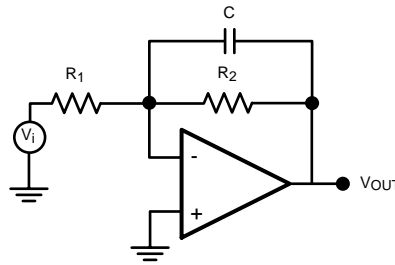

Figure 9. Low Pass Filter

The transfer function can be expressed as follows:

By KCL:

$$\frac{-V_i}{R_1} - \frac{V_O}{\left[\frac{1}{j\omega C} \right]} - \frac{V_O}{R_2} = 0 \quad (11)$$

Simplifying this further results in:

$$V_O = \frac{-R_2}{R_1} \left[\frac{1}{j\omega C R_2 + 1} \right] V_i \quad (12)$$

or

$$\frac{V_O}{V_i} = \frac{-R_2}{R_1} \left[\frac{1}{j\omega C R_2 + 1} \right] \quad (13)$$

Now, substituting $\omega = 2\pi f$, so that the calculations are in f (Hz) rather than in ω (rad/s), and setting the DC gain

$$\left[\frac{-R_2}{R_1} = H_0 \right] \text{ and } H = \frac{V_O}{V_i} \quad (14)$$

$$H = H_0 \left[\frac{1}{j2\pi f C R_2 + 1} \right]$$

$$f_0 = \frac{1}{2\pi R_1 C}$$

set:

$$H = H_0 \left[\frac{1}{1 + j(f/f_0)} \right] \quad (15)$$

Low pass filters are known as lossy integrators because they only behave as integrators at higher frequencies. The general form of the bode plot can be predicted just by looking at the transfer function. When the f/f_0 ratio is small, the capacitor is, in effect, an open circuit and the amplifier behaves at a set DC gain. Starting at f_0 , which is the -3 dB corner, the capacitor will have the dominant impedance and hence the circuit will behave as an integrator and the signal will be attenuated and eventually cut. The bode plot for this filter is shown in [Figure 10](#).

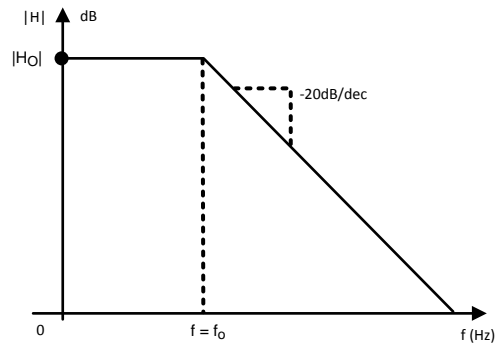

Figure 10. Low Pass Filter Transfer Function

High Pass Filter

The transfer function of a high pass filter can be derived in much the same way as the previous example. A typical first order high pass filter is shown below:

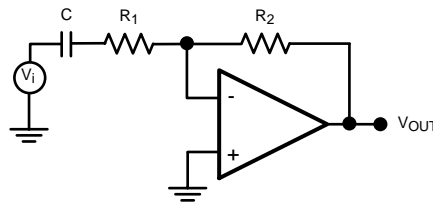

Figure 11. High Pass Filter

Writing the KCL for this circuit :

(V_1 denotes the voltage between C and R_1)

$$\frac{V_1 - V_1}{j\omega C} = \frac{V_1 - V^-}{R_1} \tag{16}$$

$$\frac{V^- + V_1}{R_1} = \frac{V^- + V_O}{R_2} \tag{17}$$

Solving these two equations to find the transfer function and using:

$$f_0 = \frac{1}{2\pi R_1 C} \tag{18}$$

(high frequency gain) $H_0 = \frac{-R_2}{R_1}$ and $H = \frac{V_O}{V_i}$

Which gives:

$$H = H_0 \frac{j(f/f_0)}{1 + j(f/f_0)} \tag{19}$$

Looking at the transfer function, it is clear that when f/f_0 is small, the capacitor is open and therefore, no signal is getting to the amplifier. As the frequency increases the amplifier starts operating. At $f = f_0$ the capacitor behaves like a short circuit and the amplifier will have a constant, high frequency gain of H_0 . Figure 12 shows the transfer function of this high pass filter.

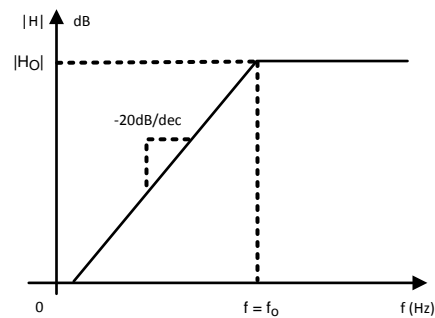

Figure 12. High Pass Filter Transfer Function

Band Pass Filter

Combining a low pass filter and a high pass filter will generate a band pass filter. [Figure 13](#) offers an example of this type of circuit.

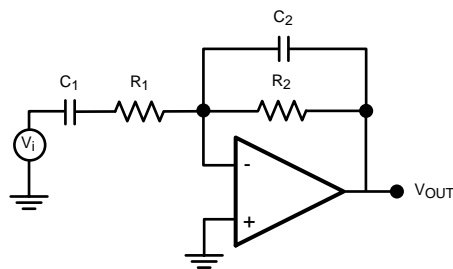

Figure 13. Band Pass Filter

In this network the input impedance forms the high pass filter while the feedback impedance forms the low pass filter. If the designer chooses the corner frequencies so that $f_1 < f_2$, then all the frequencies between, $f_1 \leq f \leq f_2$, will pass through the filter while frequencies below f_1 and above f_2 will be cut off.

The transfer function can be easily calculated using the same methodology as before and is shown in [Figure 14](#).

$$H = H_0 \frac{j(f/f_1)}{[1 + j(f/f_1)] [1 + j(f/f_2)]} \quad (20)$$

Where

$$f_1 = \frac{1}{2\pi R_1 C_1}$$

$$f_2 = \frac{1}{2\pi R_2 C_2}$$

$$H_0 = \frac{-R_2}{R_1} \quad (21)$$

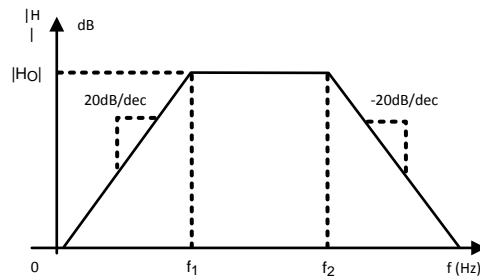

Figure 14. Band Pass Filter Transfer Function

STATE VARIABLE ACTIVE FILTER

State variable active filters are circuits that can simultaneously represent high pass, band pass, and low pass filters. The state variable active filter uses three separate amplifiers to achieve this task. A typical state variable active filter is shown in Figure 15. The first amplifier in the circuit is connected as a gain stage. The second and third amplifiers are connected as integrators, which means they behave as low pass filters. The feedback path from the output of the third amplifier to the first amplifier enables this low frequency signal to be fed back with a finite and fairly low closed loop gain. This is while the high frequency signal on the input is still gained up by the open loop gain of the first amplifier. This makes the first amplifier a high pass filter. The high pass signal is then fed into a low pass filter. The outcome is a band pass signal, meaning the second amplifier is a band pass filter. This signal is then fed into the third amplifiers input and so, the third amplifier behaves as a simple low pass filter.

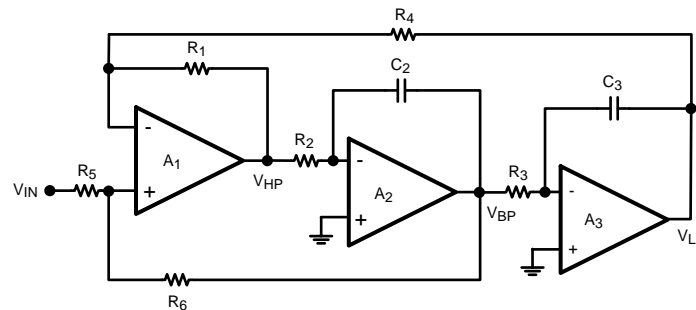
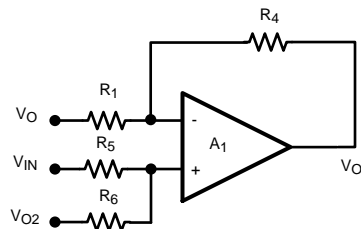
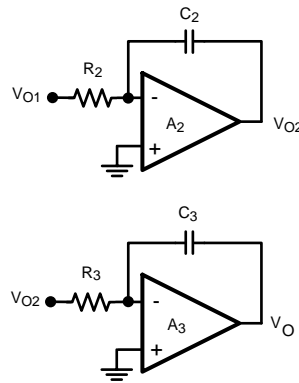

Figure 15. State Variable Active Filter

The transfer function of each filter needs to be calculated. The derivations will be more trivial if each stage of the filter is shown on its own.

The three components are:





For A_1 the relationship between input and output is:

$$V_{O1} = \frac{-R_4}{R_1} V_0 + \left[\frac{R_6}{R_5 + R_6} \right] \left[\frac{R_1 + R_4}{R_1} \right] V_{IN} + \left[\frac{R_5}{R_5 + R_6} \right] \left[\frac{R_1 + R_4}{R_1} \right] V_{O2} \quad (22)$$

This relationship depends on the output of all the filters. The input-output relationship for A_2 can be expressed as:

$$V_{O2} = \frac{-1}{s C_2 R_2} V_{O1} \quad (23)$$

And finally this relationship for A_3 is as follows:

$$V_O = \frac{-1}{s C_3 R_3} V_{O2} \quad (24)$$

Re-arranging these equations, one can find the relationship between V_O and V_{IN} (transfer function of the low pass filter), V_{O1} and V_{IN} (transfer function of the high pass filter), and V_{O2} and V_{IN} (transfer function of the band pass filter) These relationships are as follows:

Low Pass Filter

$$\frac{V_O}{V_{IN}} = \frac{\left[\frac{R_1 + R_4}{R_1} \right] \left[\frac{R_6}{R_5 + R_6} \right] \left[\frac{1}{C_2 C_3 R_2 R_3} \right]}{s^2 + s \left[\frac{1}{C_2 R_2} \right] \left[\frac{R_5}{R_5 + R_6} \right] \left[\frac{R_1 + R_4}{R_1} \right] + \left[\frac{1}{C_2 C_3 R_2 R_3} \right]} \quad (25)$$

(26)

High Pass Filter

$$\frac{V_{O1}}{V_{IN}} = \frac{s^2 \left[\frac{R_1 + R_4}{R_1} \right] \left[\frac{R_6}{R_5 + R_6} \right]}{s^2 + s \left[\frac{1}{C_2 R_2} \right] \left[\frac{R_5}{R_5 + R_6} \right] \left[\frac{R_1 + R_4}{R_1} \right] + \left[\frac{1}{C_2 C_3 R_2 R_3} \right]} \quad (27)$$

Band Pass Filter

$$\frac{V_{O2}}{V_{IN}} = \frac{s \left[\frac{1}{C_2 R_2} \right] \left[\frac{R_1 + R_4}{R_1} \right] \left[\frac{R_6}{R_5 + R_6} \right]}{s^2 + s \left[\frac{1}{C_2 R_2} \right] \left[\frac{R_5}{R_5 + R_6} \right] \left[\frac{R_1 + R_4}{R_1} \right] + \left[\frac{1}{C_2 C_3 R_2 R_3} \right]} \quad (28)$$

The center frequency and Quality Factor for all of these filters is the same. The values can be calculated in the following manner:

$$\omega_c = \sqrt{\frac{1}{C_2 C_3 R_2 R_3}}$$

and

$$Q = \sqrt{\frac{C_2 R_2}{C_3 R_3} \left[\frac{R_5 + R_6}{R_6} \right] \left[\frac{R_1}{R_1 + R_4} \right]} \quad (29)$$

Designing a band pass filter with a center frequency of 10 kHz and Quality Factor of 5.5

To do this, first consider the Quality Factor. It is best to pick convenient values for the capacitors. $C_2 = C_3 = 1000$ pF. Also, choose $R_1 = R_4 = 30$ k Ω . Now values of R_5 and R_6 need to be calculated. With the chosen values for the capacitors and resistors, Q reduces to:

$$Q = \frac{11}{2} = \frac{1}{2} \left[\frac{R_5 + R_6}{R_6} \right] \quad (30)$$

or

$$R_5 = 10R_6 \quad R_6 = 1.5 \text{ k}\Omega \quad R_5 = 15 \text{ k}\Omega \quad (31)$$

Also, for $f = 10$ kHz, the center frequency is $\omega_c = 2\pi f = 62.8$ kHz.

Using the expressions above, the appropriate resistor values will be $R_2 = R_3 = 16$ k Ω .

The DC gain of this circuit is:

$$\text{DC GAIN} = \left[\frac{R_1 + R_4}{R_1} \right] \left[\frac{R_6}{R_5 + R_6} \right] = -14.8 \text{ dB} \quad (32)$$

IMPORTANT NOTICE

Texas Instruments Incorporated and its subsidiaries (TI) reserve the right to make corrections, enhancements, improvements and other changes to its semiconductor products and services per JESD46, latest issue, and to discontinue any product or service per JESD48, latest issue. Buyers should obtain the latest relevant information before placing orders and should verify that such information is current and complete. All semiconductor products (also referred to herein as "components") are sold subject to TI's terms and conditions of sale supplied at the time of order acknowledgment.

TI warrants performance of its components to the specifications applicable at the time of sale, in accordance with the warranty in TI's terms and conditions of sale of semiconductor products. Testing and other quality control techniques are used to the extent TI deems necessary to support this warranty. Except where mandated by applicable law, testing of all parameters of each component is not necessarily performed.

TI assumes no liability for applications assistance or the design of Buyers' products. Buyers are responsible for their products and applications using TI components. To minimize the risks associated with Buyers' products and applications, Buyers should provide adequate design and operating safeguards.

TI does not warrant or represent that any license, either express or implied, is granted under any patent right, copyright, mask work right, or other intellectual property right relating to any combination, machine, or process in which TI components or services are used. Information published by TI regarding third-party products or services does not constitute a license to use such products or services or a warranty or endorsement thereof. Use of such information may require a license from a third party under the patents or other intellectual property of the third party, or a license from TI under the patents or other intellectual property of TI.

Reproduction of significant portions of TI information in TI data books or data sheets is permissible only if reproduction is without alteration and is accompanied by all associated warranties, conditions, limitations, and notices. TI is not responsible or liable for such altered documentation. Information of third parties may be subject to additional restrictions.

Resale of TI components or services with statements different from or beyond the parameters stated by TI for that component or service voids all express and any implied warranties for the associated TI component or service and is an unfair and deceptive business practice. TI is not responsible or liable for any such statements.

Buyer acknowledges and agrees that it is solely responsible for compliance with all legal, regulatory and safety-related requirements concerning its products, and any use of TI components in its applications, notwithstanding any applications-related information or support that may be provided by TI. Buyer represents and agrees that it has all the necessary expertise to create and implement safeguards which anticipate dangerous consequences of failures, monitor failures and their consequences, lessen the likelihood of failures that might cause harm and take appropriate remedial actions. Buyer will fully indemnify TI and its representatives against any damages arising out of the use of any TI components in safety-critical applications.

In some cases, TI components may be promoted specifically to facilitate safety-related applications. With such components, TI's goal is to help enable customers to design and create their own end-product solutions that meet applicable functional safety standards and requirements. Nonetheless, such components are subject to these terms.

No TI components are authorized for use in FDA Class III (or similar life-critical medical equipment) unless authorized officers of the parties have executed a special agreement specifically governing such use.

Only those TI components which TI has specifically designated as military grade or "enhanced plastic" are designed and intended for use in military/aerospace applications or environments. Buyer acknowledges and agrees that any military or aerospace use of TI components which have **not** been so designated is solely at the Buyer's risk, and that Buyer is solely responsible for compliance with all legal and regulatory requirements in connection with such use.

TI has specifically designated certain components as meeting ISO/TS16949 requirements, mainly for automotive use. In any case of use of non-designated products, TI will not be responsible for any failure to meet ISO/TS16949.

Products

Audio	www.ti.com/audio
Amplifiers	amplifier.ti.com
Data Converters	dataconverter.ti.com
DLP® Products	www.dlp.com
DSP	dsp.ti.com
Clocks and Timers	www.ti.com/clocks
Interface	interface.ti.com
Logic	logic.ti.com
Power Mgmt	power.ti.com
Microcontrollers	microcontroller.ti.com
RFID	www.ti-rfid.com
OMAP Applications Processors	www.ti.com/omap
Wireless Connectivity	www.ti.com/wirelessconnectivity

Applications

Automotive and Transportation	www.ti.com/automotive
Communications and Telecom	www.ti.com/communications
Computers and Peripherals	www.ti.com/computers
Consumer Electronics	www.ti.com/consumer-apps
Energy and Lighting	www.ti.com/energy
Industrial	www.ti.com/industrial
Medical	www.ti.com/medical
Security	www.ti.com/security
Space, Avionics and Defense	www.ti.com/space-avionics-defense
Video and Imaging	www.ti.com/video

TI E2E Community

e2e.ti.com