

# SN54AHC240, SN74AHC240 OCTAL BUFFERS/DRIVERS WITH 3-STATE OUTPUTS

SCLS251H – OCTOBER 1995 – REVISED JULY 2003

- Operating Range 2-V to 5.5-V  $V_{CC}$
- Latch-Up Performance Exceeds 250 mA Per JESD 17

## description/ordering information

These octal buffers/drivers are designed specifically to improve the performance and density of 3-state memory-address drivers, clock drivers, and bus-oriented receivers and transmitters.

The 'AHC240 devices are organized as two 4-bit buffers/line drivers with separate output-enable ( $\overline{OE}$ ) inputs. When  $\overline{OE}$  is low, the device passes data from the A inputs to the Y outputs. When  $\overline{OE}$  is high, the outputs are in the high-impedance state.

To ensure the high-impedance state during power up or power down,  $\overline{OE}$  should be tied to  $V_{CC}$  through a pullup resistor; the minimum value of the resistor is determined by the current-sinking capability of the driver.

SN54AHC240 . . . J OR W PACKAGE  
SN74AHC240 . . . DB, DGV, DW, N, NS, OR PW PACKAGE  
(TOP VIEW)

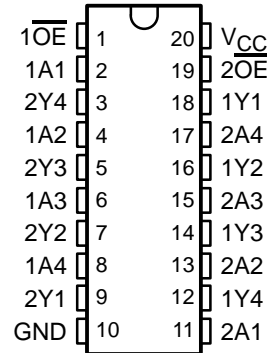

SN54AHC240 . . . FK PACKAGE  
(TOP VIEW)

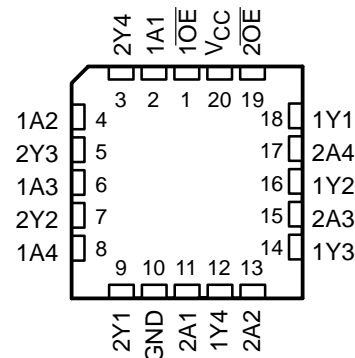

## ORDERING INFORMATION

$T_A$	PACKAGE†		ORDERABLE PART NUMBER	TOP-SIDE MARKING
-40°C to 85°C	PDIP – N	Tube	SN74AHC240N	SN74AHC240N
	SOIC – DW	Tube	SN74AHC240DW	AHC240
		Tape and reel	SN74AHC240DWR	
	SOP – NS	Tape and reel	SN74AHC240NSR	AHC240
	SSOP – DB	Tape and reel	SN74AHC240DBR	HA240
	TSSOP – PW	Tube	SN74AHC240PW	HA240
		Tape and reel	SN74AHC240PWR	
TVSOP – DGV	Tape and reel	SN74AHC240DGV	HA240	
-55°C to 125°C	CDIP – J	Tube	SNJ54AHC240J	SNJ54AHC240J
	CFP – W	Tube	SNJ54AHC240W	SNJ54AHC240W
	LCCC – FK	Tube	SNJ54AHC240FK	SNJ54AHC240FK

† Package drawings, standard packing quantities, thermal data, symbolization, and PCB design guidelines are available at [www.ti.com/sc/package](http://www.ti.com/sc/package).



Please be aware that an important notice concerning availability, standard warranty, and use in critical applications of Texas Instruments semiconductor products and disclaimers thereto appears at the end of this data sheet.

PRODUCTION DATA information is current as of publication date. Products conform to specifications per the terms of Texas Instruments standard warranty. Production processing does not necessarily include testing of all parameters.

 **TEXAS  
INSTRUMENTS**

POST OFFICE BOX 655303 • DALLAS, TEXAS 75265

Copyright © 2003, Texas Instruments Incorporated  
On products compliant to MIL-PRF-38535, all parameters are tested unless otherwise noted. On all other products, production processing does not necessarily include testing of all parameters.

# SN54AHC240, SN74AHC240 OCTAL BUFFERS/DRIVERS WITH 3-STATE OUTPUTS

SCLS251H – OCTOBER 1995 – REVISED JULY 2003

**FUNCTION TABLE**  
(each 4-bit buffer/driver)

INPUTS		OUTPUT
$\overline{OE}$	A	Y
L	H	L
L	L	H
H	X	Z

## logic diagram (positive logic)

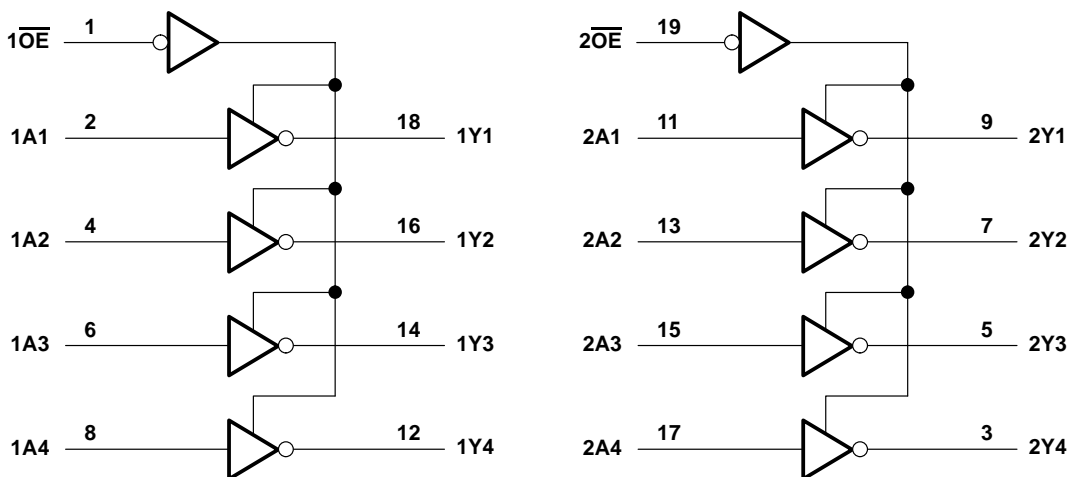

## absolute maximum ratings over operating free-air temperature range (unless otherwise noted)†

Supply voltage range, $V_{CC}$	-0.5 V to 7 V
Input voltage range, $V_I$ (see Note 1)	-0.5 V to 7 V
Output voltage range, $V_O$ (see Note 1)	-0.5 V to $V_{CC} + 0.5$ V
Input clamp current, $I_{IK}$ ( $V_I < 0$ )	-20 mA
Output clamp current, $I_{OK}$ ( $V_O < 0$ or $V_O > V_{CC}$ )	$\pm 20$ mA
Continuous output current, $I_O$ ( $V_O = 0$ to $V_{CC}$ )	$\pm 25$ mA
Continuous current through $V_{CC}$ or GND	$\pm 75$ mA
Package thermal impedance, $\theta_{JA}$ (see Note 2):	
DB package	70°C/W
DGV package	92°C/W
DW package	58°C/W
N package	69°C/W
NS package	60°C/W
PW package	83°C/W
Storage temperature range, $T_{stg}$	-65°C to 150°C

† Stresses beyond those listed under “absolute maximum ratings” may cause permanent damage to the device. These are stress ratings only, and functional operation of the device at these or any other conditions beyond those indicated under “recommended operating conditions” is not implied. Exposure to absolute-maximum-rated conditions for extended periods may affect device reliability.

- NOTES: 1. The input and output voltage ratings may be exceeded if the input and output current ratings are observed.  
2. The package thermal impedance is calculated in accordance with JESD 51-7.

# SN54AHC240, SN74AHC240 OCTAL BUFFERS/DRIVERS WITH 3-STATE OUTPUTS

SCLS251H – OCTOBER 1995 – REVISED JULY 2003

## recommended operating conditions (see Note 3)

		SN54AHC240		SN74AHC240		UNIT
		MIN	MAX	MIN	MAX	
V <sub>CC</sub>	Supply voltage	2	5.5	2	5.5	V
V <sub>IH</sub>	High-level input voltage	V <sub>CC</sub> = 2 V		1.5		V
		V <sub>CC</sub> = 3 V		2.1		
		V <sub>CC</sub> = 5.5 V		3.85		
V <sub>IL</sub>	Low-level input voltage	V <sub>CC</sub> = 2 V		0.5		V
		V <sub>CC</sub> = 3 V		0.9		
		V <sub>CC</sub> = 5.5 V		1.65		
V <sub>I</sub>	Input voltage	0	5.5	0	5.5	V
V <sub>O</sub>	Output voltage	0	V <sub>CC</sub>	0	V <sub>CC</sub>	V
I <sub>OH</sub>	High-level output current	V <sub>CC</sub> = 2 V		-50		μA
		V <sub>CC</sub> = 3.3 V ± 0.3 V		-4		
		V <sub>CC</sub> = 5 V ± 0.5 V		-8		
I <sub>OL</sub>	Low-level output current	V <sub>CC</sub> = 2 V		50		μA
		V <sub>CC</sub> = 3.3 V ± 0.3 V		4		
		V <sub>CC</sub> = 5 V ± 0.5 V		8		
Δt/Δv	Input transition rise or fall rate	V <sub>CC</sub> = 3.3 V ± 0.3 V		100		ns/V
		V <sub>CC</sub> = 5 V ± 0.5 V		20		
T <sub>A</sub>	Operating free-air temperature	-55	125	-40	85	°C

NOTE 3: All unused inputs of the device must be held at V<sub>CC</sub> or GND to ensure proper device operation. Refer to the TI application report, *Implications of Slow or Floating CMOS Inputs*, literature number SCBA004.

## electrical characteristics over recommended operating free-air temperature range (unless otherwise noted)

PARAMETER	TEST CONDITIONS	V <sub>CC</sub>	T <sub>A</sub> = 25°C			SN54AHC240		SN74AHC240		UNIT
			MIN	TYP	MAX	MIN	MAX	MIN	MAX	
V <sub>OH</sub>	I <sub>OH</sub> = -50 μA	2 V	1.9	2		1.9		1.9	V	
		3 V	2.9	3		2.9		2.9		
		4.5 V	4.4	4.5		4.4		4.4		
	I <sub>OH</sub> = -4 mA	3 V	2.58			2.48		2.48		
	I <sub>OH</sub> = -8 mA	4.5 V	3.94			3.8		3.8		
V <sub>OL</sub>	I <sub>OL</sub> = 50 μA	2 V			0.1		0.1	0.1	V	
		3 V			0.1		0.1	0.1		
		4.5 V			0.1		0.1	0.1		
	I <sub>OL</sub> = 4 mA	3 V			0.36		0.5	0.44		
	I <sub>OL</sub> = 8 mA	4.5 V			0.36		0.5	0.44		
I <sub>I</sub>	V <sub>I</sub> = 5.5 V or GND	0 V to 5.5 V			±0.1		±1*	±1	μA	
I <sub>OZ</sub> †	V <sub>O</sub> = V <sub>CC</sub> or GND, V <sub>I</sub> (OE) = V <sub>IL</sub> or V <sub>IH</sub>	5.5 V			±0.25		±2.5	±2.5	μA	
I <sub>CC</sub>	V <sub>I</sub> = V <sub>CC</sub> or GND, I <sub>O</sub> = 0	5.5 V			4		40	40	μA	
C <sub>i</sub>	V <sub>I</sub> = V <sub>CC</sub> or GND	5 V		2.5	10			10	pF	
C <sub>o</sub>	V <sub>O</sub> = V <sub>CC</sub> or GND	5 V		3.5					pF	

\* On products compliant to MIL-PRF-38535, this parameter is not production tested at V<sub>CC</sub> = 0 V.

† The parameter I<sub>OZ</sub> includes the input leakage current.



**SN54AHC240, SN74AHC240  
OCTAL BUFFERS/DRIVERS  
WITH 3-STATE OUTPUTS**

SCLS251H – OCTOBER 1995 – REVISED JULY 2003

**switching characteristics over recommended operating free-air temperature range,  
V<sub>CC</sub> = 3.3 V ± 0.3 V (unless otherwise noted) (see Figure 1)**

PARAMETER	FROM (INPUT)	TO (OUTPUT)	LOAD CAPACITANCE	T <sub>A</sub> = 25°C			SN54AHC240		SN74AHC240		UNIT
				MIN	TYP	MAX	MIN	MAX	MIN	MAX	
t <sub>PLH</sub>	A	Y	C <sub>L</sub> = 15 pF	5.3*	7.5*	1*	9*	1	9	ns	
t <sub>PHL</sub>				5.3*	7.5*	1*	9*	1	9		
t <sub>PZH</sub>	$\overline{OE}$	Y	C <sub>L</sub> = 15 pF	6.6*	10.6*	1*	12.5*	1	12.5	ns	
t <sub>PZL</sub>				6.6*	10.6*	1*	12.5*	1	12.5		
t <sub>PHZ</sub>	$\overline{OE}$	Y	C <sub>L</sub> = 15 pF	7.8*	11.5*	1*	12.5*	1	12.5	ns	
t <sub>PLZ</sub>				7.8*	11.5*	1*	12.5*	1	12.5		
t <sub>PLH</sub>	A	Y	C <sub>L</sub> = 50 pF	7.8	11	1	12.5	1	12.5	ns	
t <sub>PHL</sub>				7.8	11	1	12.5	1	12.5		
t <sub>PZH</sub>	$\overline{OE}$	Y	C <sub>L</sub> = 50 pF	9.1	14.1	1	16	1	16	ns	
t <sub>PZL</sub>				9.1	14.1	1	16	1	16		
t <sub>PHZ</sub>	$\overline{OE}$	Y	C <sub>L</sub> = 50 pF	10.3	14	1	16	1	16	ns	
t <sub>PLZ</sub>				10.3	14	1	16	1	16		
t <sub>sk(o)</sub>			C <sub>L</sub> = 50 pF		1.5**				1.5	ns	

\* On products compliant to MIL-PRF-38535, this parameter is not production tested.

\*\* On products compliant to MIL-PRF-38535, this parameter does not apply.

**switching characteristics over recommended operating free-air temperature range,  
V<sub>CC</sub> = 5 V ± 0.5 V (unless otherwise noted) (see Figure 1)**

PARAMETER	FROM (INPUT)	TO (OUTPUT)	LOAD CAPACITANCE	T <sub>A</sub> = 25°C			SN54AHC240		SN74AHC240		UNIT
				MIN	TYP	MAX	MIN	MAX	MIN	MAX	
t <sub>PLH</sub>	A	Y	C <sub>L</sub> = 15 pF	3.6*	5.5*	1*	6.5*	1	6.5	ns	
t <sub>PHL</sub>				3.6*	5.5*	1*	6.5*	1	6.5		
t <sub>PZH</sub>	$\overline{OE}$	Y	C <sub>L</sub> = 15 pF	4.7*	7.3*	1*	8.5*	1	8.5	ns	
t <sub>PZL</sub>				4.7*	7.3*	1*	8.5*	1	8.5		
t <sub>PHZ</sub>	$\overline{OE}$	Y	C <sub>L</sub> = 15 pF	5.2*	7.2*	1*	8.5*	1	8.5	ns	
t <sub>PLZ</sub>				5.2*	7.2*	1*	8.5*	1	8.5		
t <sub>PLH</sub>	A	Y	C <sub>L</sub> = 50 pF	5.1	7.5	1	8.5	1	8.5	ns	
t <sub>PHL</sub>				5.1	7.5	1	8.5	1	8.5		
t <sub>PZH</sub>	$\overline{OE}$	Y	C <sub>L</sub> = 50 pF	6.2	9.3	1	10.5	1	10.5	ns	
t <sub>PZL</sub>				6.2	9.3	1	10.5	1	10.5		
t <sub>PHZ</sub>	$\overline{OE}$	Y	C <sub>L</sub> = 50 pF	6.7	9.2	1	10.5	1	10.5	ns	
t <sub>PLZ</sub>				6.7	9.2	1	10.5	1	10.5		
t <sub>sk(o)</sub>			C <sub>L</sub> = 50 pF		1**				1	ns	

\* On products compliant to MIL-PRF-38535, this parameter is not production tested.

\*\* On products compliant to MIL-PRF-38535, this parameter does not apply.



**SN54AHC240, SN74AHC240  
OCTAL BUFFERS/DRIVERS  
WITH 3-STATE OUTPUTS**

SCLS251H – OCTOBER 1995 – REVISED JULY 2003

**noise characteristics,  $V_{CC} = 5\text{ V}$ ,  $C_L = 50\text{ pF}$ ,  $T_A = 25^\circ\text{C}$  (see Note 4)**

PARAMETER	SN74AHC240			UNIT
	MIN	TYP	MAX	
$V_{OL(P)}$ Quiet output, maximum dynamic $V_{OL}$		0.6		V
$V_{OL(V)}$ Quiet output, minimum dynamic $V_{OL}$		-0.6		V
$V_{OH(V)}$ Quiet output, minimum dynamic $V_{OH}$		4.6		V
$V_{IH(D)}$ High-level dynamic input voltage	3.5			V
$V_{IL(D)}$ Low-level dynamic input voltage			1.5	V

NOTE 4: Characteristics are for surface-mount packages only.

**operating characteristics,  $V_{CC} = 5\text{ V}$ ,  $T_A = 25^\circ\text{C}$**

PARAMETER	TEST CONDITIONS	TYP	UNIT
$C_{pd}$ Power dissipation capacitance	No load, $f = 1\text{ MHz}$	10	pF

# SN54AHC240, SN74AHC240 OCTAL BUFFERS/DRIVERS WITH 3-STATE OUTPUTS

SCLS251H – OCTOBER 1995 – REVISED JULY 2003

## PARAMETER MEASUREMENT INFORMATION

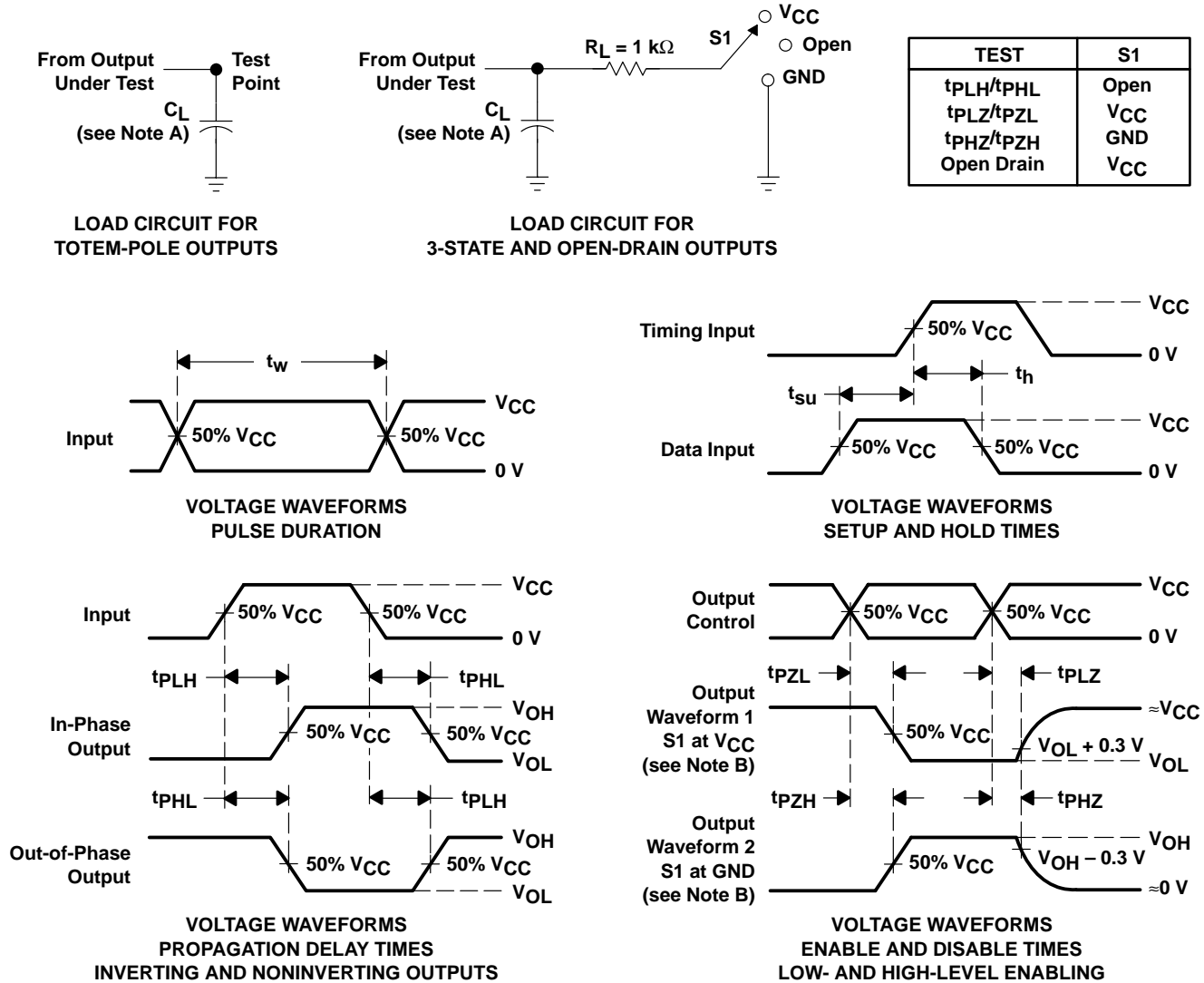

- NOTES:
- A.  $C_L$  includes probe and jig capacitance.
  - B. Waveform 1 is for an output with internal conditions such that the output is low except when disabled by the output control. Waveform 2 is for an output with internal conditions such that the output is high except when disabled by the output control.
  - C. All input pulses are supplied by generators having the following characteristics:  $PRR \leq 1\text{ MHz}$ ,  $Z_O = 50\ \Omega$ ,  $t_r \leq 3\text{ ns}$ ,  $t_f \leq 3\text{ ns}$ .
  - D. The outputs are measured one at a time with one input transition per measurement.
  - E. All parameters and waveforms are not applicable to all devices.

Figure 1. Load Circuit and Voltage Waveforms

**PACKAGING INFORMATION**

Orderable Device	Status (1)	Package Type	Package Drawing	Pins	Package Qty	Eco Plan (2)	Lead/Ball Finish	MSL Peak Temp (3)	Op Temp (°C)	Top-Side Markings (4)	Samples
5962-9680701Q2A	ACTIVE	LCCC	FK	20	1	TBD	Call TI	Call TI	-55 to 125	5962-9680701Q2A SNJ54AHC 240FK	<a href="#">Samples</a>
5962-9680701QRA	ACTIVE	CDIP	J	20	1	TBD	Call TI	Call TI	-55 to 125	5962-9680701QR A SNJ54AHC240J	<a href="#">Samples</a>
5962-9680701QSA	ACTIVE	CFP	W	20	1	TBD	Call TI	Call TI	-55 to 125	5962-9680701QS A SNJ54AHC240W	<a href="#">Samples</a>
SN74AHC240DBLE	OBSOLETE	SSOP	DB	20		TBD	Call TI	Call TI	-40 to 85		
SN74AHC240DGVR	ACTIVE	TVSOP	DGV	20	2000	Green (RoHS & no Sb/Br)	CU NIPDAU	Level-1-260C-UNLIM	-40 to 85	HA240	<a href="#">Samples</a>
SN74AHC240DGVRE4	ACTIVE	TVSOP	DGV	20	2000	Green (RoHS & no Sb/Br)	CU NIPDAU	Level-1-260C-UNLIM	-40 to 85	HA240	<a href="#">Samples</a>
SN74AHC240DGVRG4	ACTIVE	TVSOP	DGV	20	2000	Green (RoHS & no Sb/Br)	CU NIPDAU	Level-1-260C-UNLIM	-40 to 85	HA240	<a href="#">Samples</a>
SN74AHC240DW	ACTIVE	SOIC	DW	20	25	Green (RoHS & no Sb/Br)	CU NIPDAU	Level-1-260C-UNLIM	-40 to 85	AHC240	<a href="#">Samples</a>
SN74AHC240DWE4	ACTIVE	SOIC	DW	20	25	Green (RoHS & no Sb/Br)	CU NIPDAU	Level-1-260C-UNLIM	-40 to 85	AHC240	<a href="#">Samples</a>
SN74AHC240DWG4	ACTIVE	SOIC	DW	20	25	Green (RoHS & no Sb/Br)	CU NIPDAU	Level-1-260C-UNLIM	-40 to 85	AHC240	<a href="#">Samples</a>
SN74AHC240DWR	ACTIVE	SOIC	DW	20	2000	Green (RoHS & no Sb/Br)	CU NIPDAU	Level-1-260C-UNLIM	-40 to 85	AHC240	<a href="#">Samples</a>
SN74AHC240DWRE4	ACTIVE	SOIC	DW	20	2000	Green (RoHS & no Sb/Br)	CU NIPDAU	Level-1-260C-UNLIM	-40 to 85	AHC240	<a href="#">Samples</a>
SN74AHC240DWRG4	ACTIVE	SOIC	DW	20	2000	Green (RoHS & no Sb/Br)	CU NIPDAU	Level-1-260C-UNLIM	-40 to 85	AHC240	<a href="#">Samples</a>
SN74AHC240N	ACTIVE	PDIP	N	20	20	Pb-Free (RoHS)	CU NIPDAU	N / A for Pkg Type	-40 to 85	SN74AHC240N	<a href="#">Samples</a>
SN74AHC240NE4	ACTIVE	PDIP	N	20	20	Pb-Free (RoHS)	CU NIPDAU	N / A for Pkg Type	-40 to 85	SN74AHC240N	<a href="#">Samples</a>
SN74AHC240NSR	ACTIVE	SO	NS	20	2000	Green (RoHS & no Sb/Br)	CU NIPDAU	Level-1-260C-UNLIM	-40 to 85	AHC240	<a href="#">Samples</a>

Orderable Device	Status (1)	Package Type	Package Drawing	Pins	Package Qty	Eco Plan (2)	Lead/Ball Finish	MSL Peak Temp (3)	Op Temp (°C)	Top-Side Markings (4)	Samples
SN74AHC240NSRE4	ACTIVE	SO	NS	20	2000	Green (RoHS & no Sb/Br)	CU NIPDAU	Level-1-260C-UNLIM	-40 to 85	AHC240	<a href="#">Samples</a>
SN74AHC240NSRG4	ACTIVE	SO	NS	20	2000	Green (RoHS & no Sb/Br)	CU NIPDAU	Level-1-260C-UNLIM	-40 to 85	AHC240	<a href="#">Samples</a>
SN74AHC240PW	ACTIVE	TSSOP	PW	20	70	Green (RoHS & no Sb/Br)	CU NIPDAU	Level-1-260C-UNLIM	-40 to 85	HA240	<a href="#">Samples</a>
SN74AHC240PWE4	ACTIVE	TSSOP	PW	20	70	Green (RoHS & no Sb/Br)	CU NIPDAU	Level-1-260C-UNLIM	-40 to 85	HA240	<a href="#">Samples</a>
SN74AHC240PWG4	ACTIVE	TSSOP	PW	20	70	Green (RoHS & no Sb/Br)	CU NIPDAU	Level-1-260C-UNLIM	-40 to 85	HA240	<a href="#">Samples</a>
SN74AHC240PWLE	OBSOLETE	TSSOP	PW	20		TBD	Call TI	Call TI	-40 to 85		
SN74AHC240PWR	ACTIVE	TSSOP	PW	20	2000	Green (RoHS & no Sb/Br)	CU NIPDAU	Level-1-260C-UNLIM	-40 to 85	HA240	<a href="#">Samples</a>
SN74AHC240PWRE4	ACTIVE	TSSOP	PW	20	2000	Green (RoHS & no Sb/Br)	CU NIPDAU	Level-1-260C-UNLIM	-40 to 85	HA240	<a href="#">Samples</a>
SN74AHC240PWRG4	ACTIVE	TSSOP	PW	20	2000	Green (RoHS & no Sb/Br)	CU NIPDAU	Level-1-260C-UNLIM	-40 to 85	HA240	<a href="#">Samples</a>
SNJ54AHC240FK	ACTIVE	LCCC	FK	20	1	TBD	POST-PLATE	N / A for Pkg Type	-55 to 125	5962-9680701Q2A SNJ54AHC 240FK	<a href="#">Samples</a>
SNJ54AHC240J	ACTIVE	CDIP	J	20	1	TBD	A42	N / A for Pkg Type	-55 to 125	5962-9680701QR A SNJ54AHC240J	<a href="#">Samples</a>
SNJ54AHC240W	ACTIVE	CFP	W	20	1	TBD	Call TI	N / A for Pkg Type	-55 to 125	5962-9680701QS A SNJ54AHC240W	<a href="#">Samples</a>

(1) The marketing status values are defined as follows:

**ACTIVE:** Product device recommended for new designs.

**LIFEBUY:** TI has announced that the device will be discontinued, and a lifetime-buy period is in effect.

**NRND:** Not recommended for new designs. Device is in production to support existing customers, but TI does not recommend using this part in a new design.

**PREVIEW:** Device has been announced but is not in production. Samples may or may not be available.

**OBSOLETE:** TI has discontinued the production of the device.

(2) Eco Plan - The planned eco-friendly classification: Pb-Free (RoHS), Pb-Free (RoHS Exempt), or Green (RoHS & no Sb/Br) - please check <http://www.ti.com/productcontent> for the latest availability information and additional product content details.

**TBD:** The Pb-Free/Green conversion plan has not been defined.



---

**Pb-Free (RoHS):** TI's terms "Lead-Free" or "Pb-Free" mean semiconductor products that are compatible with the current RoHS requirements for all 6 substances, including the requirement that lead not exceed 0.1% by weight in homogeneous materials. Where designed to be soldered at high temperatures, TI Pb-Free products are suitable for use in specified lead-free processes.

**Pb-Free (RoHS Exempt):** This component has a RoHS exemption for either 1) lead-based flip-chip solder bumps used between the die and package, or 2) lead-based die adhesive used between the die and leadframe. The component is otherwise considered Pb-Free (RoHS compatible) as defined above.

**Green (RoHS & no Sb/Br):** TI defines "Green" to mean Pb-Free (RoHS compatible), and free of Bromine (Br) and Antimony (Sb) based flame retardants (Br or Sb do not exceed 0.1% by weight in homogeneous material)

<sup>(3)</sup> MSL, Peak Temp. -- The Moisture Sensitivity Level rating according to the JEDEC industry standard classifications, and peak solder temperature.

<sup>(4)</sup> Only one of markings shown within the brackets will appear on the physical device.

**Important Information and Disclaimer:** The information provided on this page represents TI's knowledge and belief as of the date that it is provided. TI bases its knowledge and belief on information provided by third parties, and makes no representation or warranty as to the accuracy of such information. Efforts are underway to better integrate information from third parties. TI has taken and continues to take reasonable steps to provide representative and accurate information but may not have conducted destructive testing or chemical analysis on incoming materials and chemicals. TI and TI suppliers consider certain information to be proprietary, and thus CAS numbers and other limited information may not be available for release.

In no event shall TI's liability arising out of such information exceed the total purchase price of the TI part(s) at issue in this document sold by TI to Customer on an annual basis.

**OTHER QUALIFIED VERSIONS OF SN54AHC240, SN74AHC240 :**

● Catalog: [SN74AHC240](#)

● Military: [SN54AHC240](#)

NOTE: Qualified Version Definitions:

- Catalog - TI's standard catalog product
- Military - QML certified for Military and Defense Applications

**TAPE AND REEL INFORMATION**

**QUADRANT ASSIGNMENTS FOR PIN 1 ORIENTATION IN TAPE**

\*All dimensions are nominal

Device	Package Type	Package Drawing	Pins	SPQ	Reel Diameter (mm)	Reel Width W1 (mm)	A0 (mm)	B0 (mm)	K0 (mm)	P1 (mm)	W (mm)	Pin1 Quadrant
SN74AHC240DGVR	TVSOP	DGV	20	2000	330.0	12.4	6.9	5.6	1.6	8.0	12.0	Q1
SN74AHC240DWR	SOIC	DW	20	2000	330.0	24.4	10.8	13.0	2.7	12.0	24.0	Q1
SN74AHC240NSR	SO	NS	20	2000	330.0	24.4	8.2	13.0	2.5	12.0	24.0	Q1
SN74AHC240PWR	TSSOP	PW	20	2000	330.0	16.4	6.95	7.1	1.6	8.0	16.0	Q1

**TAPE AND REEL BOX DIMENSIONS**

\*All dimensions are nominal

Device	Package Type	Package Drawing	Pins	SPQ	Length (mm)	Width (mm)	Height (mm)
SN74AHC240DGVR	TVSOP	DGV	20	2000	367.0	367.0	35.0
SN74AHC240DWR	SOIC	DW	20	2000	367.0	367.0	45.0
SN74AHC240NSR	SO	NS	20	2000	367.0	367.0	45.0
SN74AHC240PWR	TSSOP	PW	20	2000	367.0	367.0	38.0

J (R-GDIP-T\*\*)

14 LEADS SHOWN

CERAMIC DUAL IN-LINE PACKAGE



DIM \ PINS **	14	16	18	20
A	0.300 (7,62) BSC	0.300 (7,62) BSC	0.300 (7,62) BSC	0.300 (7,62) BSC
B MAX	0.785 (19,94)	.840 (21,34)	0.960 (24,38)	1.060 (26,92)
B MIN	—	—	—	—
C MAX	0.300 (7,62)	0.300 (7,62)	0.310 (7,87)	0.300 (7,62)
C MIN	0.245 (6,22)	0.245 (6,22)	0.220 (5,59)	0.245 (6,22)



4040083/F 03/03

- NOTES:
- All linear dimensions are in inches (millimeters).
  - This drawing is subject to change without notice.
  - This package is hermetically sealed with a ceramic lid using glass frit.
  - Index point is provided on cap for terminal identification only on press ceramic glass frit seal only.
  - Falls within MIL STD 1835 GDIP1-T14, GDIP1-T16, GDIP1-T18 and GDIP1-T20.

W (R-GDFP-F20)

CERAMIC DUAL FLATPACK



- NOTES:
- A. All linear dimensions are in inches (millimeters).
  - B. This drawing is subject to change without notice.
  - C. This package can be hermetically sealed with a ceramic lid using glass frit.
  - D. Index point is provided on cap for terminal identification only.
  - E. Falls within Mil-Std 1835 GDFP2-F20

FK (S-CQCC-N\*\*)

LEADLESS CERAMIC CHIP CARRIER

28 TERMINAL SHOWN

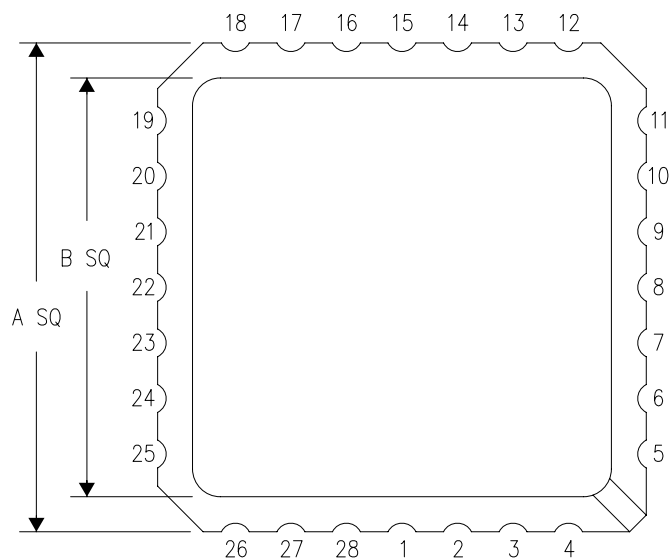

NO. OF TERMINALS **	A		B	
	MIN	MAX	MIN	MAX
20	0.342 (8,69)	0.358 (9,09)	0.307 (7,80)	0.358 (9,09)
28	0.442 (11,23)	0.458 (11,63)	0.406 (10,31)	0.458 (11,63)
44	0.640 (16,26)	0.660 (16,76)	0.495 (12,58)	0.560 (14,22)
52	0.740 (18,78)	0.761 (19,32)	0.495 (12,58)	0.560 (14,22)
68	0.938 (23,83)	0.962 (24,43)	0.850 (21,6)	0.858 (21,8)
84	1.141 (28,99)	1.165 (29,59)	1.047 (26,6)	1.063 (27,0)



4040140/D 01/11

- NOTES:
- All linear dimensions are in inches (millimeters).
  - This drawing is subject to change without notice.
  - This package can be hermetically sealed with a metal lid.
  - Falls within JEDEC MS-004

N (R-PDIP-T\*\*)

PLASTIC DUAL-IN-LINE PACKAGE

16 PINS SHOWN



- NOTES:
- A. All linear dimensions are in inches (millimeters).
  - B. This drawing is subject to change without notice.
  - Falls within JEDEC MS-001, except 18 and 20 pin minimum body length (Dim A).
  - The 20 pin end lead shoulder width is a vendor option, either half or full width.

DGV (R-PDSO-G\*\*)

PLASTIC SMALL-OUTLINE

24 PINS SHOWN



- NOTES: A. All linear dimensions are in millimeters.  
 B. This drawing is subject to change without notice.  
 C. Body dimensions do not include mold flash or protrusion, not to exceed 0,15 per side.  
 D. Falls within JEDEC: 24/48 Pins – MO-153  
 14/16/20/56 Pins – MO-194



DW (R-PDSO-G20)

PLASTIC SMALL OUTLINE



- NOTES:
- All linear dimensions are in inches (millimeters). Dimensioning and tolerancing per ASME Y14.5M-1994.
  - This drawing is subject to change without notice.
  - Body dimensions do not include mold flash or protrusion not to exceed 0.006 (0,15).
  - Falls within JEDEC MS-013 variation AC.

DW (R-PDSO-G20)

PLASTIC SMALL OUTLINE

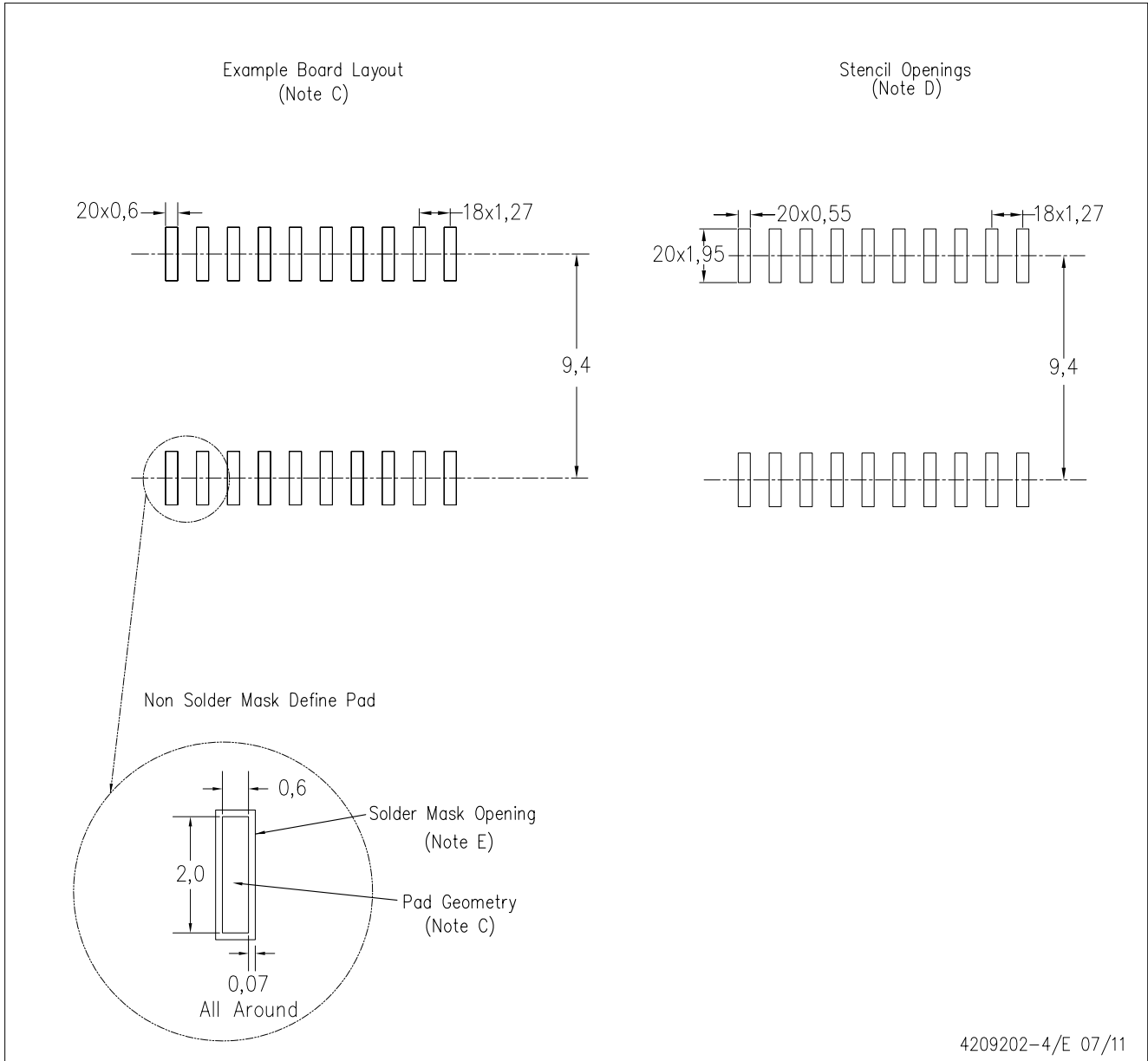

4209202-4/E 07/11

- NOTES:
- A. All linear dimensions are in millimeters.
  - B. This drawing is subject to change without notice.
  - C. Refer to IPC7351 for alternate board design.
  - D. Laser cutting apertures with trapezoidal walls and also rounding corners will offer better paste release. Customers should contact their board assembly site for stencil design recommendations. Refer to IPC-7525
  - E. Customers should contact their board fabrication site for solder mask tolerances between and around signal pads.

PW (R-PDSO-G20)

PLASTIC SMALL OUTLINE



4040064-5/G 02/11

- NOTES:
- A. All linear dimensions are in millimeters. Dimensioning and tolerancing per ASME Y14.5M-1994.
  - B. This drawing is subject to change without notice.
  - C. Body length does not include mold flash, protrusions, or gate burrs. Mold flash, protrusions, or gate burrs shall not exceed 0,15 each side.
  - D. Body width does not include interlead flash. Interlead flash shall not exceed 0,25 each side.
  - E. Falls within JEDEC MO-153

PW (R-PDSO-G20)

PLASTIC SMALL OUTLINE

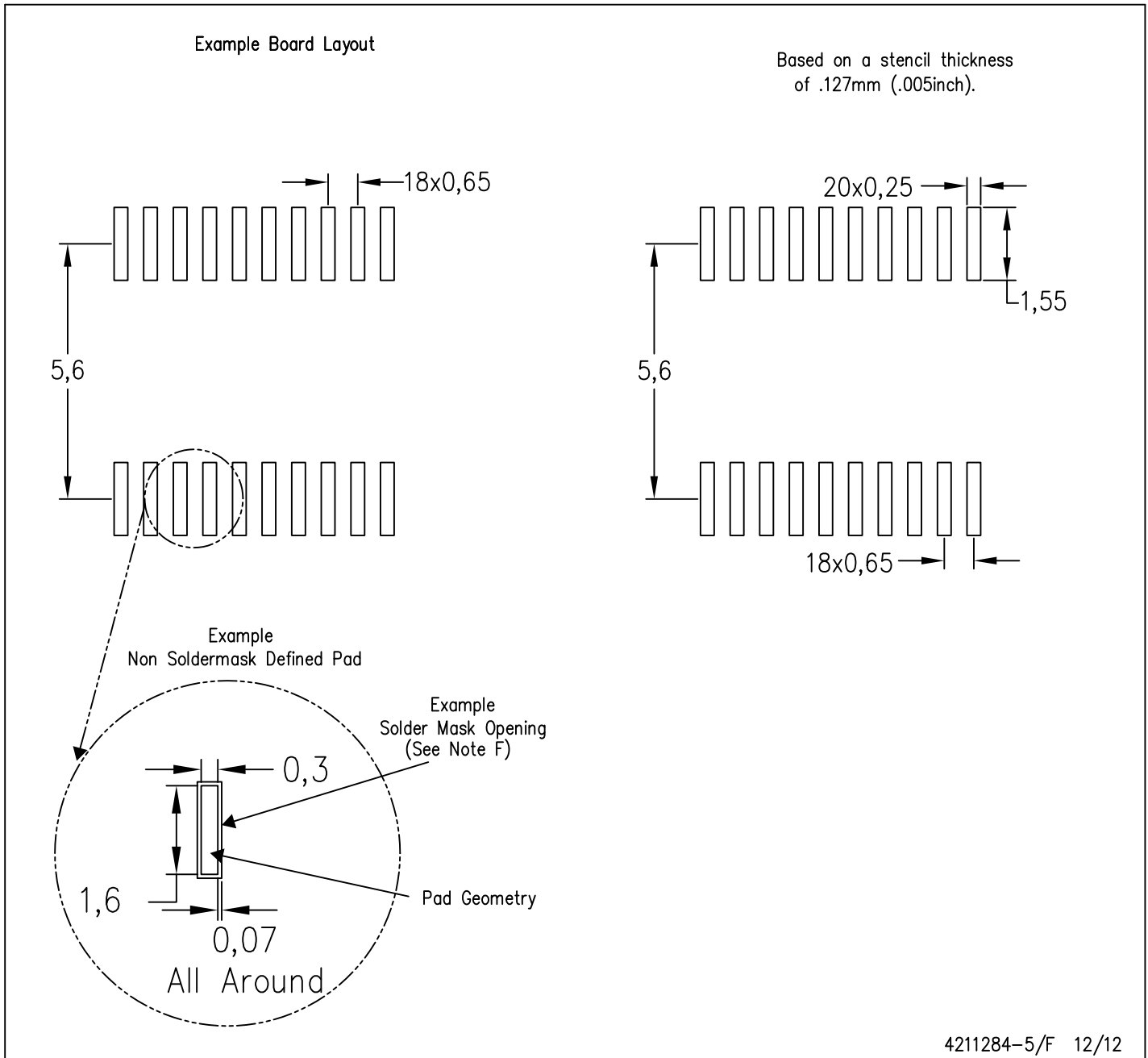

- NOTES:
- A. All linear dimensions are in millimeters.
  - B. This drawing is subject to change without notice.
  - C. Publication IPC-7351 is recommended for alternate design.
  - D. Laser cutting apertures with trapezoidal walls and also rounding corners will offer better paste release. Customers should contact their board assembly site for stencil design recommendations. Refer to IPC-7525 for other stencil recommendations.
  - E. Customers should contact their board fabrication site for solder mask tolerances between and around signal pads.

# MECHANICAL DATA

NS (R-PDSO-G\*\*)

PLASTIC SMALL-OUTLINE PACKAGE

14-PINS SHOWN



- NOTES:
- A. All linear dimensions are in millimeters.
  - B. This drawing is subject to change without notice.
  - C. Body dimensions do not include mold flash or protrusion, not to exceed 0,15.

DB (R-PDSO-G\*\*)

PLASTIC SMALL-OUTLINE

28 PINS SHOWN



- NOTES: A. All linear dimensions are in millimeters.  
 B. This drawing is subject to change without notice.  
 C. Body dimensions do not include mold flash or protrusion not to exceed 0,15.  
 D. Falls within JEDEC MO-150

## IMPORTANT NOTICE

Texas Instruments Incorporated and its subsidiaries (TI) reserve the right to make corrections, enhancements, improvements and other changes to its semiconductor products and services per JESD46, latest issue, and to discontinue any product or service per JESD48, latest issue. Buyers should obtain the latest relevant information before placing orders and should verify that such information is current and complete. All semiconductor products (also referred to herein as "components") are sold subject to TI's terms and conditions of sale supplied at the time of order acknowledgment.

TI warrants performance of its components to the specifications applicable at the time of sale, in accordance with the warranty in TI's terms and conditions of sale of semiconductor products. Testing and other quality control techniques are used to the extent TI deems necessary to support this warranty. Except where mandated by applicable law, testing of all parameters of each component is not necessarily performed.

TI assumes no liability for applications assistance or the design of Buyers' products. Buyers are responsible for their products and applications using TI components. To minimize the risks associated with Buyers' products and applications, Buyers should provide adequate design and operating safeguards.

TI does not warrant or represent that any license, either express or implied, is granted under any patent right, copyright, mask work right, or other intellectual property right relating to any combination, machine, or process in which TI components or services are used. Information published by TI regarding third-party products or services does not constitute a license to use such products or services or a warranty or endorsement thereof. Use of such information may require a license from a third party under the patents or other intellectual property of the third party, or a license from TI under the patents or other intellectual property of TI.

Reproduction of significant portions of TI information in TI data books or data sheets is permissible only if reproduction is without alteration and is accompanied by all associated warranties, conditions, limitations, and notices. TI is not responsible or liable for such altered documentation. Information of third parties may be subject to additional restrictions.

Resale of TI components or services with statements different from or beyond the parameters stated by TI for that component or service voids all express and any implied warranties for the associated TI component or service and is an unfair and deceptive business practice. TI is not responsible or liable for any such statements.

Buyer acknowledges and agrees that it is solely responsible for compliance with all legal, regulatory and safety-related requirements concerning its products, and any use of TI components in its applications, notwithstanding any applications-related information or support that may be provided by TI. Buyer represents and agrees that it has all the necessary expertise to create and implement safeguards which anticipate dangerous consequences of failures, monitor failures and their consequences, lessen the likelihood of failures that might cause harm and take appropriate remedial actions. Buyer will fully indemnify TI and its representatives against any damages arising out of the use of any TI components in safety-critical applications.

In some cases, TI components may be promoted specifically to facilitate safety-related applications. With such components, TI's goal is to help enable customers to design and create their own end-product solutions that meet applicable functional safety standards and requirements. Nonetheless, such components are subject to these terms.

No TI components are authorized for use in FDA Class III (or similar life-critical medical equipment) unless authorized officers of the parties have executed a special agreement specifically governing such use.

Only those TI components which TI has specifically designated as military grade or "enhanced plastic" are designed and intended for use in military/aerospace applications or environments. Buyer acknowledges and agrees that any military or aerospace use of TI components which have **not** been so designated is solely at the Buyer's risk, and that Buyer is solely responsible for compliance with all legal and regulatory requirements in connection with such use.

TI has specifically designated certain components as meeting ISO/TS16949 requirements, mainly for automotive use. In any case of use of non-designated products, TI will not be responsible for any failure to meet ISO/TS16949.

### Products

Audio	<a href="http://www.ti.com/audio">www.ti.com/audio</a>
Amplifiers	<a href="http://amplifier.ti.com">amplifier.ti.com</a>
Data Converters	<a href="http://dataconverter.ti.com">dataconverter.ti.com</a>
DLP® Products	<a href="http://www.dlp.com">www.dlp.com</a>
DSP	<a href="http://dsp.ti.com">dsp.ti.com</a>
Clocks and Timers	<a href="http://www.ti.com/clocks">www.ti.com/clocks</a>
Interface	<a href="http://interface.ti.com">interface.ti.com</a>
Logic	<a href="http://logic.ti.com">logic.ti.com</a>
Power Mgmt	<a href="http://power.ti.com">power.ti.com</a>
Microcontrollers	<a href="http://microcontroller.ti.com">microcontroller.ti.com</a>
RFID	<a href="http://www.ti-rfid.com">www.ti-rfid.com</a>
OMAP Applications Processors	<a href="http://www.ti.com/omap">www.ti.com/omap</a>
Wireless Connectivity	<a href="http://www.ti.com/wirelessconnectivity">www.ti.com/wirelessconnectivity</a>

### Applications

Automotive and Transportation	<a href="http://www.ti.com/automotive">www.ti.com/automotive</a>
Communications and Telecom	<a href="http://www.ti.com/communications">www.ti.com/communications</a>
Computers and Peripherals	<a href="http://www.ti.com/computers">www.ti.com/computers</a>
Consumer Electronics	<a href="http://www.ti.com/consumer-apps">www.ti.com/consumer-apps</a>
Energy and Lighting	<a href="http://www.ti.com/energy">www.ti.com/energy</a>
Industrial	<a href="http://www.ti.com/industrial">www.ti.com/industrial</a>
Medical	<a href="http://www.ti.com/medical">www.ti.com/medical</a>
Security	<a href="http://www.ti.com/security">www.ti.com/security</a>
Space, Avionics and Defense	<a href="http://www.ti.com/space-avionics-defense">www.ti.com/space-avionics-defense</a>
Video and Imaging	<a href="http://www.ti.com/video">www.ti.com/video</a>

### TI E2E Community

[e2e.ti.com](http://e2e.ti.com)