

SN54LS299, SN54S299, SN74LS299, SN74S299 8-BIT UNIVERSAL SHIFT/STORAGE REGISTERS

SDLS156 – MARCH 1974 – REVISED MARCH 1988

- Multiplexed Inputs/Outputs Provide Improved Bit Density
- Four Modes of Operations:

Hold (Store)	Shift Left
Shift Right	Load Data
- Operates with Outputs Enabled or at High Z
- 3-State Outputs Drive Bus Lines Directly
- Can Be Cascaded for N-Bit Word Lengths
- SN54LS323 and SN74LS323 Are Similar But Have Synchronous Clear

SN54LS299, SN54S299 . . . J OR W PACKAGE
SN74LS299, SN74S299 . . . DW OR N PACKAGE
(TOP VIEW)

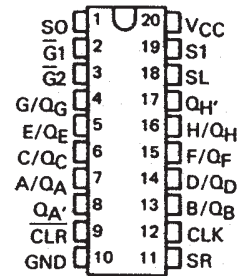

- Applications:
 - Stacked or Push-Down Registers
 - Buffer Storage, and Accumulator Registers

TYPE	GUARANTEED	TYPICAL
	SHIFT (CLOCK) FREQUENCY	POWER DISSIPATION
'LS299	25 MHz	175 mW
'S299	50 MHz	700 mW

SN54LS299, SN54S299 . . . FK PACKAGE
(TOP VIEW)

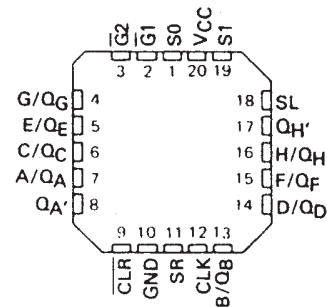

description

These Schottky TTL eight-bit universal registers feature multiplexed inputs/outputs to achieve full eight-bit data handling in a single 20-pin package. Two function-select inputs and two output-control inputs can be used to choose the modes of operation listed in the function table.

Synchronous parallel loading is accomplished by taking both function-select lines, S0 and S1, high. This places the three-state outputs in a high-impedance state, which permits data that is applied on the input/output lines to be clocked into the register. Reading out of the register can be accomplished while the outputs are enabled in any mode. A direct overriding input is provided to clear the register whether the outputs are enabled or off.

FUNCTION TABLE

MODE	INPUTS						INPUTS/OUTPUTS								OUTPUTS			
	CLR	FUNCTION SELECT		OUTPUT CONTROL		CLK	SERIAL		A/QA	B/QB	C/QC	D/QD	E/QE	F/QF	G/QG	H/QH	QA'	QH'
		S1	S0	G1†	G2†		SL	SR										
Clear	L	X	L	L	L	X	X	X	L	L	L	L	L	L	L	L	L	L
	L	L	X	L	L	X	X	X	L	L	L	L	L	L	L	L	L	L
	L	H	H	X	X	X	X	X	X	X	X	X	X	X	X	X	X	X
Hold	H	L	L	L	L	X	X	X	QA0	QB0	QC0	QD0	QE0	QF0	QG0	QH0	QA0	QH0
	H	X	X	L	L	L	X	X	QA0	QB0	QC0	QD0	QE0	QF0	QG0	QH0	QA0	QH0
Shift Right	H	L	H	L	L	†	X	H	H	QA _n	QB _n	QC _n	QD _n	QE _n	QF _n	QG _n	H	QH _n
	H	L	H	L	L	†	X	L	L	QA _n	QB _n	QC _n	QD _n	QE _n	QF _n	QG _n	L	QH _n
Shift Left	H	H	L	L	L	†	H	X	QB _n	QC _n	QD _n	QE _n	QF _n	QG _n	QH _n	H	QB _n	H
	H	H	L	L	L	†	L	X	QB _n	QC _n	QD _n	QE _n	QF _n	QG _n	QH _n	L	QB _n	L
Load	H	H	H	X	X	†	X	X	a	b	c	d	e	f	g	h	a	h

† When one or both output controls are high the eight input/output terminals are disabled to the high-impedance state; however, sequential operation or clearing of the register is not affected.

a . . . h = the level of the steady-state input at inputs A through H, respectively. These data are loaded into the flip-flops while the flip-flop outputs are isolated from the input/output terminals.

PRODUCTION DATA information is current as of publication date. Products conform to specifications per the terms of Texas Instruments standard warranty. Production processing does not necessarily include testing of all parameters.



POST OFFICE BOX 655303 • DALLAS, TEXAS 75265

Copyright © 1988, Texas Instruments Incorporated

SN54LS299, SN54S299, SN74LS299, SN74S299 8-BIT UNIVERSAL SHIFT/STORAGE REGISTERS

SDLS156 – MARCH 1974 – REVISED MARCH 1988

logic symbol†

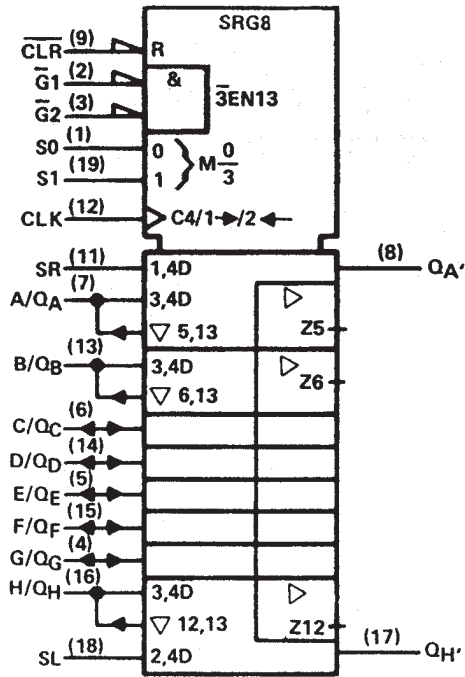

† This symbol is in accordance with ANSI/IEEE Std 91-1984 and IEC Publication 617-12. Pin numbers shown are for DW, J, N, and W packages.

logic diagram (positive logic)

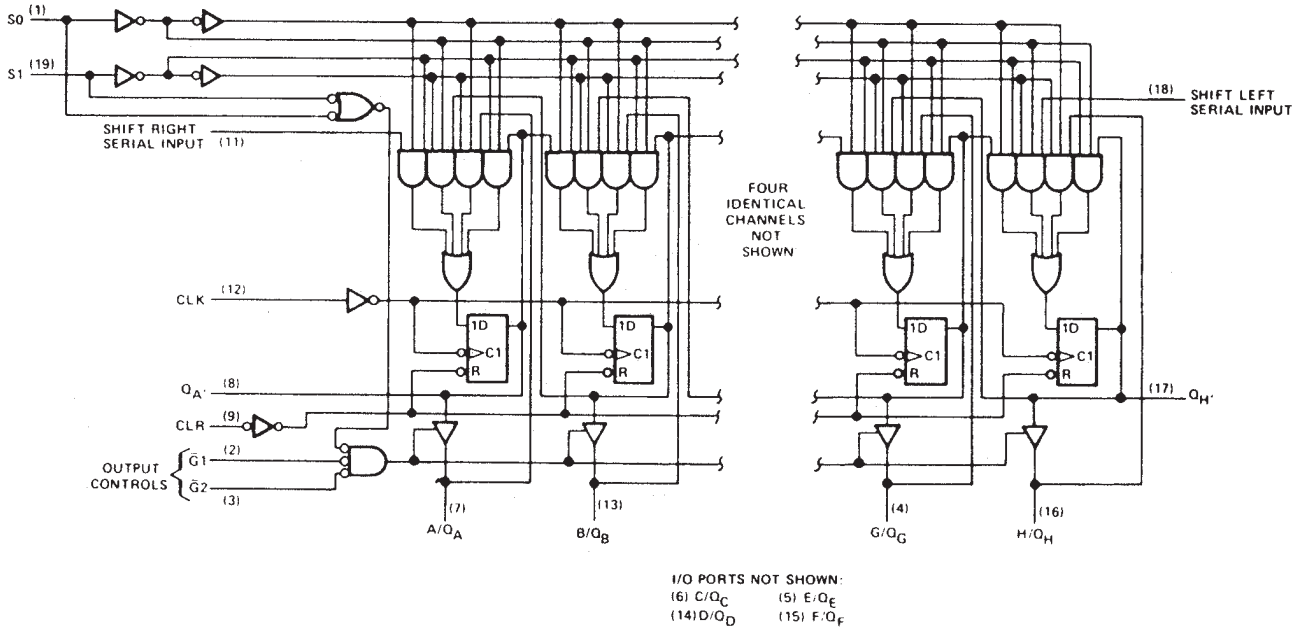

Pin numbers shown are for DW, J, N, and W packages.



POST OFFICE BOX 655303 • DALLAS, TEXAS 75265

SN54LS299, SN54S299, SN74LS299, SN74S299 8-BIT UNIVERSAL SHIFT/STORAGE REGISTERS

SDLS156 – MARCH 1974 – REVISED MARCH 1988

schematics of inputs and outputs

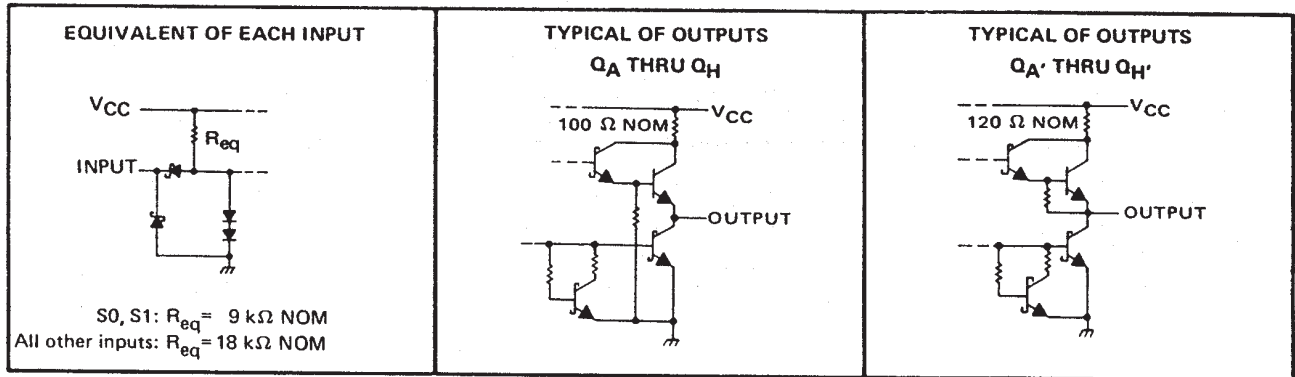

absolute maximum ratings over operating free-air temperature range (unless otherwise noted)

Supply voltage, V_{CC} (see Note 1)	7 V
Input voltage	7 V
Off-state output voltage	5.5 V
Operating free-air temperature range: SN54LS299	-55°C to 125°C
SN74LS299	0°C to 70°C
Storage temperature	-65°C to 150°C

NOTE 1: Voltage values are with respect to network ground terminal.

recommended operating conditions

		SN54LS299			SN74LS299			UNIT
		MIN	NOM	MAX	MIN	NOM	MAX	
Supply voltage, V_{CC}		4.5	5	5.5	4.75	5	5.25	V
High-level output current, I_{OH}	Q_A thru Q_H			-1			-2.6	mA
	Q_A' or Q_H'			-0.4			-0.4	
Low-level output current, I_{OL}	Q_A thru Q_H			12			24	mA
	Q_A' or Q_H'			4			8	
Clock frequency, f_{clock}		0		20	0		20	MHz
Width of clock pulse, $t_w(\text{clock})$	Clock high	30			30			ns
	Clock low	18			10			
Width of clear pulse, $t_w(\text{clear})$	Clear low	25			20			ns
	Clear high							
Setup time, t_{su}	Select	35 [†]			35 [†]			ns
	High-level data [†]	20 [†]			20 [†]			
	Low-level data [†]	20 [†]			20 [†]			
	Clear inactive-state	24 [†]			20 [†]			
Hold time, t_h	Select	10 [†]			10 [†]			ns
	Data [†]	3 [†]			0 [†]			
Operating free-air temperature, T_A		-55		125	0		70	$^{\circ}\text{C}$

[†] Data includes the two serial inputs and the eight input/output data lines.

SN54LS299, SN54S299, SN74LS299, SN74S299 8-BIT UNIVERSAL SHIFT/STORAGE REGISTERS

SDLS156 – MARCH 1974 – REVISED MARCH 1988

electrical characteristics over recommended operating free-air temperature range (unless otherwise noted)

PARAMETER		TEST CONDITIONS†	SN54LS299		SN74LS299		UNIT			
			MIN	TYP‡	MAX	MIN		TYP‡	MAX	
V _{IH}	High-level input voltage		2		2		V			
V _{IL}	Low-level input voltage				0.7		0.8	V		
V _{IK}	Input clamp voltage	V _{CC} = MIN, I _I = -18 mA			-1.5		-1.5	V		
V _{OH}	High-level output voltage	Q _A thru Q _H	V _{CC} = MIN, V _{IH} = 2 V,		2.4	3.2	2.4	3.1	V	
		Q _A ' or Q _H '	V _{IL} = V _{ILmax} , I _{OH} = MAX		2.5	3.4	2.7	3.4		
V _{OL}	Low-level output voltage	Q _A thru Q _H	V _{CC} = MIN, V _{IH} = 2 V, V _{IL} = V _{ILmax}	I _{OL} = 12 mA	0.25	0.4	0.25	0.4	V	
				I _{OL} = 24 mA			0.35	0.5		
		Q _A ' or Q _H '		I _{OL} = 4 mA	0.25	0.4	0.25	0.4		
				I _{OL} = 8 mA			0.35	0.5		
I _{OZH}	Off-state output current, high-level voltage applied	Q _A thru Q _H	V _{CC} = MAX, V _O = 2.7 V, V _{IH} = 2 V,		40		40	μA		
I _{OZL}	Off-state output current, low-level voltage applied	Q _A thru Q _H	V _{CC} = MAX, V _O = 0.4 V, V _{IH} = 2 V,		-400		-400	μA		
I _I	Input current at maximum input voltage	S0, S1	V _{CC} = MAX	V _I = 7 V		200		200	μA	
		A thru H		V _I = 5.5 V		100		100		
		Any other		V _I = 7 V		100		100		
I _{IH}	High-level input current	A thru H, S0, S1	V _{CC} = MAX, V _I = 2.7 V			40		40	μA	
		Any other				20		20		
I _{IL}	Low-level input current	S0, S1	V _{CC} = MAX, V _I = 0.4 V			-0.8		-0.8	mA	
		Any other				-0.4		-0.4		
I _{OS}	Short-circuit output current§	Q _A thru Q _H	V _{CC} = MAX		-30	-130	-30	-130	mA	
		Q _A ' or Q _H '			-20	-100	-20	-100		
I _{CC}	Supply current		V _{CC} = MAX		33	53		33	53	mA

† For conditions shown as MIN or MAX, use the appropriate value specified under recommended operating conditions.

‡ All typical values are at V_{CC} = 5 V, T_A = 25°C.

§ Not more than one output should be shorted at a time and duration of the short-circuit should not exceed one second.

switching characteristics, V_{CC} = 5 V, T_A = 25°C

PARAMETER¶	FROM (INPUT)	TO (OUTPUT)	TEST CONDITIONS	MIN	TYP	MAX	UNIT
f _{max}			See Note 2	20	35		MHz
t _{PLH}	CLK	Q _A ' or Q _H '	R _L = 2 kΩ, C _L = 15 pF		22	33	ns
t _{PHL}					26	39	
t _{PHL}				CLR		27	
t _{PLH}	CLK	Q _A thru Q _H	R _L = 665 Ω, C _L = 45 pF		17	25	ns
t _{PHL}					26	39	
t _{PHL}				CLR		26	
t _{PZH}	G1, G2	Q _A thru Q _H			13	21	ns
t _{PZL}					19	30	
t _{PHZ}	G1, G2	Q _A thru Q _H	R _L = 665 Ω, C _L = 5 pF		10	20	ns
t _{PLZ}					10	15	

¶ f_{max} ≡ maximum clock frequency

t_{PLH} ≡ propagation delay time, low-to-high-level output.

t_{PHL} ≡ propagation delay time, high-to-low-level output

t_{PZH} ≡ output enable time to high level

t_{PZL} ≡ output enable time to low level

t_{PHZ} ≡ output disable time from high level

t_{PLZ} ≡ output disable time from low level

NOTE 2: For testing f_{max}, all outputs are loaded simultaneously, each with C_L and R_L as specified for the propagation times.

Load circuits and voltage waveforms are shown in Section 1.



POST OFFICE BOX 655303 • DALLAS, TEXAS 75265

SN54LS299, SN54S299, SN74LS299, SN74S299 8-BIT UNIVERSAL SHIFT/STORAGE REGISTERS

SDLS156 – MARCH 1974 – REVISED MARCH 1988

schematics of inputs and outputs

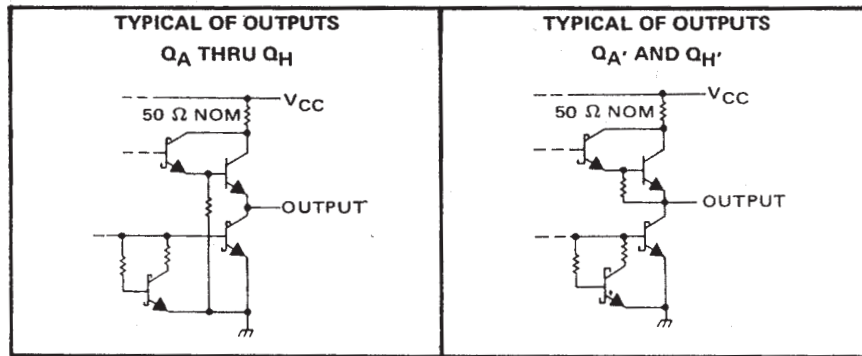
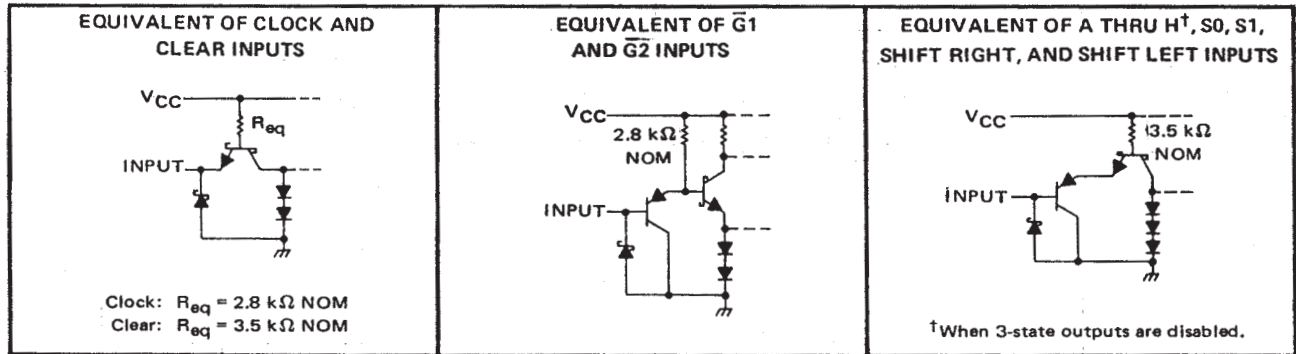

absolute maximum ratings over operating free-air temperature range (unless otherwise noted)

Supply voltage, V_{CC} (see Note 1)	7 V
Input voltage	5.5 V
Off-state output voltage	5.5 V
Operating free-air temperature range: SN54S299 (See Note 1)	-55 °C to 125 °C
SN74S299	0 °C to 70 °C
Storage temperature range	-65 °C to 150 °C

NOTE 1: Voltage values are with respect to network ground terminal.

recommended operating conditions

		SN54S299			SN74S299			UNIT
		MIN	NOM	MAX	MIN	NOM	MAX	
Supply voltage, V_{CC}		4.5	5	5.5	4.75	5	5.25	V
High-level output current, I_{OH}	Q_A thru Q_H			-2			-6.5	mA
	$Q_{A'}$ or $Q_{H'}$			-0.5			-0.5	
Low-level output current, I_{OL}	Q_A thru Q_H			20			20	mA
	$Q_{A'}$ or $Q_{H'}$			6			6	
Clock frequency, f_{clock}		0		50	0		50	MHz
Width of clock pulse, $t_{w(clock)}$	Clock high	10			10			ns
	Clock low	10			10			
Width of clear pulse, $t_{w(clear)}$	Clear low	10			10			ns
Setup time, t_{SU}	Select	15 [†]			15 [†]			ns
	High-level data [‡]	7 [†]			7 [†]			
	Low-level data [‡]	5 [†]			5 [†]			
	Clear inactive-state	10 [†]			10 [†]			
Hold time, t_H	Select	5 [†]			5 [†]			ns
	Data [‡]	5 [†]			5 [†]			
Operating free-air temperature, T_A		-55		125	0		70	°C

[†] Data includes the two serial inputs and the eight input/output data lines.



POST OFFICE BOX 655303 • DALLAS, TEXAS 75265

SN54LS299, SN54S299, SN74LS299, SN74S299 8-BIT UNIVERSAL SHIFT/STORAGE REGISTERS

SDLS156 – MARCH 1974 – REVISED MARCH 1988

electrical characteristics over recommended operating free-air temperature range (unless otherwise noted)

PARAMETER		TEST CONDITIONS†	MIN	TYP‡	MAX	UNIT	
V _{IH}	High-level input voltage		2			V	
V _{IL}	Low-level input voltage				0.8	V	
V _{IK}	Input clamp voltage	V _{CC} = MIN, I _I = -18 mA			-1.2	V	
V _{OH}	High-level output voltage	Q _A thru Q _H	V _{CC} = MIN, V _{IH} = 2 V,	2.4	3.2	V	
		Q _A ' or Q _H '	V _{IL} = 0.8 V, I _{OH} = MAX	2.7	3.4		
V _{OL}	Low-level output voltage	V _{CC} = MIN, V _{IH} = 2 V, V _{IL} = 0.8 V, I _{OL} = MAX			0.5	V	
I _{OZH}	Off-state output current, high-level voltage applied	Q _A thru Q _H	V _{CC} = MAX, V _{IH} = 2 V, V _O = 2.4 V		100	μA	
I _{OZL}	Off-state output current, low-level voltage applied	Q _A thru Q _H	V _{CC} = MAX, V _{IH} = 2 V, V _O = 0.5 V		-250	μA	
I _I	Input current at maximum input voltage	V _{CC} = MAX, V _I = 5.5 V			1	mA	
I _{IH}	High-level input current	A thru H, S0, S1	V _{CC} = MAX, V _I = 2.7 V		100	μA	
		Any other			50		
I _{IL}	Low-level input current	CLK or CLR	V _{CC} = MAX, V _I = 0.5 V		-2	mA	
		S0, S1			-500	μA	
		Any other			-250	μA	
I _{OS}	Short-circuit output current §	Q _A thru Q _H	V _{CC} = MAX		-40	-100	mA
		Q _A ' or Q _H '			-20	-100	
I _{CC}	Supply current	V _{CC} = MAX		140	225	mA	

† For conditions shown as MIN or MAX, use the appropriate value specified under recommended operating conditions.

‡ All typical values are at V_{CC} = 5 V, T_A = 25°C.

§ Not more than one output should be shorted at a time and duration of the short-circuit should not exceed one second.

switching characteristics, V_{CC} = 5 V, T_A = 25°C

PARAMETER¶	FROM (INPUT)	TO (OUTPUT)	TEST CONDITIONS	MIN	TYP	MAX	UNIT
f _{max}			See Note 2	50	70		MHz
t _{PLH}	CLK	Q _A ' or Q _H '	R _L = 1 kΩ, C _L = 15 pF		12	20	ns
t _{PHL}					13	20	
t _{PHL}	CLR	Q _A ' or Q _H '			14	21	ns
t _{PLH}	CLK	Q _A thru Q _H	R _L = 280 Ω, C _L = 45 pF		15	21	ns
t _{PHL}					15	21	
t _{PHL}	CLR	Q _A thru Q _H	R _L = 280 Ω, C _L = 45 pF		16	24	ns
t _{PZH}					10	18	
t _{PZL}	G1, G2	Q _A thru Q _H	R _L = 280 Ω, C _L = 5 pF		12	18	ns
t _{PHZ}					7	12	
t _{PLZ}	G1, G2	Q _A thru Q _H	R _L = 280 Ω, C _L = 5 pF		7	12	ns

¶ f_{max} = maximum clock frequency

t_{PLH} = Propagation delay time, low-to-high-level output

t_{PHL} = Propagation delay time, high-to-low-level output

t_{PZH} = output enable time to high level

t_{PZL} = output enable time to low level

t_{PHZ} = output disable time from high level

t_{PLZ} = output disable time from low level

NOTE 2: For testing f_{max}, all outputs are loaded simultaneously, each with C_L and R_L as specified for the propagation times.

Load circuits and voltage waveforms are shown in Section 1.



POST OFFICE BOX 655303 • DALLAS, TEXAS 75265

PACKAGING INFORMATION

Orderable Device	Status ⁽¹⁾	Package Type	Package Drawing	Pins	Package Qty	Eco Plan ⁽²⁾	Lead/ Ball Finish	MSL Peak Temp ⁽³⁾	Samples (Requires Login)
78024012A	ACTIVE	LCCC	FK	20	1	TBD	Call TI	Call TI	
7802401RA	ACTIVE	CDIP	J	20	1	TBD	Call TI	Call TI	
7802401RA	ACTIVE	CDIP	J	20	1	TBD	Call TI	Call TI	
7802401SA	ACTIVE	CFP	W	20	1	TBD	Call TI	Call TI	
7802401SA	ACTIVE	CFP	W	20	1	TBD	Call TI	Call TI	
SN54LS299J	ACTIVE	CDIP	J	20	1	TBD	A42	N / A for Pkg Type	
SN54LS299J	ACTIVE	CDIP	J	20	1	TBD	A42	N / A for Pkg Type	
SN54S299J	OBSOLETE	CDIP	J	20		TBD	Call TI	Call TI	
SN54S299J	OBSOLETE	CDIP	J	20		TBD	Call TI	Call TI	
SN74LS299DW	ACTIVE	SOIC	DW	20	25	Green (RoHS & no Sb/Br)	CU NIPDAU	Level-1-260C-UNLIM	
SN74LS299DW	ACTIVE	SOIC	DW	20	25	Green (RoHS & no Sb/Br)	CU NIPDAU	Level-1-260C-UNLIM	
SN74LS299DWE4	ACTIVE	SOIC	DW	20	25	Green (RoHS & no Sb/Br)	CU NIPDAU	Level-1-260C-UNLIM	
SN74LS299DWE4	ACTIVE	SOIC	DW	20	25	Green (RoHS & no Sb/Br)	CU NIPDAU	Level-1-260C-UNLIM	
SN74LS299DWG4	ACTIVE	SOIC	DW	20	25	Green (RoHS & no Sb/Br)	CU NIPDAU	Level-1-260C-UNLIM	
SN74LS299DWG4	ACTIVE	SOIC	DW	20	25	Green (RoHS & no Sb/Br)	CU NIPDAU	Level-1-260C-UNLIM	
SN74LS299N	ACTIVE	PDIP	N	20	20	Pb-Free (RoHS)	CU NIPDAU	N / A for Pkg Type	
SN74LS299N	ACTIVE	PDIP	N	20	20	Pb-Free (RoHS)	CU NIPDAU	N / A for Pkg Type	
SN74LS299NE4	ACTIVE	PDIP	N	20	20	Pb-Free (RoHS)	CU NIPDAU	N / A for Pkg Type	
SN74LS299NE4	ACTIVE	PDIP	N	20	20	Pb-Free (RoHS)	CU NIPDAU	N / A for Pkg Type	
SN74S299DW	OBSOLETE	SOIC	DW	20		TBD	Call TI	Call TI	
SN74S299DW	OBSOLETE	SOIC	DW	20		TBD	Call TI	Call TI	
SN74S299DWR	OBSOLETE	SOIC	DW	20		TBD	Call TI	Call TI	
SN74S299DWR	OBSOLETE	SOIC	DW	20		TBD	Call TI	Call TI	
SN74S299N	OBSOLETE	PDIP	N	20		TBD	Call TI	Call TI	
SN74S299N	OBSOLETE	PDIP	N	20		TBD	Call TI	Call TI	

Orderable Device	Status ⁽¹⁾	Package Type	Package Drawing	Pins	Package Qty	Eco Plan ⁽²⁾	Lead/ Ball Finish	MSL Peak Temp ⁽³⁾	Samples (Requires Login)
SN74S299N3	OBSOLETE	PDIP	N	20		TBD	Call TI	Call TI	
SN74S299N3	OBSOLETE	PDIP	N	20		TBD	Call TI	Call TI	
SNJ54LS299FK	ACTIVE	LCCC	FK	20	1	TBD	POST-PLATE	N / A for Pkg Type	
SNJ54LS299FK	ACTIVE	LCCC	FK	20	1	TBD	POST-PLATE	N / A for Pkg Type	
SNJ54LS299J	ACTIVE	CDIP	J	20	1	TBD	A42	N / A for Pkg Type	
SNJ54LS299J	ACTIVE	CDIP	J	20	1	TBD	A42	N / A for Pkg Type	
SNJ54LS299W	ACTIVE	CFP	W	20	1	TBD	Call TI	N / A for Pkg Type	
SNJ54LS299W	ACTIVE	CFP	W	20	1	TBD	Call TI	N / A for Pkg Type	
SNJ54S299FK	OBSOLETE	LCCC	FK	20		TBD	Call TI	Call TI	
SNJ54S299FK	OBSOLETE	LCCC	FK	20		TBD	Call TI	Call TI	
SNJ54S299J	OBSOLETE	CDIP	J	20		TBD	Call TI	Call TI	
SNJ54S299J	OBSOLETE	CDIP	J	20		TBD	Call TI	Call TI	
SNJ54S299W	OBSOLETE	CFP	W	20		TBD	Call TI	Call TI	
SNJ54S299W	OBSOLETE	CFP	W	20		TBD	Call TI	Call TI	

⁽¹⁾ The marketing status values are defined as follows:

ACTIVE: Product device recommended for new designs.

LIFEBUY: TI has announced that the device will be discontinued, and a lifetime-buy period is in effect.

NRND: Not recommended for new designs. Device is in production to support existing customers, but TI does not recommend using this part in a new design.

PREVIEW: Device has been announced but is not in production. Samples may or may not be available.

OBSOLETE: TI has discontinued the production of the device.

⁽²⁾ Eco Plan - The planned eco-friendly classification: Pb-Free (RoHS), Pb-Free (RoHS Exempt), or Green (RoHS & no Sb/Br) - please check <http://www.ti.com/productcontent> for the latest availability information and additional product content details.

TBD: The Pb-Free/Green conversion plan has not been defined.

Pb-Free (RoHS): TI's terms "Lead-Free" or "Pb-Free" mean semiconductor products that are compatible with the current RoHS requirements for all 6 substances, including the requirement that lead not exceed 0.1% by weight in homogeneous materials. Where designed to be soldered at high temperatures, TI Pb-Free products are suitable for use in specified lead-free processes.

Pb-Free (RoHS Exempt): This component has a RoHS exemption for either 1) lead-based flip-chip solder bumps used between the die and package, or 2) lead-based die adhesive used between the die and leadframe. The component is otherwise considered Pb-Free (RoHS compatible) as defined above.

Green (RoHS & no Sb/Br): TI defines "Green" to mean Pb-Free (RoHS compatible), and free of Bromine (Br) and Antimony (Sb) based flame retardants (Br or Sb do not exceed 0.1% by weight in homogeneous material)

⁽³⁾ MSL, Peak Temp. -- The Moisture Sensitivity Level rating according to the JEDEC industry standard classifications, and peak solder temperature.

Important Information and Disclaimer: The information provided on this page represents TI's knowledge and belief as of the date that it is provided. TI bases its knowledge and belief on information provided by third parties, and makes no representation or warranty as to the accuracy of such information. Efforts are underway to better integrate information from third parties. TI has taken and

continues to take reasonable steps to provide representative and accurate information but may not have conducted destructive testing or chemical analysis on incoming materials and chemicals. TI and TI suppliers consider certain information to be proprietary, and thus CAS numbers and other limited information may not be available for release.

In no event shall TI's liability arising out of such information exceed the total purchase price of the TI part(s) at issue in this document sold by TI to Customer on an annual basis.

OTHER QUALIFIED VERSIONS OF SN54LS299, SN54S299, SN74LS299, SN74S299 :

- Catalog: [SN74LS299](#), [SN74S299](#)
- Military: [SN54LS299](#), [SN54S299](#)

NOTE: Qualified Version Definitions:

- Catalog - TI's standard catalog product
- Military - QML certified for Military and Defense Applications

J (R-GDIP-T**)

14 LEADS SHOWN

CERAMIC DUAL IN-LINE PACKAGE



DIM \ PINS **	14	16	18	20
A	0.300 (7,62) BSC	0.300 (7,62) BSC	0.300 (7,62) BSC	0.300 (7,62) BSC
B MAX	0.785 (19,94)	.840 (21,34)	0.960 (24,38)	1.060 (26,92)
B MIN	—	—	—	—
C MAX	0.300 (7,62)	0.300 (7,62)	0.310 (7,87)	0.300 (7,62)
C MIN	0.245 (6,22)	0.245 (6,22)	0.220 (5,59)	0.245 (6,22)



4040083/F 03/03

- NOTES:
- All linear dimensions are in inches (millimeters).
 - This drawing is subject to change without notice.
 - This package is hermetically sealed with a ceramic lid using glass frit.
 - Index point is provided on cap for terminal identification only on press ceramic glass frit seal only.
 - Falls within MIL STD 1835 GDIP1-T14, GDIP1-T16, GDIP1-T18 and GDIP1-T20.

W (R-GDFP-F20)

CERAMIC DUAL FLATPACK



- NOTES:
- A. All linear dimensions are in inches (millimeters).
 - B. This drawing is subject to change without notice.
 - C. This package can be hermetically sealed with a ceramic lid using glass frit.
 - D. Index point is provided on cap for terminal identification only.
 - E. Falls within Mil-Std 1835 GDFP2-F20

FK (S-CQCC-N**)

LEADLESS CERAMIC CHIP CARRIER

28 TERMINAL SHOWN



NO. OF TERMINALS **	A		B	
	MIN	MAX	MIN	MAX
20	0.342 (8,69)	0.358 (9,09)	0.307 (7,80)	0.358 (9,09)
28	0.442 (11,23)	0.458 (11,63)	0.406 (10,31)	0.458 (11,63)
44	0.640 (16,26)	0.660 (16,76)	0.495 (12,58)	0.560 (14,22)
52	0.740 (18,78)	0.761 (19,32)	0.495 (12,58)	0.560 (14,22)
68	0.938 (23,83)	0.962 (24,43)	0.850 (21,6)	0.858 (21,8)
84	1.141 (28,99)	1.165 (29,59)	1.047 (26,6)	1.063 (27,0)



4040140/D 01/11

- NOTES:
- All linear dimensions are in inches (millimeters).
 - This drawing is subject to change without notice.
 - This package can be hermetically sealed with a metal lid.
 - Falls within JEDEC MS-004

N (R-PDIP-T**)

PLASTIC DUAL-IN-LINE PACKAGE

16 PINS SHOWN



- NOTES:
- A. All linear dimensions are in inches (millimeters).
 - B. This drawing is subject to change without notice.
 - Falls within JEDEC MS-001, except 18 and 20 pin minimum body length (Dim A).
 - The 20 pin end lead shoulder width is a vendor option, either half or full width.

DW (R-PDSO-G20)

PLASTIC SMALL OUTLINE



- NOTES:
- A. All linear dimensions are in inches (millimeters). Dimensioning and tolerancing per ASME Y14.5M-1994.
 - B. This drawing is subject to change without notice.
 - C. Body dimensions do not include mold flash or protrusion not to exceed 0.006 (0,15).
 - D. Falls within JEDEC MS-013 variation AC.

DW (R-PDSO-G20)

PLASTIC SMALL OUTLINE



4209202-4/E 07/11

- NOTES:
- A. All linear dimensions are in millimeters.
 - B. This drawing is subject to change without notice.
 - C. Refer to IPC7351 for alternate board design.
 - D. Laser cutting apertures with trapezoidal walls and also rounding corners will offer better paste release. Customers should contact their board assembly site for stencil design recommendations. Refer to IPC-7525
 - E. Customers should contact their board fabrication site for solder mask tolerances between and around signal pads.

IMPORTANT NOTICE

Texas Instruments Incorporated and its subsidiaries (TI) reserve the right to make corrections, modifications, enhancements, improvements, and other changes to its products and services at any time and to discontinue any product or service without notice. Customers should obtain the latest relevant information before placing orders and should verify that such information is current and complete. All products are sold subject to TI's terms and conditions of sale supplied at the time of order acknowledgment.

TI warrants performance of its hardware products to the specifications applicable at the time of sale in accordance with TI's standard warranty. Testing and other quality control techniques are used to the extent TI deems necessary to support this warranty. Except where mandated by government requirements, testing of all parameters of each product is not necessarily performed.

TI assumes no liability for applications assistance or customer product design. Customers are responsible for their products and applications using TI components. To minimize the risks associated with customer products and applications, customers should provide adequate design and operating safeguards.

TI does not warrant or represent that any license, either express or implied, is granted under any TI patent right, copyright, mask work right, or other TI intellectual property right relating to any combination, machine, or process in which TI products or services are used. Information published by TI regarding third-party products or services does not constitute a license from TI to use such products or services or a warranty or endorsement thereof. Use of such information may require a license from a third party under the patents or other intellectual property of the third party, or a license from TI under the patents or other intellectual property of TI.

Reproduction of TI information in TI data books or data sheets is permissible only if reproduction is without alteration and is accompanied by all associated warranties, conditions, limitations, and notices. Reproduction of this information with alteration is an unfair and deceptive business practice. TI is not responsible or liable for such altered documentation. Information of third parties may be subject to additional restrictions.

Resale of TI products or services with statements different from or beyond the parameters stated by TI for that product or service voids all express and any implied warranties for the associated TI product or service and is an unfair and deceptive business practice. TI is not responsible or liable for any such statements.

TI products are not authorized for use in safety-critical applications (such as life support) where a failure of the TI product would reasonably be expected to cause severe personal injury or death, unless officers of the parties have executed an agreement specifically governing such use. Buyers represent that they have all necessary expertise in the safety and regulatory ramifications of their applications, and acknowledge and agree that they are solely responsible for all legal, regulatory and safety-related requirements concerning their products and any use of TI products in such safety-critical applications, notwithstanding any applications-related information or support that may be provided by TI. Further, Buyers must fully indemnify TI and its representatives against any damages arising out of the use of TI products in such safety-critical applications.

TI products are neither designed nor intended for use in military/aerospace applications or environments unless the TI products are specifically designated by TI as military-grade or "enhanced plastic." Only products designated by TI as military-grade meet military specifications. Buyers acknowledge and agree that any such use of TI products which TI has not designated as military-grade is solely at the Buyer's risk, and that they are solely responsible for compliance with all legal and regulatory requirements in connection with such use.

TI products are neither designed nor intended for use in automotive applications or environments unless the specific TI products are designated by TI as compliant with ISO/TS 16949 requirements. Buyers acknowledge and agree that, if they use any non-designated products in automotive applications, TI will not be responsible for any failure to meet such requirements.

Following are URLs where you can obtain information on other Texas Instruments products and application solutions:

Products

Audio	www.ti.com/audio
Amplifiers	amplifier.ti.com
Data Converters	dataconverter.ti.com
DLP® Products	www.dlp.com
DSP	dsp.ti.com
Clocks and Timers	www.ti.com/clocks
Interface	interface.ti.com
Logic	logic.ti.com
Power Mgmt	power.ti.com
Microcontrollers	microcontroller.ti.com
RFID	www.ti-rfid.com
OMAP Mobile Processors	www.ti.com/omap
Wireless Connectivity	www.ti.com/wirelessconnectivity

Applications

Communications and Telecom	www.ti.com/communications
Computers and Peripherals	www.ti.com/computers
Consumer Electronics	www.ti.com/consumer-apps
Energy and Lighting	www.ti.com/energy
Industrial	www.ti.com/industrial
Medical	www.ti.com/medical
Security	www.ti.com/security
Space, Avionics and Defense	www.ti.com/space-avionics-defense
Transportation and Automotive	www.ti.com/automotive
Video and Imaging	www.ti.com/video

TI E2E Community Home Page

e2e.ti.com

Mailing Address: Texas Instruments, Post Office Box 655303, Dallas, Texas 75265
Copyright © 2011, Texas Instruments Incorporated