

- **4:28 Data Channel Compression at up to 238 MBytes/s Throughput**
- **Suited for SVGA, XGA, or SXGA Display Data Transmission From Controller to Display With Very Low EMI**
- **28 Data Channels and Clock-In Low-Voltage TTL**
- **4 Data Channels and Clock-Out Low-Voltage Differential**
- **Operates From a Single 3.3-V Supply With 250 mW (Typ)**
- **ESD Protection Exceeds 6 kV**
- **5-V Tolerant Data Inputs**
- **Selectable Rising or Falling Edge-Triggered Inputs**
- **Packaged in Thin Shrink Small-Outline Package With 20-Mil Terminal Pitch**
- **Consumes Less Than 1 mW When Disabled**
- **Wide Phase-Lock Input Frequency Range . . . 31 MHz to 68 MHz**
- **No External Components Required for PLL**
- **Outputs Meet or Exceed the Requirements of ANSI EIA/TIA-644 Standard**
- **Improved Replacement for the DS90C581**

**DGG PACKAGE
(TOP VIEW)**

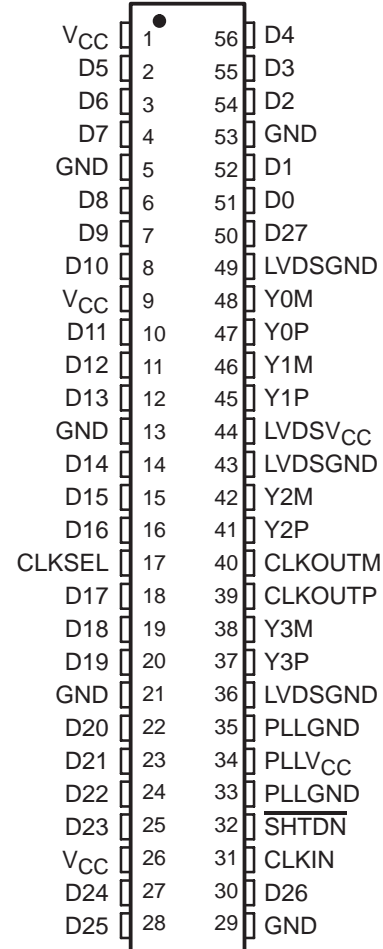

description

The SN75LVDS83 FlatLink transmitter contains four 7-bit parallel-load serial-out shift registers, a 7× clock synthesizer, and five low-voltage differential-signaling (LVDS) line drivers in a single integrated circuit. These functions allow 28 bits of single-ended low-voltage TTL (LVTTTL) data to be synchronously transmitted over five balanced-pair conductors for receipt by a compatible receiver, such as the SN75LVDS82. The SN75LVDS83 can also be used in 21-bit links with the SN75LVDS86 receiver.

When transmitting, data bits D0 through D27 are each loaded into registers upon the edge of the input clock signal (CLKIN). The rising or falling edge of the clock can be selected by way of the clock select (CLKSEL) terminal. The frequency of CLKIN is multiplied seven times (7×) and then used to unload the data registers in 7-bit slices and serially. The four serial streams and a phase-locked clock (CLKOUT) are then output to LVDS output drivers. The frequency of CLKOUT is the same as the input clock, CLKIN.

The SN75LVDS83 requires no external components and little or no control. The data bus appears the same at the input to the transmitter and output of the receiver with the data transmission transparent to the user. The only user intervention is the possible use of the shutdown/clear (SHTDN) active-low input to inhibit the clock and shut off the LVDS output drivers for lower power consumption. A low-level signal on SHTDN clears all internal registers to a low level.

The SN75LVDS83 is characterized for operation over free-air temperature ranges of 0°C to 70°C.



Please be aware that an important notice concerning availability, standard warranty, and use in critical applications of Texas Instruments semiconductor products and disclaimers thereto appears at the end of this data sheet.

FlatLink is a registered trademark of Texas Instruments.

PRODUCTION DATA information is current as of publication date. Products conform to specifications per the terms of Texas Instruments standard warranty. Production processing does not necessarily include testing of all parameters.



Copyright © 1997 – 2009, Texas Instruments Incorporated

SN75LVDS83 FlatLink™ TRANSMITTER

SLLS2711 – MARCH 1997 – REVISED MAY 2009

functional block diagram

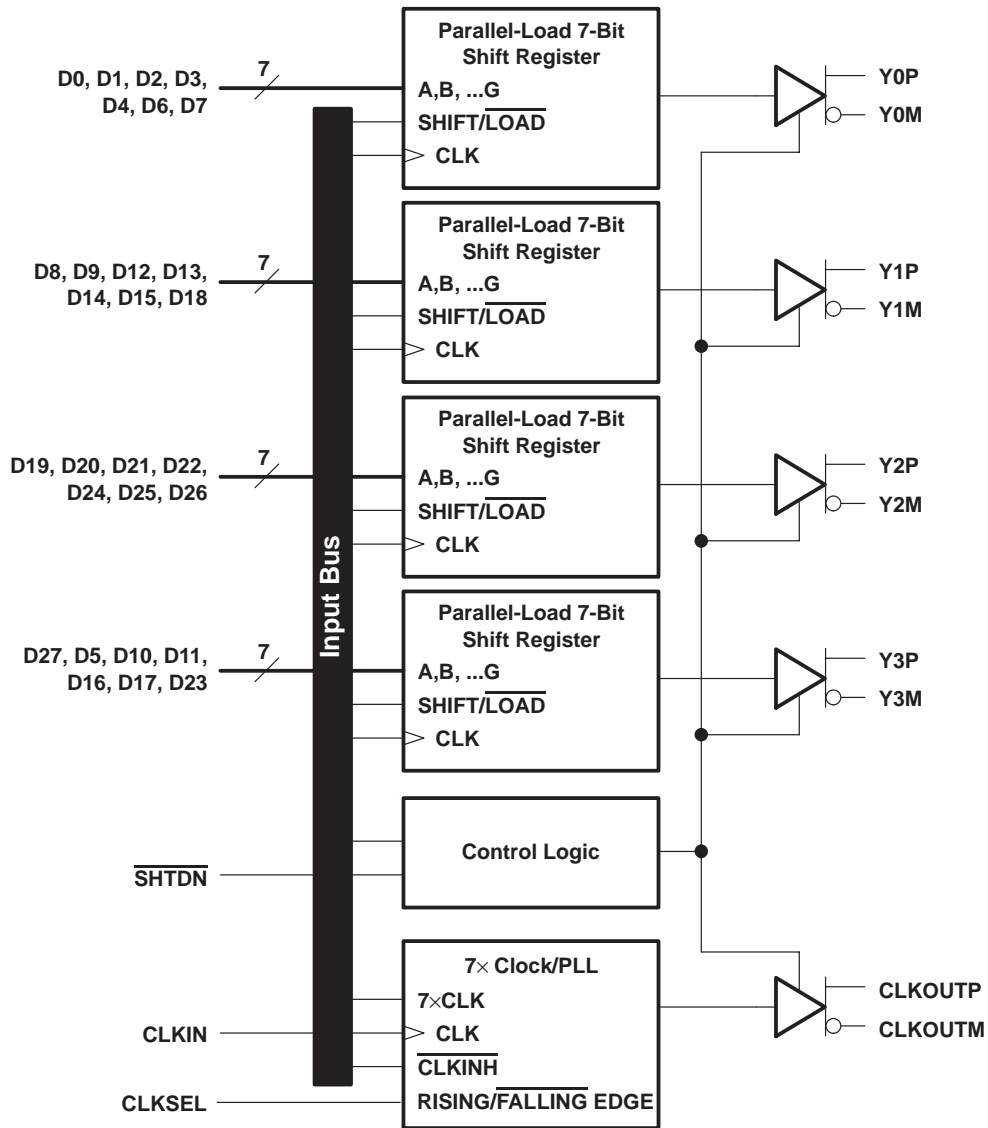

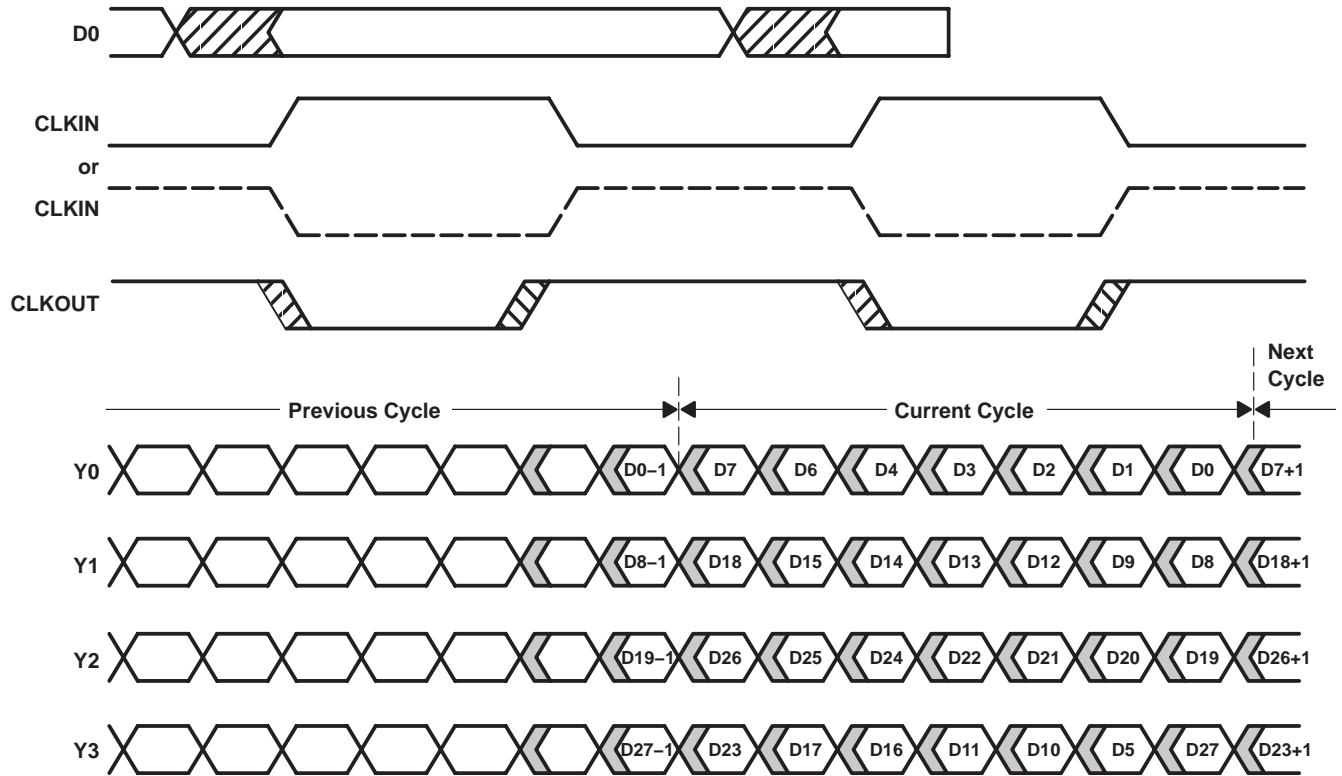
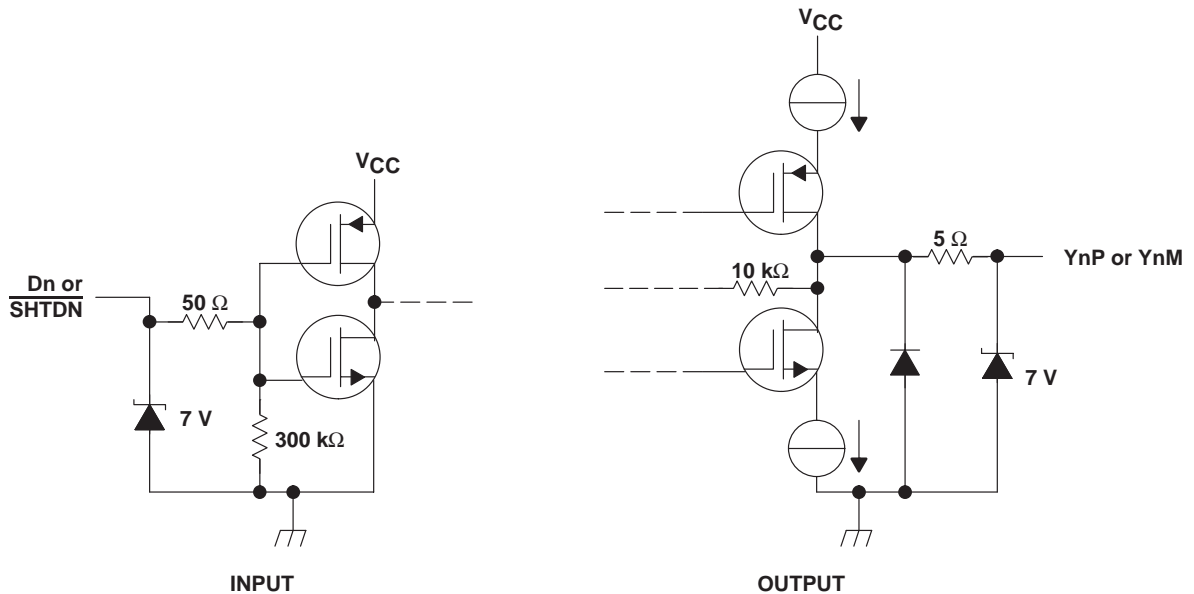

Figure 1. SN75LVDS83 Load and Shift Timing Sequences

equivalent input and output schematic diagrams



SN75LVDS83

FlatLink™ TRANSMITTER

SLLS2711 – MARCH 1997 – REVISED MAY 2009

absolute maximum ratings over operating free-air temperature (unless otherwise noted)†

Supply voltage range, V_{CC} (see Note 1)	-0.5 V to 4 V
Output voltage range, V_O (all terminals)	-0.5 V to $V_{CC} + 0.5$ V
Input voltage range, V_I (all terminals)	-0.5 V to 5.5 V
Continuous total power dissipation	See Dissipation Rating Table
Storage temperature range, T_{stg}	-65°C to 150°C
Lead temperature 1,6 mm (1/16 inch) from case for 10 seconds	260°C

† Stresses beyond those listed under “absolute maximum ratings” may cause permanent damage to the device. These are stress ratings only, and functional operation of the device at these or any other conditions beyond those indicated under “recommended operating conditions” is not implied. Exposure to absolute-maximum-rated conditions for extended periods may affect device reliability.

NOTE 1: All voltage values are with respect to the GND terminals.

DISSIPATION RATING TABLE

PACKAGE	$T_A \leq 25^\circ\text{C}$ POWER RATING	DERATING FACTOR‡ ABOVE $T_A = 25^\circ\text{C}$	$T_A = 70^\circ\text{C}$ POWER RATING
DGG	1377 mW	11.0 mW/°C	822 mW

‡ This is the inverse of the junction-to-ambient thermal resistance when board mounted and with no air flow.

recommended operating conditions

	MIN	NOM	MAX	UNIT
Supply voltage, V_{CC}	3	3.3	3.6	V
High-level input voltage, V_{IH}	2			V
Low-level input voltage, V_{IL}			0.8	V
Differential load impedance, Z_L	90		132	Ω
Operating free-air temperature, T_A	0		70	°C

timing requirements

	MIN	NOM	MAX	UNIT
t_c Cycle time, input clock	14.7		32.3	ns
t_w Pulse duration, high-level input clock	$0.4 t_c$		$0.6 t_c$	ns
t_t Transition time, input signal			5	ns
t_{su} Setup time, data, D0 – D27 valid before $CLKIN\uparrow$ or $CLKIN\downarrow$ (see Figure 2)	3			ns
t_h Hold time, data, D0 – D27 valid after $CLKIN\uparrow$ or $CLKIN\downarrow$ (see Figure 2)	1.5			ns



electrical characteristics over recommended operating conditions (unless otherwise noted)

PARAMETER		TEST CONDITIONS	MIN	TYP†	MAX	UNIT
V_{IT}	Input threshold voltage			1.4		V
$ V_{OD} $	Differential steady-state output voltage magnitude	$R_L = 100 \Omega$, See Figure 3	247		454	mV
$\Delta V_{OD} $	Change in the steady-state differential output voltage magnitude between opposite binary states				50	mV
$V_{OC(SS)}$	Steady-state common-mode output voltage	See Figure 3	1.125		1.375	V
$V_{OC(PP)}$	Peak-to-peak common-mode output voltage				150	mV
I_{IH}	High-level input current	$V_{IH} = V_{CC}$			25	μA
I_{IL}	Low-level input current	$V_{IL} = 0$			± 10	μA
I_{OS}	Short-circuit output current	$V_O(Y_n) = 0$			± 24	mA
		$V_{OD} = 0$			± 12	mA
I_{OZ}	High-impedance state output current	$V_O = 0$ to V_{CC}			± 10	μA
I_{CC}	Quiescent supply current	Disabled, All inputs at GND			280	μA
		Enabled, $R_L = 100 \Omega$, Gray-scale pattern (see Figure 4), $V_{CC} = 3.3 V$, $t_c = 15.38 ns$		72	90	mA
		Enabled, $R_L = 100 \Omega$, Worst-case pattern (see Figure 5), $t_c = 15.38 ns$		85	110	mA
C_I	Input capacitance			3		pF

† All typical values are at $V_{CC} = 3.3 V$, $T_A = 25^\circ C$.

SN75LVDS83 FlatLink™ TRANSMITTER

SLLS2711 – MARCH 1997 – REVISED MAY 2009

switching characteristics over recommended operating conditions (unless otherwise noted)

PARAMETER	TEST CONDITIONS	MIN	TYP†	MAX	UNIT
t _{d0} Delay time, CLKOUT↑ to serial bit position 0	t _C = 15.38 ns (± 0.2%), Input clock jitter < 50 ps‡, See Figure 6	-0.2	0	0.2	ns
t _{d1} Delay time, CLKOUT↑ to serial bit position 1		$\frac{1}{7}t_C - 0.2$		$\frac{1}{7}t_C + 0.2$	ns
t _{d2} Delay time, CLKOUT↑ to serial bit position 2		$\frac{2}{7}t_C - 0.2$		$\frac{2}{7}t_C + 0.2$	ns
t _{d3} Delay time, CLKOUT↑ to serial bit position 3		$\frac{3}{7}t_C - 0.2$		$\frac{3}{7}t_C + 0.2$	ns
t _{d4} Delay time, CLKOUT↑ to serial bit position 4		$\frac{4}{7}t_C - 0.2$		$\frac{4}{7}t_C + 0.2$	ns
t _{d5} Delay time, CLKOUT↑ to serial bit position 5		$\frac{5}{7}t_C - 0.2$		$\frac{5}{7}t_C + 0.2$	ns
t _{d6} Delay time, CLKOUT↑ to serial bit position 6		$\frac{6}{7}t_C - 0.2$		$\frac{6}{7}t_C + 0.2$	ns
t _{sk(o)} Output skew, t _n - $\frac{n}{7}t_C$		-0.2		0.2	ns
t _{d7} Delay time, CLKIN↓ to CLKOUT↑	t _C = 18.51 ns (± 0.2%), Input clock jitter < 50 ps‡, See Figure 6	3.75	5.6	7.75	ns
Δt _{C(o)} Cycle time, output clock jitter§	t _C = 15.38 ± 0.75 sin(2π500E3t) + 0.05 ns, See Figure 7		±70		ps
	t _C = 15.38 ± 0.75 sin(2π3E6t) + 0.05 ns, See Figure 7		±187		ps
t _w Pulse duration, high-level output clock			$\frac{4}{7}t_C$		ns
t _t Transition time, differential output (t _r or t _f)	See Figure 3	260	700	1500	ps
t _{en} Enable time, SHTDN↑ to phase lock (Y _n valid)	See Figure 8		1		ms
t _{dis} Disable time, SHTDN↓ to off state (CLKOUT low)	See Figure 9		250		ns

† All typical values are at V_{CC} = 3.3 V, T_A = 25°C.

‡ |Input clock jitter| is the magnitude of the change in the input clock period.

§ Output clock jitter is the change in the output clock period from one cycle to the next cycle observed over 15000 cycles.



PARAMETER MEASUREMENT INFORMATION

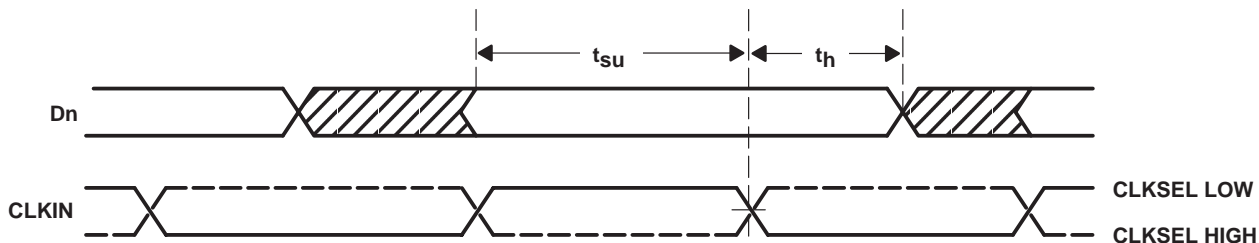

NOTE A: All input timing is defined at 1.4 V on an input signal with a 10%-to-90% rise or fall time of less than 5 ns.

Figure 2. Setup and Hold Time Waveforms

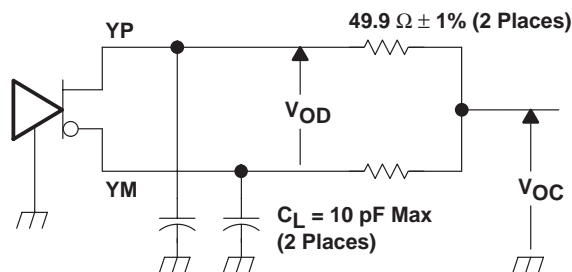

NOTE A: The lumped instrumentation capacitance for any single-ended voltage measurement is less than or equal to 10 pF. When making measurements at YP or YM, the complementary output is similarly loaded.

(a) SCHEMATIC

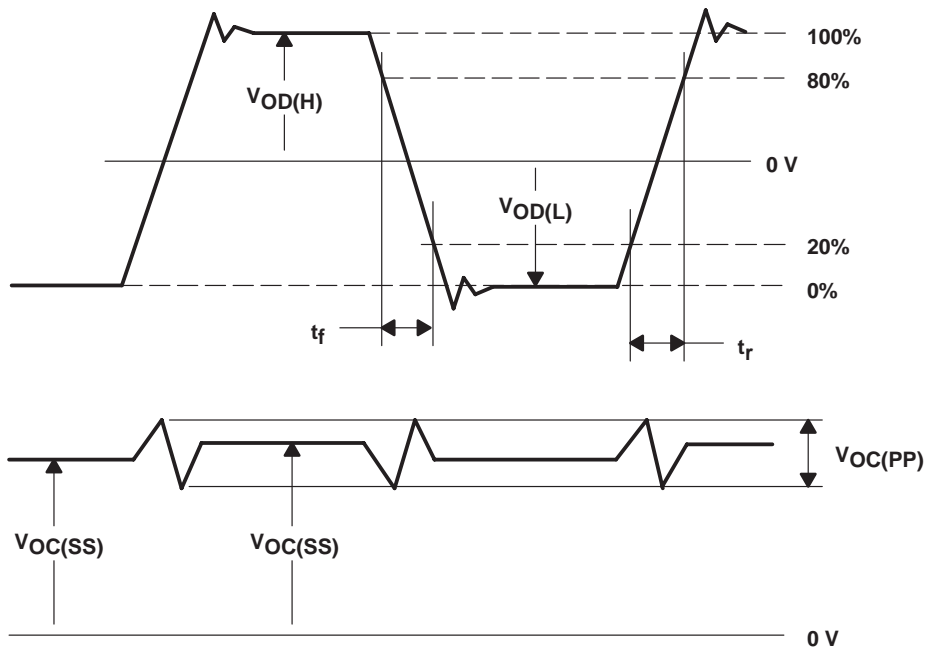

(b) WAVEFORMS

Figure 3. Test Load and Voltage Waveforms for LVDS Outputs

PARAMETER MEASUREMENT INFORMATION

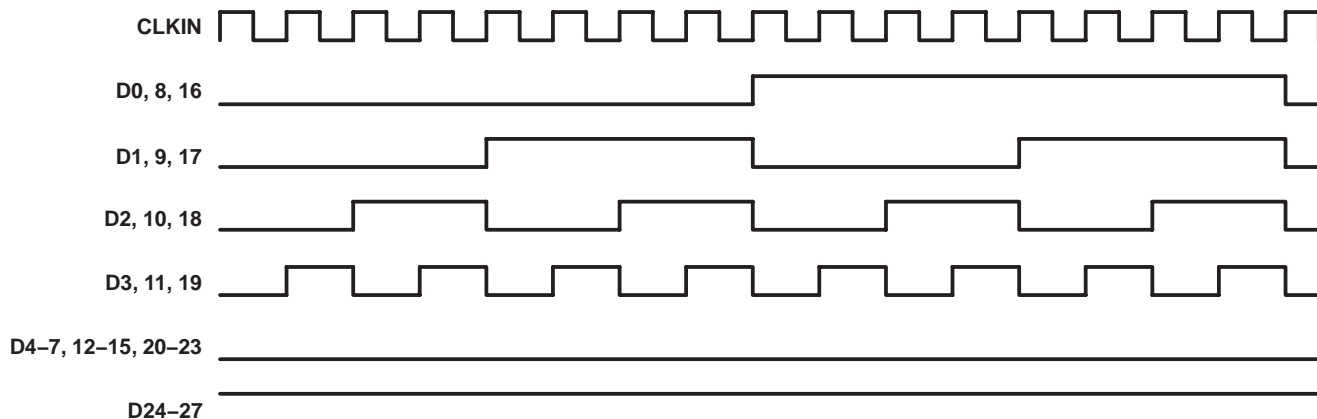

NOTE A: The 16-grayscale test-pattern test device power consumption for a typical display pattern. Pattern with CLKSEL low shown.

Figure 4. 16-Grayscale Test-Pattern Waveforms

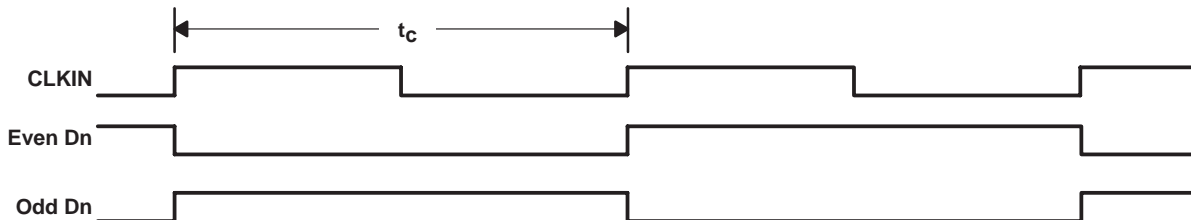

NOTE A: The worst-case test pattern produces nearly the maximum switching frequency for all of the LVDS outputs. Pattern with CLKSEL low shown.

Figure 5. Worst-Case Test-Pattern Waveforms

PARAMETER MEASUREMENT INFORMATION

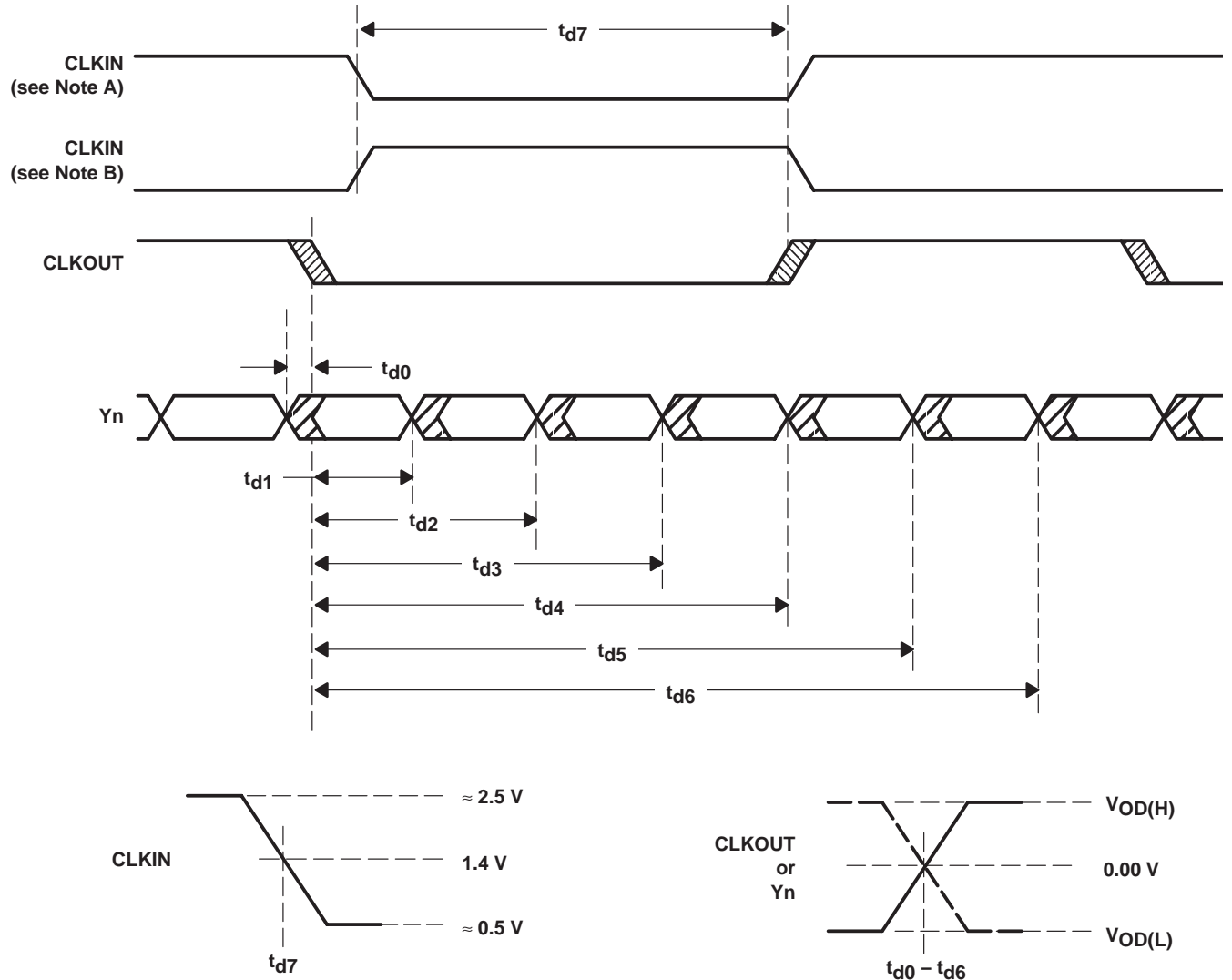

- NOTES: A. This wave form is valid when CLKSEL is low.
B. This wave form is valid when CLKSEL is high.

Figure 6. SN75LVDS83 Timing Waveforms

PARAMETER MEASUREMENT INFORMATION

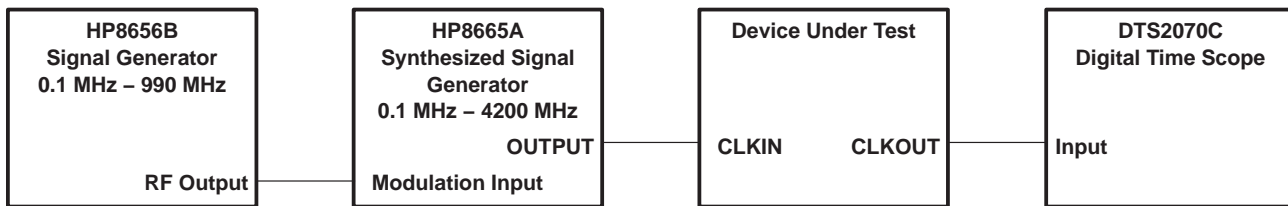
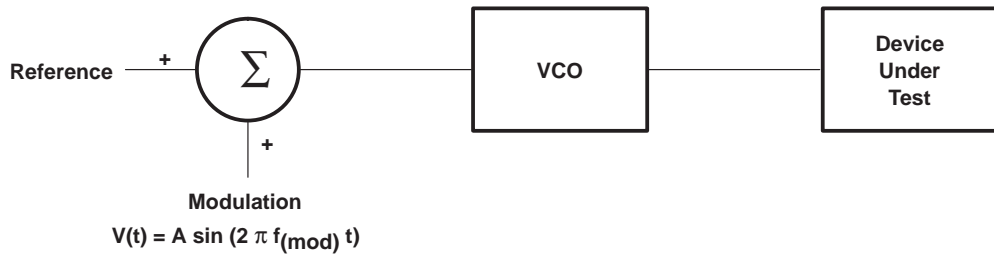

Figure 7. Output Clock Jitter Testing

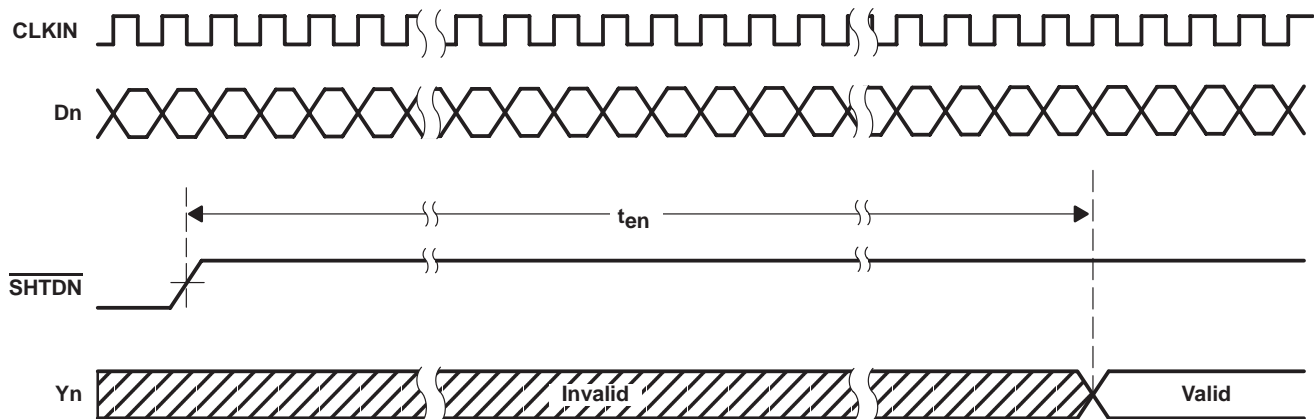

Figure 8. Enable Time Waveforms

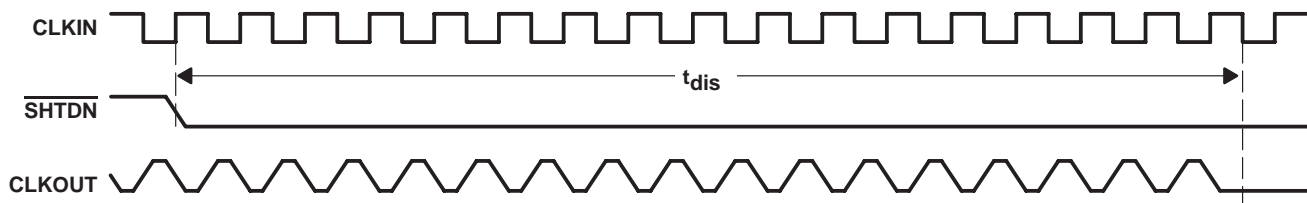

Figure 9. Disable Time Waveforms

TYPICAL CHARACTERISTICS

AVERAGE SUPPLY CURRENT
vs
CLOCK FREQUENCY

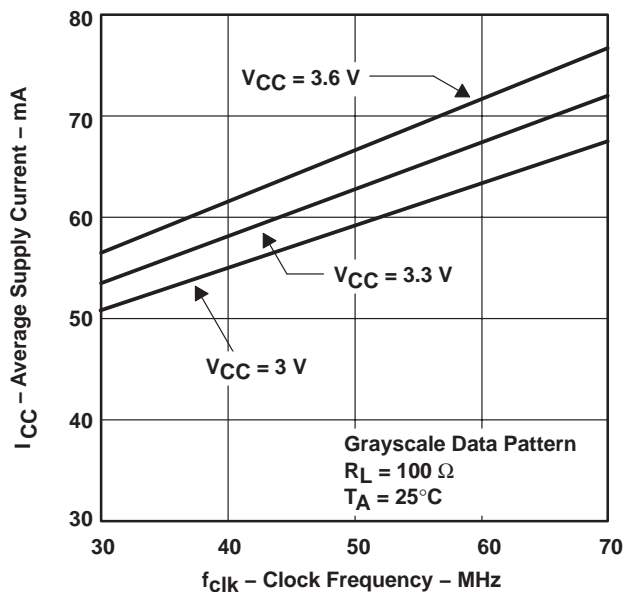

Figure 10

ZERO-TO-PEAK OUTPUT JITTER
vs
MODULATION FREQUENCY

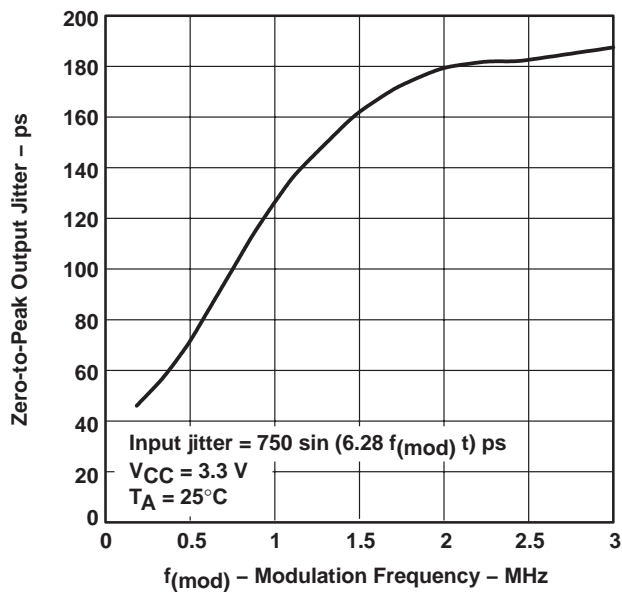
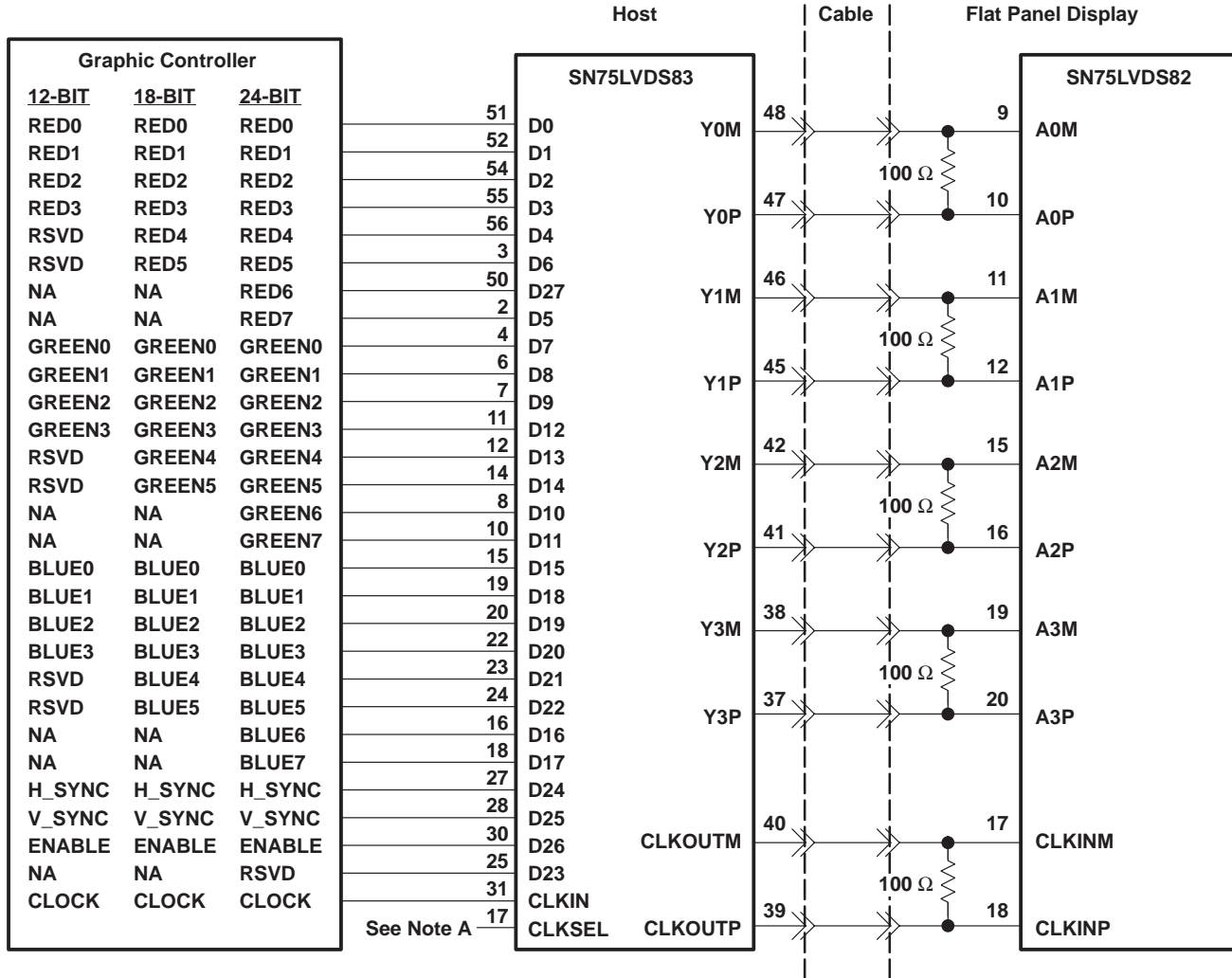

Figure 11

APPLICATION INFORMATION



NOTES: A. Connect this terminal to V_{CC} for triggering to the rising edge of the input clock and to GND for the falling edge.
 B. The five 100-Ω terminating resistors are recommended to be 0603 types.

Figure 12. 24-Bit Color Host To 24-Bit LCD Panel Display Application

APPLICATION INFORMATION

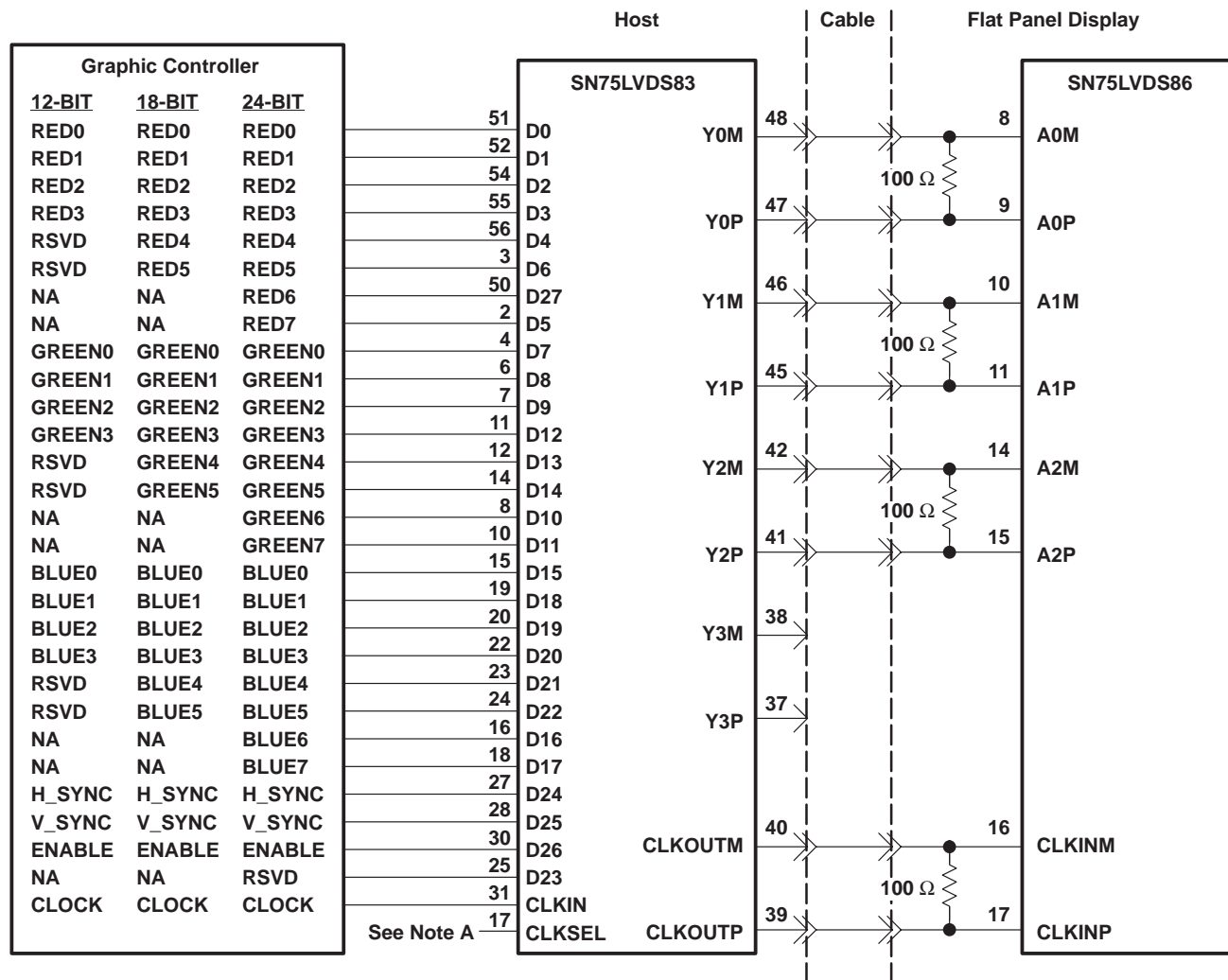

- NOTES: A. Connect this terminal to V_{CC} for triggering to the rising edge of the input clock and to GND for the falling edge.
 B. The four 100-Ω terminating resistors are recommended to be 0603 types.

Figure 13. 24-Bit Color Host To 18-Bit LCD Panel Display Application

PACKAGING INFORMATION

Orderable Device	Status ⁽¹⁾	Package Type	Package Drawing	Pins	Package Qty	Eco Plan ⁽²⁾	Lead/Ball Finish	MSL Peak Temp ⁽³⁾
SN75LVDS83DGG	ACTIVE	TSSOP	DGG	56	35	Green (RoHS & no Sb/Br)	CU NIPDAU	Level-2-260C-1 YEAR
SN75LVDS83DGGG4	ACTIVE	TSSOP	DGG	56	35	Green (RoHS & no Sb/Br)	CU NIPDAU	Level-2-260C-1 YEAR
SN75LVDS83DGGR	ACTIVE	TSSOP	DGG	56	2000	Green (RoHS & no Sb/Br)	CU NIPDAU	Level-2-260C-1 YEAR
SN75LVDS83DGGRG4	ACTIVE	TSSOP	DGG	56	2000	Green (RoHS & no Sb/Br)	CU NIPDAU	Level-2-260C-1 YEAR

⁽¹⁾ The marketing status values are defined as follows:

ACTIVE: Product device recommended for new designs.

LIFEBUY: TI has announced that the device will be discontinued, and a lifetime-buy period is in effect.

NRND: Not recommended for new designs. Device is in production to support existing customers, but TI does not recommend using this part in a new design.

PREVIEW: Device has been announced but is not in production. Samples may or may not be available.

OBSOLETE: TI has discontinued the production of the device.

⁽²⁾ Eco Plan - The planned eco-friendly classification: Pb-Free (RoHS), Pb-Free (RoHS Exempt), or Green (RoHS & no Sb/Br) - please check <http://www.ti.com/productcontent> for the latest availability information and additional product content details.

TBD: The Pb-Free/Green conversion plan has not been defined.

Pb-Free (RoHS): TI's terms "Lead-Free" or "Pb-Free" mean semiconductor products that are compatible with the current RoHS requirements for all 6 substances, including the requirement that lead not exceed 0.1% by weight in homogeneous materials. Where designed to be soldered at high temperatures, TI Pb-Free products are suitable for use in specified lead-free processes.

Pb-Free (RoHS Exempt): This component has a RoHS exemption for either 1) lead-based flip-chip solder bumps used between the die and package, or 2) lead-based die adhesive used between the die and leadframe. The component is otherwise considered Pb-Free (RoHS compatible) as defined above.

Green (RoHS & no Sb/Br): TI defines "Green" to mean Pb-Free (RoHS compatible), and free of Bromine (Br) and Antimony (Sb) based flame retardants (Br or Sb do not exceed 0.1% by weight in homogeneous material)

⁽³⁾ MSL, Peak Temp. -- The Moisture Sensitivity Level rating according to the JEDEC industry standard classifications, and peak solder temperature.

Important Information and Disclaimer: The information provided on this page represents TI's knowledge and belief as of the date that it is provided. TI bases its knowledge and belief on information provided by third parties, and makes no representation or warranty as to the accuracy of such information. Efforts are underway to better integrate information from third parties. TI has taken and continues to take reasonable steps to provide representative and accurate information but may not have conducted destructive testing or chemical analysis on incoming materials and chemicals. TI and TI suppliers consider certain information to be proprietary, and thus CAS numbers and other limited information may not be available for release.

In no event shall TI's liability arising out of such information exceed the total purchase price of the TI part(s) at issue in this document sold by TI to Customer on an annual basis.

TAPE AND REEL INFORMATION



QUADRANT ASSIGNMENTS FOR PIN 1 ORIENTATION IN TAPE



*All dimensions are nominal

Device	Package Type	Package Drawing	Pins	SPQ	Reel Diameter (mm)	Reel Width W1 (mm)	A0 (mm)	B0 (mm)	K0 (mm)	P1 (mm)	W (mm)	Pin1 Quadrant
SN75LVDS83DGGR	TSSOP	DGG	56	2000	330.0	24.4	8.6	15.6	1.8	12.0	24.0	Q1

TAPE AND REEL BOX DIMENSIONS



*All dimensions are nominal

Device	Package Type	Package Drawing	Pins	SPQ	Length (mm)	Width (mm)	Height (mm)
SN75LVDS83DGGR	TSSOP	DGG	56	2000	346.0	346.0	41.0

DGG (R-PDSO-G**)

PLASTIC SMALL-OUTLINE PACKAGE

48 PINS SHOWN



- NOTES: A. All linear dimensions are in millimeters.
 B. This drawing is subject to change without notice.
 C. Body dimensions do not include mold protrusion not to exceed 0,15.
 D. Falls within JEDEC MO-153

IMPORTANT NOTICE

Texas Instruments Incorporated and its subsidiaries (TI) reserve the right to make corrections, modifications, enhancements, improvements, and other changes to its products and services at any time and to discontinue any product or service without notice. Customers should obtain the latest relevant information before placing orders and should verify that such information is current and complete. All products are sold subject to TI's terms and conditions of sale supplied at the time of order acknowledgment.

TI warrants performance of its hardware products to the specifications applicable at the time of sale in accordance with TI's standard warranty. Testing and other quality control techniques are used to the extent TI deems necessary to support this warranty. Except where mandated by government requirements, testing of all parameters of each product is not necessarily performed.

TI assumes no liability for applications assistance or customer product design. Customers are responsible for their products and applications using TI components. To minimize the risks associated with customer products and applications, customers should provide adequate design and operating safeguards.

TI does not warrant or represent that any license, either express or implied, is granted under any TI patent right, copyright, mask work right, or other TI intellectual property right relating to any combination, machine, or process in which TI products or services are used. Information published by TI regarding third-party products or services does not constitute a license from TI to use such products or services or a warranty or endorsement thereof. Use of such information may require a license from a third party under the patents or other intellectual property of the third party, or a license from TI under the patents or other intellectual property of TI.

Reproduction of TI information in TI data books or data sheets is permissible only if reproduction is without alteration and is accompanied by all associated warranties, conditions, limitations, and notices. Reproduction of this information with alteration is an unfair and deceptive business practice. TI is not responsible or liable for such altered documentation. Information of third parties may be subject to additional restrictions.

Resale of TI products or services with statements different from or beyond the parameters stated by TI for that product or service voids all express and any implied warranties for the associated TI product or service and is an unfair and deceptive business practice. TI is not responsible or liable for any such statements.

TI products are not authorized for use in safety-critical applications (such as life support) where a failure of the TI product would reasonably be expected to cause severe personal injury or death, unless officers of the parties have executed an agreement specifically governing such use. Buyers represent that they have all necessary expertise in the safety and regulatory ramifications of their applications, and acknowledge and agree that they are solely responsible for all legal, regulatory and safety-related requirements concerning their products and any use of TI products in such safety-critical applications, notwithstanding any applications-related information or support that may be provided by TI. Further, Buyers must fully indemnify TI and its representatives against any damages arising out of the use of TI products in such safety-critical applications.

TI products are neither designed nor intended for use in military/aerospace applications or environments unless the TI products are specifically designated by TI as military-grade or "enhanced plastic." Only products designated by TI as military-grade meet military specifications. Buyers acknowledge and agree that any such use of TI products which TI has not designated as military-grade is solely at the Buyer's risk, and that they are solely responsible for compliance with all legal and regulatory requirements in connection with such use.

TI products are neither designed nor intended for use in automotive applications or environments unless the specific TI products are designated by TI as compliant with ISO/TS 16949 requirements. Buyers acknowledge and agree that, if they use any non-designated products in automotive applications, TI will not be responsible for any failure to meet such requirements.

Following are URLs where you can obtain information on other Texas Instruments products and application solutions:

Products

Amplifiers	amplifier.ti.com
Data Converters	dataconverter.ti.com
DLP® Products	www.dlp.com
DSP	dsp.ti.com
Clocks and Timers	www.ti.com/clocks
Interface	interface.ti.com
Logic	logic.ti.com
Power Mgmt	power.ti.com
Microcontrollers	microcontroller.ti.com
RFID	www.ti-rfid.com
RF/IF and ZigBee® Solutions	www.ti.com/lprf

Applications

Audio	www.ti.com/audio
Automotive	www.ti.com/automotive
Broadband	www.ti.com/broadband
Digital Control	www.ti.com/digitalcontrol
Medical	www.ti.com/medical
Military	www.ti.com/military
Optical Networking	www.ti.com/opticalnetwork
Security	www.ti.com/security
Telephony	www.ti.com/telephony
Video & Imaging	www.ti.com/video
Wireless	www.ti.com/wireless

Mailing Address: Texas Instruments, Post Office Box 655303, Dallas, Texas 75265
Copyright © 2009, Texas Instruments Incorporated