

SP 8720 A, B & M

UHF PROGRAMMABLE DIVIDER 300 MHz \pm 3/4

The SP8720 A, B & M are high speed programmable \pm 3/4 counters operating at an input frequency of up to 300MHz over the temperature ranges -55°C to $+125^{\circ}\text{C}$, 0°C to $+70^{\circ}\text{C}$ and -40°C to $+85^{\circ}\text{C}$ respectively.

The clock input is biased internally and is coupled to the signal source by a capacitor. The input signal path is completed by an input reference decoupling capacitor which is connected to earth.

The division ratio is controlled by two $\overline{\text{PE}}$ inputs. The counter will divide by 3 when either input is in the high state, and by 4 when both inputs are in the low state. These inputs are compatible with standard ECL 10K inputs and have the same temperature characteristics. Both inputs have nominal $4.3\text{k}\Omega$ internal pulldown resistors.

The true and inverse outputs are compatible with standard ECL 11 outputs. They may be used to drive ECL 10K circuits by the inclusion of two resistors as shown in Fig. 4.

When using the device as a divide-by-three prescaler the inverse output ($\overline{\text{Q}}_2$) should be connected to a $\overline{\text{PE}}$ input.

FEATURES

- Full temperature range operation :
 - 'A' Grade -55°C to $+125^{\circ}\text{C}$
 - 'B' Grade 0°C to $+70^{\circ}\text{C}$
 - 'M' Grade -40°C to $+85^{\circ}\text{C}$
- Self Biasing CP Input
- Wide Input Dynamic Range
- Control Inputs ECL 10K - Compatible
- Low Propagation Delay
- True and Inverse Outputs Available

ABSOLUTE MAXIMUM RATINGS

Power supply voltage $|V_{CC} - V_{EE}|$ 0V to $+8\text{V}$
 Input voltage, $\overline{\text{PE}}$ inputs 0V to V_{CC}
 Input voltage, CP input 2V peak-to-peak
 Output current 20mA
 Operating junction temperature $+150^{\circ}\text{C}$
 Storage temperature -55°C to $+150^{\circ}\text{C}$

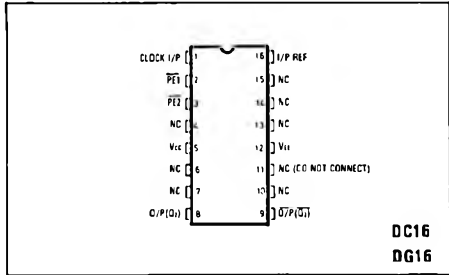

Fig. 1 Pin connections (top view)

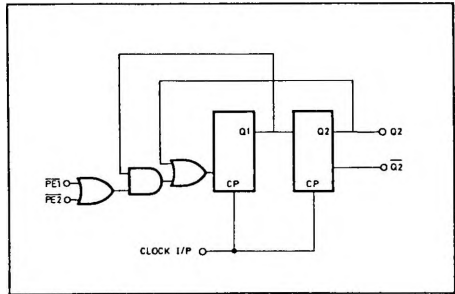

Fig. 2 Logic diagram SP8720

Clock Pulse	Q ₁	Q ₂
1	L	H
2	L	L
3	H	L
4	H	H

← Extra State

Table 1 Count sequence

$\overline{\text{PE}}_1$	$\overline{\text{PE}}_2$	Div Ratio.
L	L	4
H	L	3
L	H	3
H	H	3

Table 2 Truth table for control inputs

ELECTRICAL CHARACTERISTICS

PE inputs - ECL 10K compatible
 Outputs - ECL II compatible

Test conditions (unless otherwise stated)

Tamb 'A' Grade: -55°C to +125°C
 'B' Grade: 0°C to +70°C
 'M' Grade: -40°C to +85°C

Supply voltages: $V_{CC} = +5.2V \pm 0.25V$
 $V_{EE} = 0V$

Clock input voltage: 400mV to 800mV (p-p)

Characteristic	Value			Units	Conditions
	Min.	Typ.	Max.		
Max. i/p frequency	300			MHz	$V_{CC} = +5.2V$ Sinewave Input
Min.i/p frequency			40		
Min. slew rate for square wave input			100	V/ μ s	
Propagation delay (clock i/p to device o/p)		4		ns	$V_{CC} = +5.2V, 25^\circ C$ $V_{CC} = +5.2V, 25^\circ C$
PE input reference level		+ 3.9		V	
Power supply drain current		40	55	mA	
PE input pull down resistors		4.3		k Ω	
Clock i/p impedance (i/p to i/p ref. low frequency)		400		Ω	

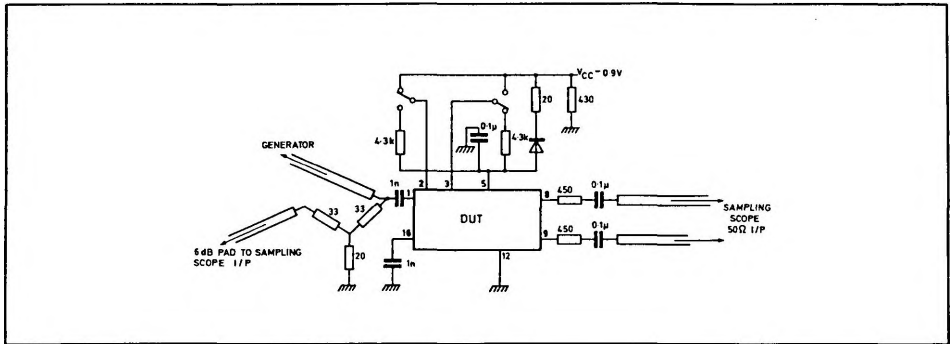

Fig. 3 Test circuit

APPLICATION NOTES

When operating the SP8720 in a synthesiser loop at 300MHz, the delay time through the programmable divider controlling the SP8720 is approximately 5.5ns, and will require ECL.

The simple passive interface from the output of the SP8720 into ECL 10K logic is defined in Fig. 4.

If TTL is required, the input interface to the PE pins, and the output of the SP8720 into TTL, is shown in Fig.5.

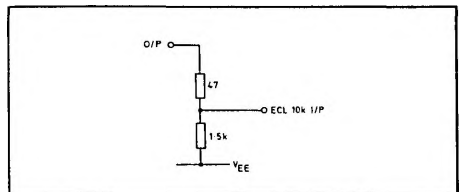

Fig. 4

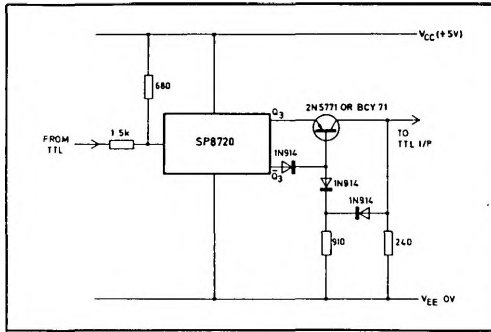

Fig. 5

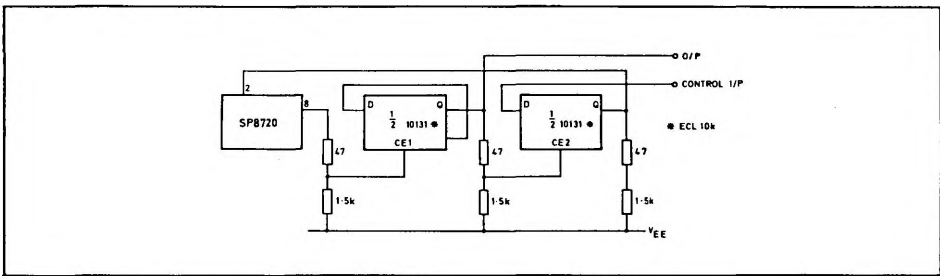
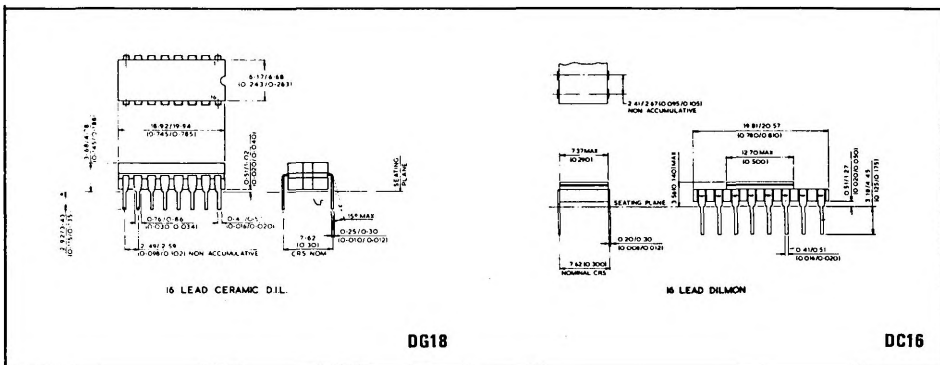

Fig. 6 Divide by 6/8 Control loop delay time approximately 20ns at 300MHz I/P frequency

PACKAGE DETAILS

Dimensions are shown thus: mm(in)



DG18

DC16