

SP 8746 A, B & M

DC COUPLED UHF PROGRAMMABLE DIVIDER 300 MHz \div 6/7

In frequency synthesis it is desirable to start programmable division at as high a frequency as possible, because this raises the comparison frequency and so improves the overall synthesiser performance.

The SP8746 series are UHF integrated circuits that can be logically programmed to divide by either 6 or 7, with input frequencies up to 300 MHz. The design of very fast fully programmable dividers is therefore greatly simplified by the use of these devices and makes them particularly useful in frequency synthesisers operating in the UHF band.

All inputs and outputs are ECL-compatible throughout the temperature range: the clock inputs and programming inputs are ECL III-compatible while the two complementary outputs are ECL II-compatible to reduce power consumption in the output stage. ECL III output compatibility can be achieved very simply, however (see Operating Notes).

The division ratio is controlled by two \overline{PE} inputs. The counter will divide by 6 when either \overline{PE} input is in the high state and by 7 when both inputs are in the low state. Both the \overline{PE} inputs and the clock inputs have nominal 4.3k Ω pulldown resistors to V_{EE} (negative rail).

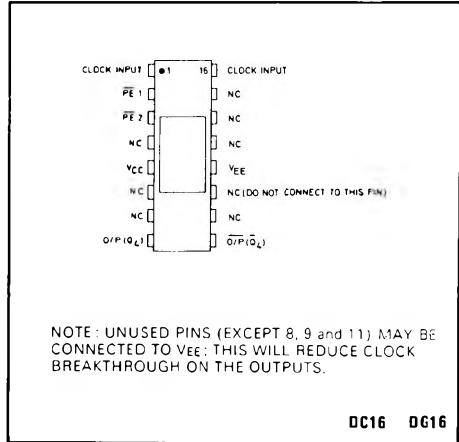

Fig. 1 Pin connections (top)

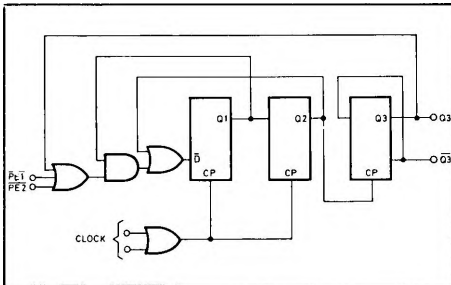

Fig. 2 Logic diagram (positive logic)

ABSOLUTE MAXIMUM RATINGS

Supply voltage $ V_{CC} - V_{EE} $	8V
Input voltage V_{in} (d.c.)	Not greater than the supply voltage in use.
Output current I_{out}	20mA
Max. junction temperature	+150°C
Storage temperature range	-55°C to +175°C

FEATURES

- Military and Industrial Variants.
- 300 MHz Toggle Frequency.
- Low Power Consumption
- ECL Compatibility on All I/Ps & O/Ps
- Low Propagation Delay
- True and Inverse Outputs

QUICK REFERENCE DATA

- Temperature Ranges:
 - 'A' Grade -55°C to +125°C
 - 'B' Grade 0°C to +70°C
 - 'M' Grade -40°C to +85°C
- Supply Voltage
 - $|V_{CC} - V_{EE}|$ 5.2V
- Power Consumption 250mW Typ.
- Propagation Delay 3ns Typ.

Clock Pulse	Q ₂	Q ₃	Q ₄
1	L	H	H
2	L	L	H
3	H	L	H
4	L	H	L
5	L	L	L
6	H	L	L
7	H	H	H

Extra state
 Table 1 Count sequence

\overline{PE}_1	\overline{PE}_2	Div Ratio
L	L	7
H	L	6
L	H	6
H	H	6

Table 2 Truth table for control inputs

ELECTRICAL CHARACTERISTICS

Test conditions (unless otherwise stated):

- T_{amb}: 'A' grade -55°C to +125°C
- 'B' grade 0°C to +70°C
- 'M' grade -40°C to +85°C
- Supply voltage (see note 1): V_{CC} 0V
- V_{EE} -5.2V

The maximum possible loop delay for control is obtained if the L → H transition from Q₃ or the H → L transition from \overline{Q}_3 is used to clock the stage controlling the ÷6/7. The loop delay is 6 clock periods minus the internal delays of the ÷6/7 circuit.

Static Characteristics

Characteristic	Value			Units	Conditions
	Min.	Typ.	Max.		
Clock and \overline{PE} input voltage levels	-1.10		-0.81	V	T _{amb} = +25°C, see Note 2
V _{INH} V _{INL}	-1.85		-1.50	V	
Input pulldown resistance, between pins 1, 2, 3, and 16 and V _{EE} (pin 12)		4.3		KΩ	T _{amb} = +25°C, see Note 3. I _{out} (external) = 0mA (There is an internal circuit equivalent to a 2kΩ pulldown resistor on each output)
Output voltage levels	-0.85		-1.50	V	
V _{OH} V _{OL}				V	
Power supply drain current		50	65	mA	

NOTES

1. The devices are specified for operation with the power supplies of V_{CC} = 0V and V_{EE} = -5.2V ± 0.25V, which are the normal ECL supply rails. They will also operate satisfactorily with TTL rails of V_{CC} = +5V ± 0.25V and V_{EE} = 0V.
2. The input reference voltage has the same temperature coefficient as ECL III and ECL 10K.
3. The output voltage levels have the same temperature coefficients as ECL II output levels.

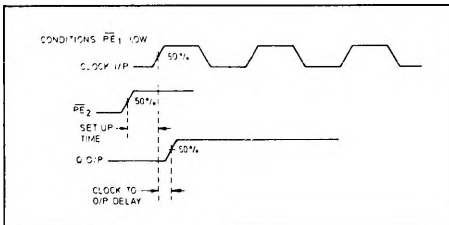

Fig. 3 Set-up timing diagram

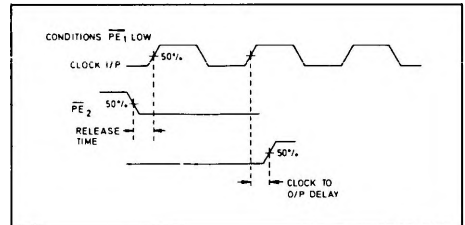

Fig. 4 Release timing diagram

Dynamic Characteristics

Characteristic	Type	Value			Units	Conditions
		Min.	Typ.	Max.		
Clock input voltage levels						
V_{INH}	All	-1.10		-0.90	V	$T_{amb} = +25^{\circ}C$, see Note 4
V_{INL}	All	-1.70		-1.50	V	
Max. toggle frequency	All	300			MHz MHz MHz MHz	
Min. frequency with sinewave clock input				10	MHz	
Min. slew rate of square wave input for correct operation down to 0MHz				20	V/ μ s	
Propagation delay (clock input to device output)			3		ns	
Set-up time			1.5		ns	See note 5
Release time			1.5		ns	See note 6

NOTES

- The devices are dynamically tested using the circuit shown in Fig.5. The bias chain has the same temperature coefficient as ECL III and ECL 10K, and therefore tracks the input reference throughout the temperature range. The devices are tested with input amplitudes of 400 and 800 mV p-p about that reference, over the full temperature range.
- Set-up time is defined as the minimum time that can elapse between a L→H transition of a control input and the next L→H clock pulse to ensure that the $\bar{\phi}6$ mode is forced by that clock pulse (see Fig. 3).
- Release time is defined as the minimum time that can elapse between a H→L transition of a control input and the next L→H clock pulse to ensure that the $\bar{\phi}7$ mode is forced by that clock pulse (see Fig. 4).

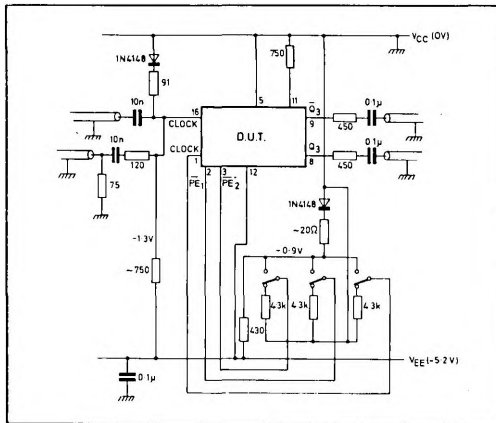

Fig. 5 Test circuit for dynamic measurements

SP8746

OPERATING NOTES

The SP8746 range of devices are designed to operate in the UHF band and therefore PCB layouts should comply with normal UHF rules, e.g. non-inductive resistors and capacitors should be used, power supply rails decoupled, etc.

All clock and control inputs are compatible with ECL III and ECL 10K throughout the temperature range. However, it is often desirable to capacitively-couple the signal source to the clock, in which case an external bias network is required as shown in Fig. 6. Alternatively an SP8741 can be substituted.

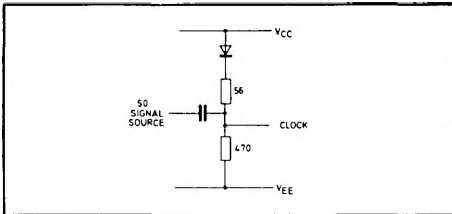

Fig. 6 Recommended input bias configuration for capacitive coupling to a continuous 50Ω signal source.

The $\div 6/7$ can be controlled by a TTL fully-programmable counter, provided that delays within the loop are kept to a minimum. The outputs and control inputs must therefore interface to TTL. The input TTL to ECL interface is accomplished with two resistors as shown in Fig. 7. The output ECL to TTL interface requires some gain and therefore uses a transistor. This interface as shown on Fig. 7, gives the true output; the inverse can be obtained by interchanging the Q_3 and \overline{Q}_3 outputs. The output interface will operate satisfactorily over the full military temperature range (-55°C to $+125^\circ\text{C}$) at frequencies in excess of 35MHz. It has a fan out of one and the propagation delay through the divider plus the interface and one Schottky TTL gate is approximately 10ns. At an input frequency of 300 MHz this would only I_{cavc} about 10 ns for the fully programmable counter to control the $\div 6/7$. The loop delay can be increased by extending the $\div 6/7$ function to, say, $\div 24/25$ or $48/49$ (see Application Notes)

The SP8746 device O/Ps are compatible with ECL II levels when there is no external load. They can be made compatible with ECL III and ECL 10K with a simple potential dividing network as shown in Fig. 8.

The control and clock inputs are already compatible with ECL III and ECL 10K. The interface circuit of Fig. 8 can also be used to increase noise immunity when interfacing from ECL III and ECL 10K outputs at low current levels to ECL III and ECL 10K inputs.

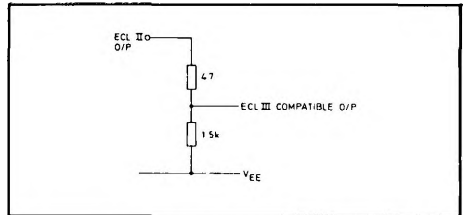

Fig. 8 ECL II to ECL III interface

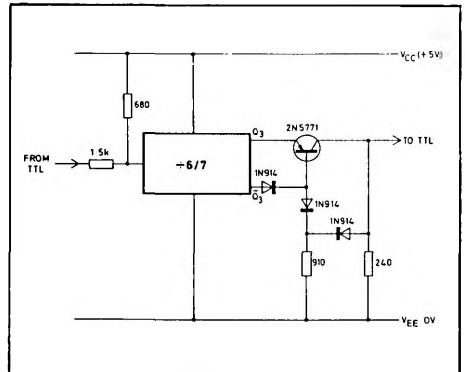

Fig. 7 TTL to ECL and ECL/TTL interfaces (for SP8746 devices and TTL operating from the same supply rails)