

FEATURES

- Avalanche Rugged Technology
- Rugged Gate Oxide Technology
- Lower Input Capacitance
- Improved Gate Charge
- Extended Safe Operating Area
- Lower Leakage Current : 25 μ A (Max.) @ $V_{DS} = 900V$
- Low $R_{DS(ON)}$: 4.181 Ω (Typ.)

$$BV_{DSS} = 900 V$$

$$R_{DS(on)} = 5.0 \Omega$$

$$I_D = 4 A$$

TO-220

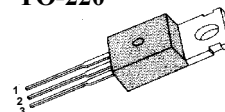

1.Gate 2. Drain 3. Source

Absolute Maximum Ratings

Symbol	Characteristic	Value	Units
V_{DSS}	Drain-to-Source Voltage	900	V
I_D	Continuous Drain Current ($T_C=25^\circ C$)	4	A
	Continuous Drain Current ($T_C=100^\circ C$)	2.5	
I_{DM}	Drain Current-Pulsed ①	16	A
V_{GS}	Gate-to-Source Voltage	± 30	V
E_{AS}	Single Pulsed Avalanche Energy ②	424	mJ
I_{AR}	Avalanche Current ①	4	A
E_{AR}	Repetitive Avalanche Energy ①	12	mJ
dv/dt	Peak Diode Recovery dv/dt ③	1.5	V/ns
P_D	Total Power Dissipation ($T_C=25^\circ C$)	120	W
	Linear Derating Factor	0.96	
T_J, T_{STG}	Operating Junction and Storage Temperature Range	- 55 to +150	$^\circ C$
T_L	Maximum Lead Temp. for Soldering Purposes, 1/8" from case for 5-seconds	300	

Thermal Resistance

Symbol	Characteristic	Typ.	Max.	Units
$R_{\theta JC}$	Junction-to-Case	--	1.04	$^\circ C / W$
$R_{\theta CS}$	Case-to-Sink	0.5	--	
$R_{\theta JA}$	Junction-to-Ambient	--	62.5	

Electrical Characteristics (T_C=25 °C unless otherwise specified)

Symbol	Characteristic	Min.	Typ.	Max.	Units	Test Condition
BV _{DSS}	Drain-Source Breakdown Voltage	900	--	--	V	V _{GS} =0V, I _D =250μA
ΔBV/ΔT _J	Breakdown Voltage Temp. Coeff.	--	1.14	--	V/°C	I _D =250μA See Fig 7
V _{GS(th)}	Gate Threshold Voltage	2.0	--	3.5	V	V _{DS} =5V, I _D =250μA
I _{GSS}	Gate-Source Leakage , Forward	--	--	100	nA	V _{GS} =30V
	Gate-Source Leakage , Reverse	--	--	-100		V _{GS} =-30V
I _{DSS}	Drain-to-Source Leakage Current	--	--	25	μA	V _{DS} =900V
		--	--	250		V _{DS} =720V, T _C =125 °C
R _{DS(on)}	Static Drain-Source On-State Resistance	--	--	5.0	Ω	V _{GS} =10V, I _D =2A ④*
g _{fs}	Forward Transconductance	--	2.85	--	Ū	V _{DS} =50V, I _D =2A ④
C _{iss}	Input Capacitance	--	730	950	pF	V _{GS} =0V, V _{DS} =25V, f =1MHz See Fig 5
C _{oss}	Output Capacitance	--	65	75		
C _{rss}	Reverse Transfer Capacitance	--	24	30		
t _{d(on)}	Turn-On Delay Time	--	18	45	ns	V _{DD} =450V, I _D =4A, R _G =13.6 Ω See Fig 13 ④ ⑤
t _r	Rise Time	--	29	70		
t _{d(off)}	Turn-Off Delay Time	--	51	110		
t _f	Fall Time	--	28	65		
Q _g	Total Gate Charge	--	35	46	nC	V _{DS} =720V, V _{GS} =10V, I _D =4A See Fig 6 & Fig 12 ④ ⑤
Q _{gs}	Gate-Source Charge	--	6.6	--		
Q _{gd}	Gate-Drain("Miller") Charge	--	15.0	--		

Source-Drain Diode Ratings and Characteristics

Symbol	Characteristic	Min.	Typ.	Max.	Units	Test Condition
I _S	Continuous Source Current	--	--	4	A	Integral reverse pn-diode in the MOSFET
I _{SM}	Pulsed-Source Current ①	--	--	16		
V _{SD}	Diode Forward Voltage ④	--	--	1.4	V	T _J =25 °C, I _S =4A, V _{GS} =0V
t _{rr}	Reverse Recovery Time	--	430	--	ns	T _J =25 °C, I _F =4A
Q _{rr}	Reverse Recovery Charge	--	2.9	--	μC	di _F /dt=100A/μs ④

Notes ;

- ① Repetitive Rating : Pulse Width Limited by Maximum Junction Temperature
- ② L=50mH, I_{AS}=4A, V_{DD}=50V, R_G=27Ω, Starting T_J=25 °C
- ③ I_{SD} ≤ 4A, di/dt ≤ 100A/μs, V_{DD} ≤ BV_{DSS}, Starting T_J=25 °C
- ④ Pulse Test : Pulse Width = 250μs, Duty Cycle ≤ 2%
- ⑤ Essentially Independent of Operating Temperature

Fig 1. Output Characteristics

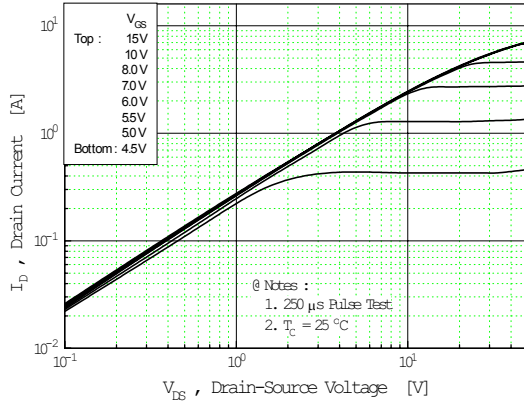

Fig 2. Transfer Characteristics

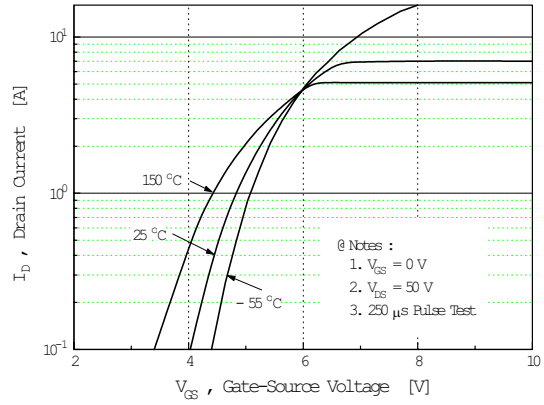

Fig 3. On-Resistance vs. Drain Current

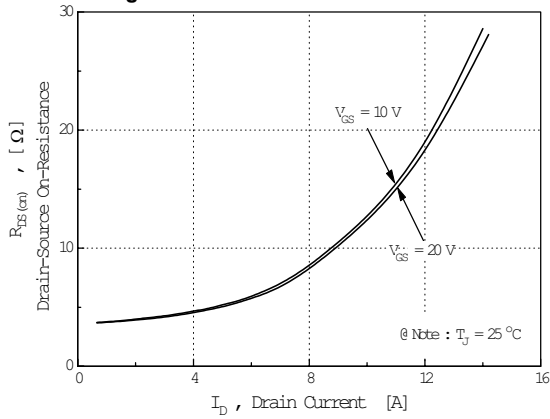

Fig 4. Source-Drain Diode Forward Voltage

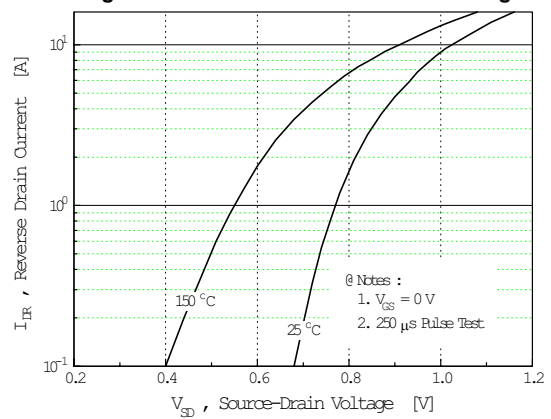

Fig 5. Capacitance vs. Drain-Source Voltage

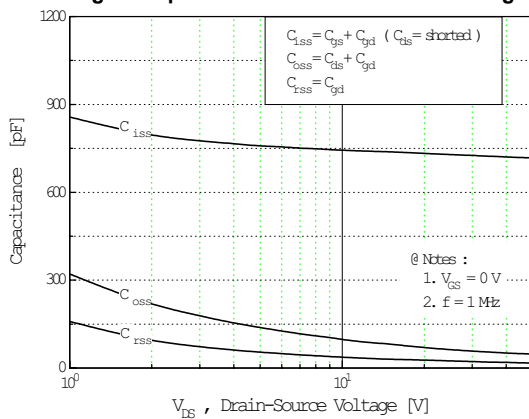
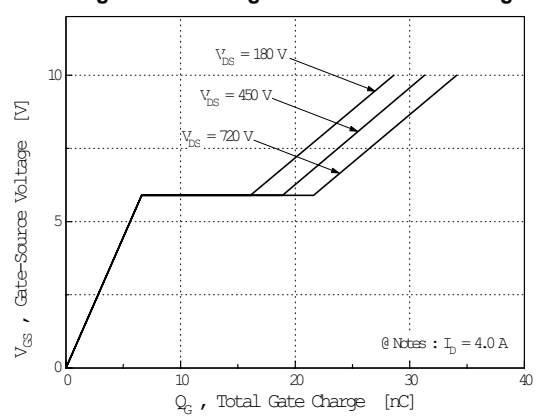

Fig 6. Gate Charge vs. Gate-Source Voltage



SSP4N90A

N-CHANNEL POWER MOSFET

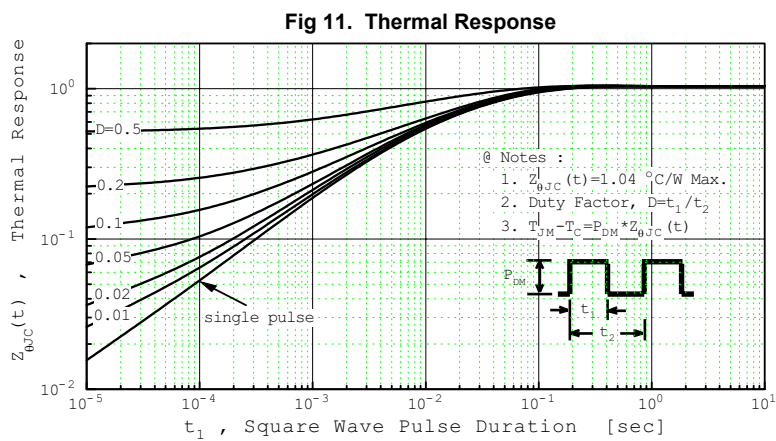
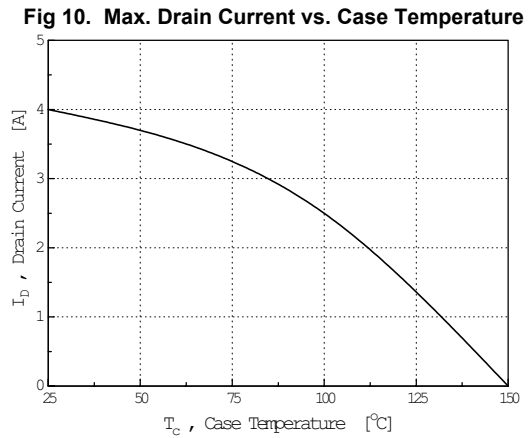
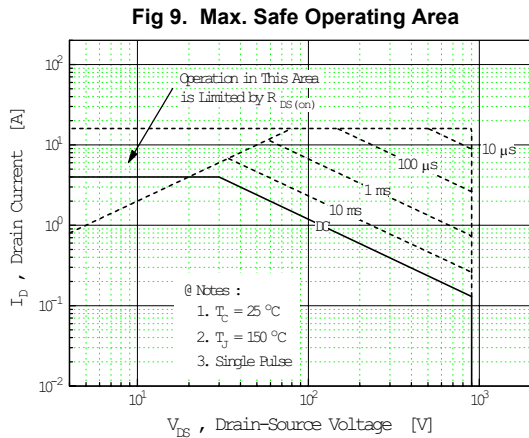
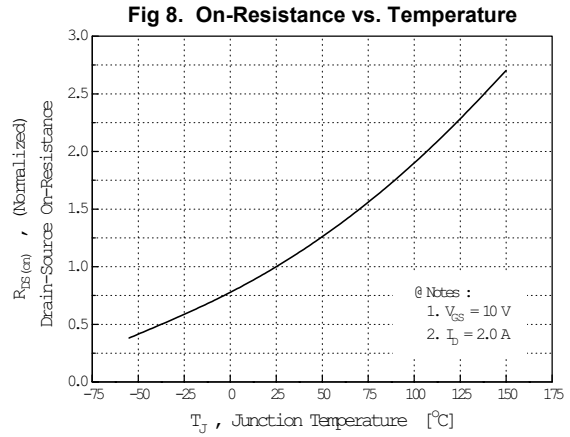
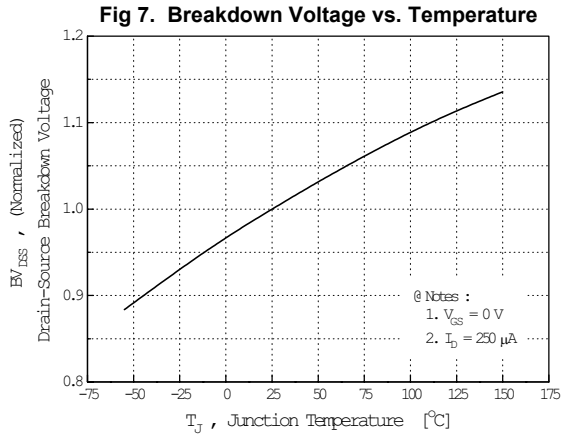

Fig 12. Gate Charge Test Circuit & Waveform

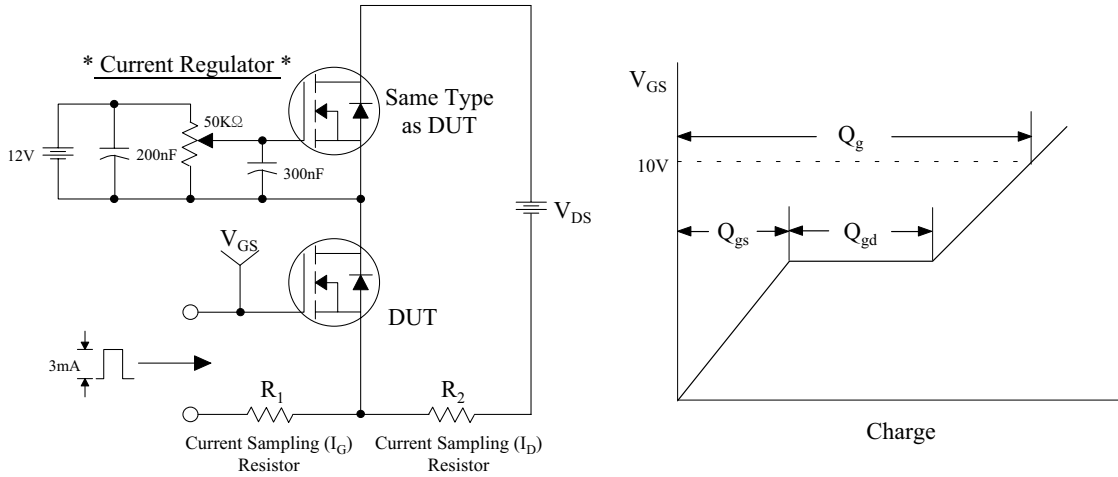

Fig 13. Resistive Switching Test Circuit & Waveforms

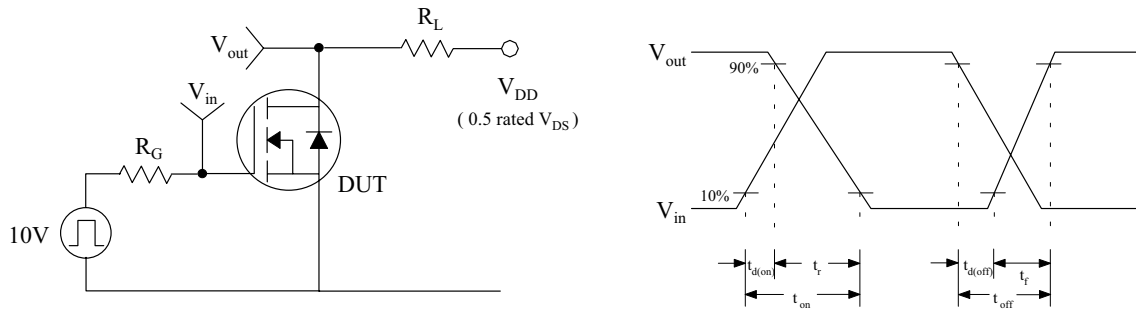

Fig 14. Unclamped Inductive Switching Test Circuit & Waveforms

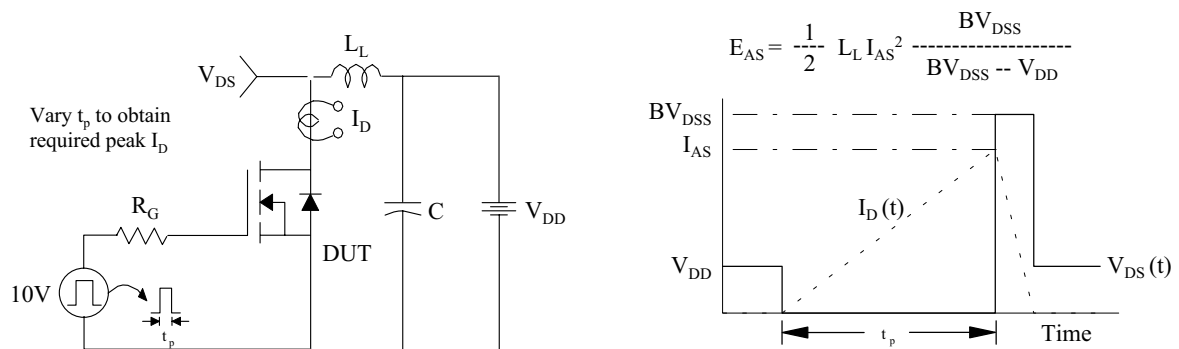

Fig 15. Peak Diode Recovery dv/dt Test Circuit & Waveforms

