

**FEATURES**

- Avalanche Rugged Technology
- Rugged Gate Oxide Technology
- Lower Input Capacitance
- Improved Gate Charge
- Extended Safe Operating Area
- Lower Leakage Current : 25  $\mu$ A (Max.) @  $V_{DS} = 600V$
- Lower  $R_{DS(ON)}$  : 0.977  $\Omega$  (Typ.)

$$BV_{DSS} = 600 V$$

$$R_{DS(on)} = 1.2 \Omega$$

$$I_D = 7 A$$

TO-220

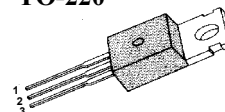

1.Gate 2. Drain 3. Source

**Absolute Maximum Ratings**

Symbol	Characteristic	Value	Units
$V_{DSS}$	Drain-to-Source Voltage	600	V
$I_D$	Continuous Drain Current ( $T_C=25^\circ C$ )	7	A
	Continuous Drain Current ( $T_C=100^\circ C$ )	4.4	
$I_{DM}$	Drain Current-Pulsed ①	28	A
$V_{GS}$	Gate-to-Source Voltage	+ 30	V
$E_{AS}$	Single Pulsed Avalanche Energy ②	535	mJ
$I_{AR}$	Avalanche Current ①	7	A
$E_{AR}$	Repetitive Avalanche Energy ①	14.7	mJ
dv/dt	Peak Diode Recovery dv/dt ③	3.0	V/ns
$P_D$	Total Power Dissipation ( $T_C=25^\circ C$ )	147	W
	Linear Derating Factor	1.18	
$T_J, T_{STG}$	Operating Junction and Storage Temperature Range	- 55 to +150	$^\circ C$
$T_L$	Maximum Lead Temp. for Soldering Purposes, 1/8 " from case for 5-seconds	300	

**Thermal Resistance**

Symbol	Characteristic	Typ.	Max.	Units
$R_{\theta JC}$	Junction-to-Case	--	0.85	$^\circ C/W$
$R_{\theta CS}$	Case-to-Sink	0.5	--	
$R_{\theta JA}$	Junction-to-Ambient	--	62.5	

### Electrical Characteristics ( $T_C=25^\circ\text{C}$ unless otherwise specified)

Symbol	Characteristic	Min.	Typ.	Max.	Units	Test Condition
$BV_{DSS}$	Drain-Source Breakdown Voltage	600	--	--	V	$V_{GS}=0V, I_D=250\mu A$
$\Delta BV/\Delta T_J$	Breakdown Voltage Temp. Coeff.	--	0.65	--	$V/^\circ\text{C}$	$I_D=250\mu A$ <b>See Fig 7</b>
$V_{GS(th)}$	Gate Threshold Voltage	2.0	--	4.0	V	$V_{DS}=5V, I_D=250\mu A$
$I_{GSS}$	Gate-Source Leakage, Forward	--	--	100	nA	$V_{GS}=30V$
	Gate-Source Leakage, Reverse	--	--	-100		$V_{GS}=-30V$
$I_{DSS}$	Drain-to-Source Leakage Current	--	--	25	$\mu A$	$V_{DS}=600V$
		--	--	250		$V_{DS}=480V, T_C=125^\circ\text{C}$
$R_{DS(on)}$	Static Drain-Source On-State Resistance	--	--	1.2	$\Omega$	$V_{GS}=10V, I_D=3.5A$ ④
$g_{fs}$	Forward Transconductance	--	5.73	--	$\bar{O}$	$V_{DS}=50V, I_D=3.5A$ ④
$C_{iss}$	Input Capacitance	--	1150	1500	pF	$V_{GS}=0V, V_{DS}=25V, f=1\text{MHz}$ <b>See Fig 5</b>
$C_{oss}$	Output Capacitance	--	130	150		
$C_{rss}$	Reverse Transfer Capacitance	--	53	62		
$t_{d(on)}$	Turn-On Delay Time	--	18	45	ns	$V_{DD}=300V, I_D=7A,$ $R_G=9.1\Omega$ <b>See Fig 13</b> ④ ⑤
$t_r$	Rise Time	--	19	50		
$t_{d(off)}$	Turn-Off Delay Time	--	72	155		
$t_f$	Fall Time	--	28	65		
$Q_g$	Total Gate Charge	--	49	65	nC	$V_{DS}=480V, V_{GS}=10V,$ $I_D=7A$ <b>See Fig 6 &amp; Fig 12</b> ④ ⑤
$Q_{gs}$	Gate-Source Charge	--	8.4	--		
$Q_{gd}$	Gate-Drain("Miller") Charge	--	22.1	--		

### Source-Drain Diode Ratings and Characteristics

Symbol	Characteristic	Min.	Typ.	Max.	Units	Test Condition
$I_S$	Continuous Source Current	--	--	7	A	Integral reverse pn-diode in the MOSFET
$I_{SM}$	Pulsed-Source Current ①	--	--	28		
$V_{SD}$	Diode Forward Voltage ④	--	--	1.4	V	$T_J=25^\circ\text{C}, I_S=7A, V_{GS}=0V$
$t_{rr}$	Reverse Recovery Time	--	415	--	ns	$T_J=25^\circ\text{C}, I_F=7A$
$Q_{rr}$	Reverse Recovery Charge	--	3.8	--	$\mu\text{C}$	$di_F/dt=100A/\mu\text{s}$ ④

#### Notes ;

- ① Repetitive Rating : Pulse Width Limited by Maximum Junction Temperature
- ②  $L=20\text{mH}, I_{AS}=7A, V_{DD}=50V, R_G=27\Omega$ , Starting  $T_J=25^\circ\text{C}$
- ③  $I_{SD}\leq 7A, di/dt\leq 120A/\mu\text{s}, V_{DD}\leq BV_{DSS}$ , Starting  $T_J=25^\circ\text{C}$
- ④ Pulse Test : Pulse Width =  $250\mu\text{s}$ , Duty Cycle  $\leq 2\%$
- ⑤ Essentially Independent of Operating Temperature

**Fig 1. Output Characteristics**

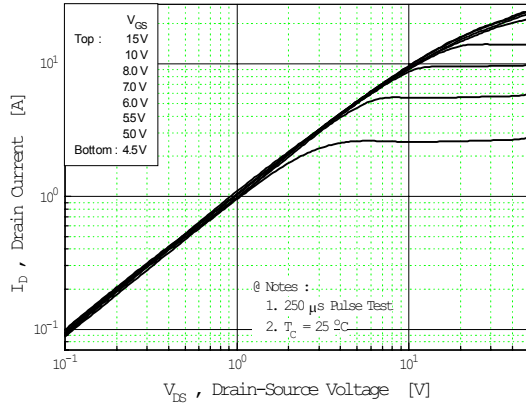

**Fig 2. Transfer Characteristics**

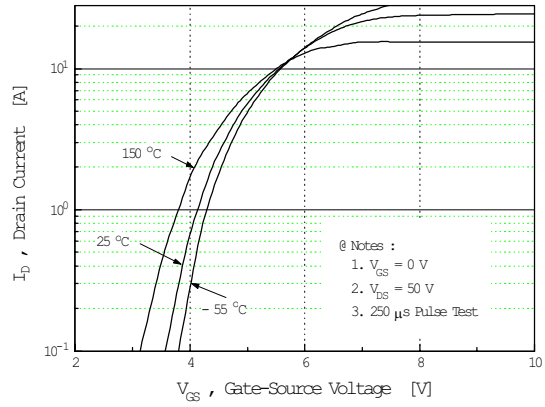

**Fig 3. On-Resistance vs. Drain Current**

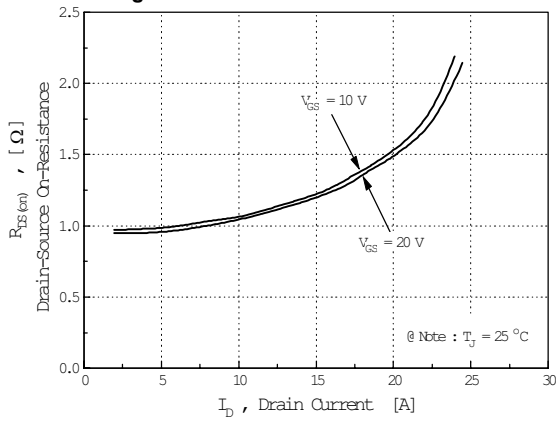

**Fig 4. Source-Drain Diode Forward Voltage**

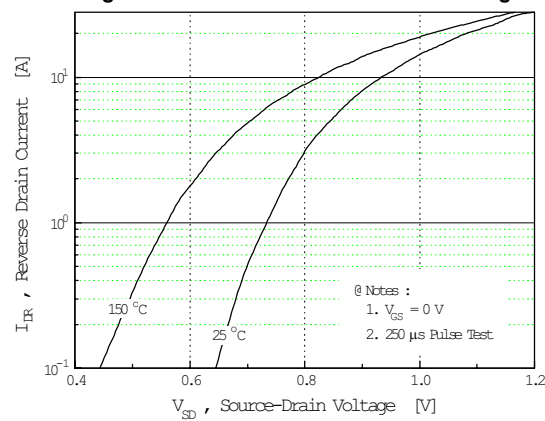

**Fig 5. Capacitance vs. Drain-Source Voltage**

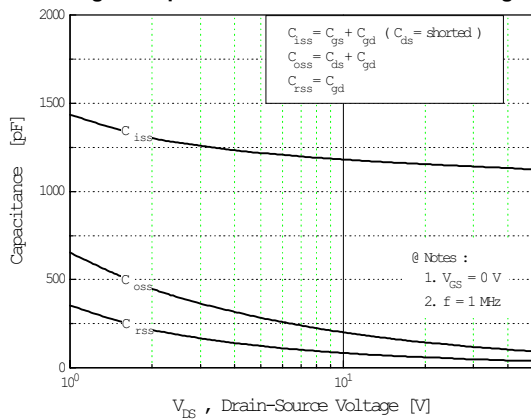

**Fig 6. Gate Charge vs. Gate-Source Voltage**

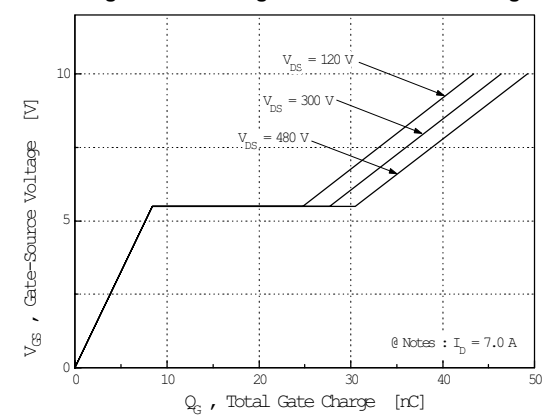

# SSP7N60A

# N-CHANNEL POWER MOSFET

**Fig 7. Breakdown Voltage vs. Temperature**

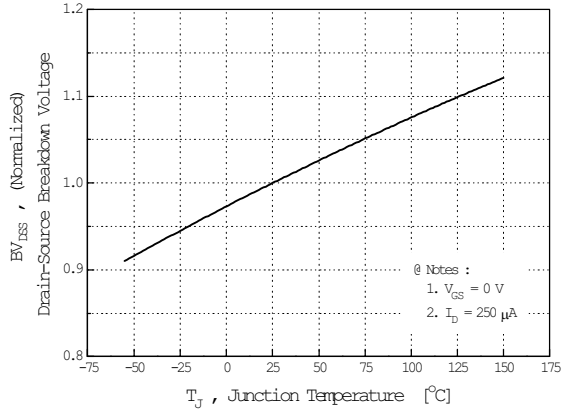

**Fig 8. On-Resistance vs. Temperature**

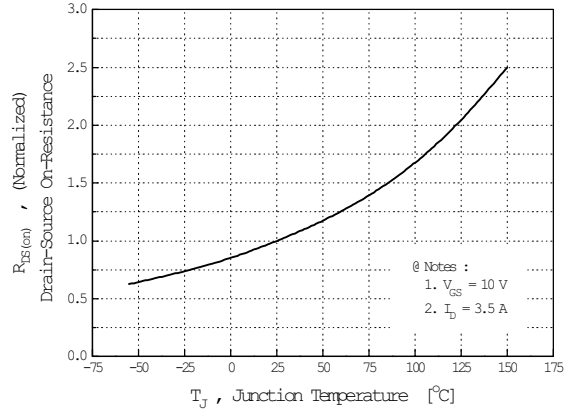

**Fig 9. Max. Safe Operating Area**

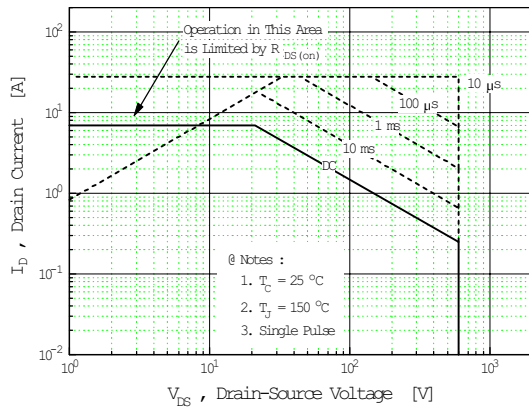

**Fig 10. Max. Drain Current vs. Case Temperature**

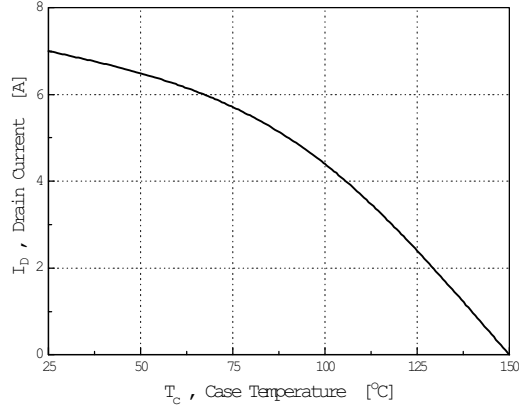

**Fig 11. Thermal Response**

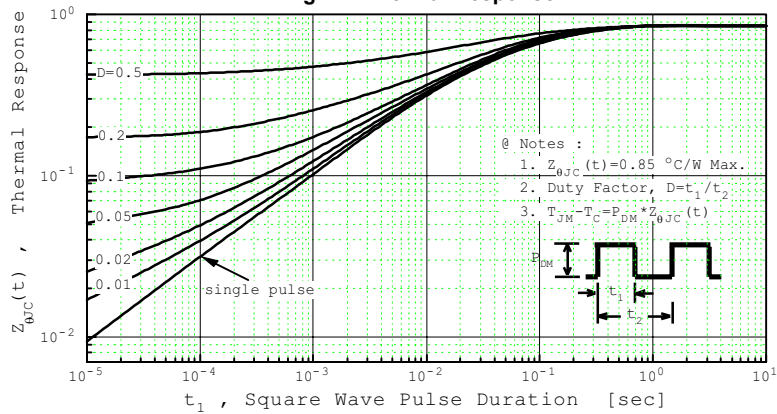

**Fig 12. Gate Charge Test Circuit & Waveform**

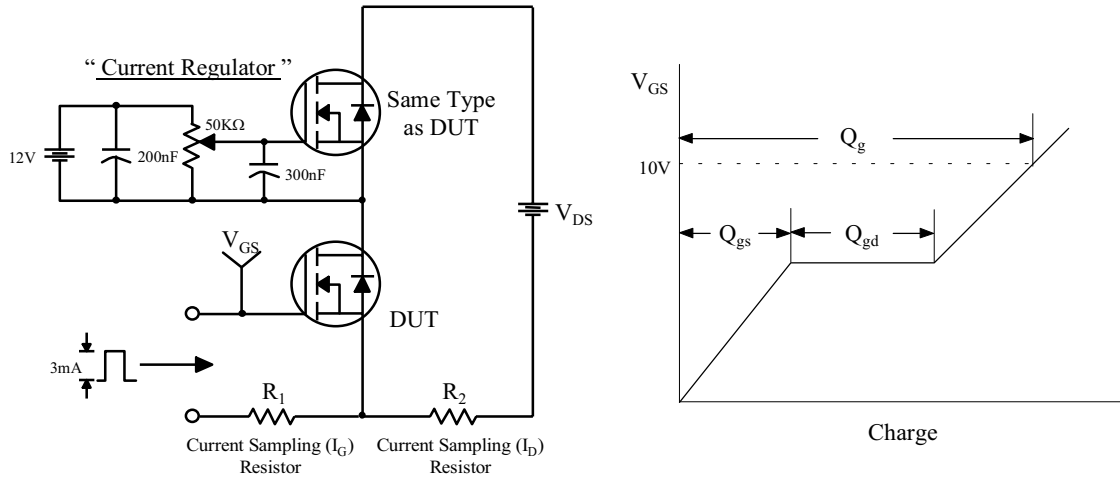

**Fig 13. Resistive Switching Test Circuit & Waveforms**

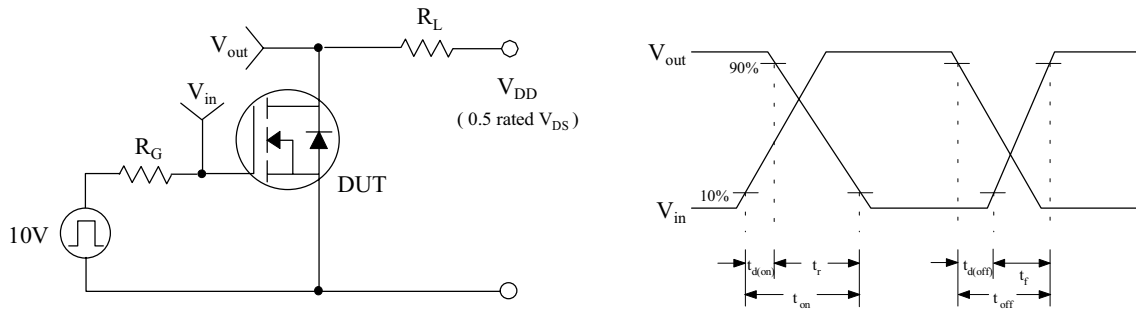

**Fig 14. Unclamped Inductive Switching Test Circuit & Waveforms**

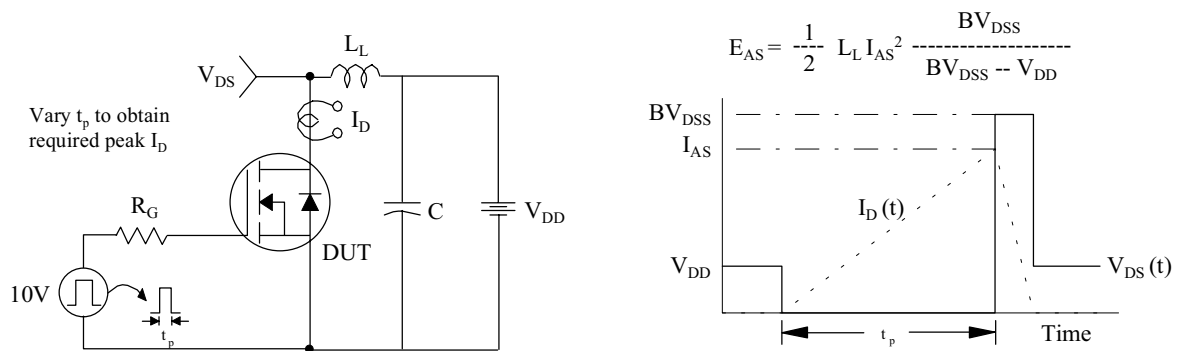

Fig 15. Peak Diode Recovery dv/dt Test Circuit & Waveforms

