

FEATURES

- Avalanche Rugged Technology
- Rugged Gate Oxide Technology
- Lower Input Capacitance
- Improved Gate Charge
- Extended Safe Operating Area
- Lower Leakage Current : 25 μ A (Max.) @ $V_{DS} = 800V$
- Low $R_{DS(ON)}$: 4.688 Ω (Typ.)

$$BV_{DSS} = 800 V$$

$$R_{DS(on)} = 6.0 \Omega$$

$$I_D = 1.5 A$$

TO-220F

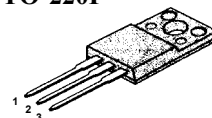

1.Gate 2. Drain 3. Source

Absolute Maximum Ratings

| Symbol | Characteristic | Value | Units |
|----------------|---|--------------|------------|
| V_{DSS} | Drain-to-Source Voltage | 800 | V |
| I_D | Continuous Drain Current ($T_C=25^\circ C$) | 1.5 | A |
| | Continuous Drain Current ($T_C=100^\circ C$) | 0.9 | |
| I_{DM} | Drain Current-Pulsed ① | 8 | A |
| V_{GS} | Gate-to-Source Voltage | ± 30 | V |
| E_{AS} | Single Pulsed Avalanche Energy ② | 216 | mJ |
| I_{AR} | Avalanche Current ① | 1.5 | A |
| E_{AR} | Repetitive Avalanche Energy ① | 3 | mJ |
| dv/dt | Peak Diode Recovery dv/dt ③ | 2.0 | V/ns |
| P_D | Total Power Dissipation ($T_C=25^\circ C$) | 30 | W |
| | Linear Derating Factor | 0.24 | |
| T_J, T_{STG} | Operating Junction and Storage Temperature Range | - 55 to +150 | $^\circ C$ |
| T_L | Maximum Lead Temp. for Soldering Purposes, 1/8" from case for 5-seconds | 300 | |

Thermal Resistance

| Symbol | Characteristic | Typ. | Max. | Units |
|-----------------|---------------------|------|------|--------------|
| $R_{\theta JC}$ | Junction-to-Case | | 4.17 | $^\circ C/W$ |
| $R_{\theta JA}$ | Junction-to-Ambient | | 62.5 | |

Electrical Characteristics ($T_C=25^\circ\text{C}$ unless otherwise specified)

| Symbol | Characteristic | Min. | Typ. | Max. | Units | Test Condition |
|------------------------|---|------|------|------|-----------|---|
| BV_{DSS} | Drain-Source Breakdown Voltage | 800 | -- | -- | V | $V_{GS}=0V, I_D=250\mu A$ |
| $\Delta BV/\Delta T_J$ | Breakdown Voltage Temp. Coeff. | -- | 1.06 | -- | V/°C | $I_D=250\mu A$ See Fig 7 |
| $V_{GS(th)}$ | Gate Threshold Voltage | 2.0 | -- | 3.5 | V | $V_{DS}=5V, I_D=250\mu A$ |
| I_{GSS} | Gate-Source Leakage, Forward | -- | -- | 100 | nA | $V_{GS}=30V$ |
| | Gate-Source Leakage, Reverse | -- | -- | -100 | | $V_{GS}=-30V$ |
| I_{DSS} | Drain-to-Source Leakage Current | -- | -- | 25 | μA | $V_{DS}=800V$ |
| | | -- | -- | 250 | | $V_{DS}=640V, T_C=125^\circ C$ |
| $R_{DS(on)}$ | Static Drain-Source On-State Resistance | -- | -- | 6.0 | Ω | $V_{GS}=10V, I_D=0.85A$ ④* |
| g_{fs} | Forward Transconductance | -- | 1.32 | -- | \bar{O} | $V_{DS}=50V, I_D=0.85A$ ④ |
| C_{iss} | Input Capacitance | -- | 425 | 550 | pF | $V_{GS}=0V, V_{DS}=25V, f=1MHz$ See Fig 5 |
| C_{oss} | Output Capacitance | -- | 45 | 55 | | |
| C_{rss} | Reverse Transfer Capacitance | -- | 19 | 25 | | |
| $t_{d(on)}$ | Turn-On Delay Time | -- | 15 | 40 | ns | $V_{DD}=400V, I_D=2A,$ $R_G=16\Omega$ See Fig 13 ④ ⑤ |
| t_r | Rise Time | -- | 22 | 55 | | |
| $t_{d(off)}$ | Turn-Off Delay Time | -- | 38 | 85 | | |
| t_f | Fall Time | -- | 18 | 45 | | |
| Q_g | Total Gate Charge | -- | 22 | 30 | nC | $V_{DS}=640V, V_{GS}=10V,$ $I_D=2A$ See Fig 6 & Fig 12 ④ ⑤ |
| Q_{gs} | Gate-Source Charge | -- | 3.8 | -- | | |
| Q_{gd} | Gate-Drain("Miller") Charge | -- | 11.6 | -- | | |

Source-Drain Diode Ratings and Characteristics

| Symbol | Characteristic | Min. | Typ. | Max. | Units | Test Condition |
|----------|---------------------------|------|------|------|---------|---|
| I_S | Continuous Source Current | -- | -- | 1.5 | A | Integral reverse pn-diode in the MOSFET |
| I_{SM} | Pulsed-Source Current ① | -- | -- | 8 | | |
| V_{SD} | Diode Forward Voltage ④ | -- | -- | 1.4 | V | $T_J=25^\circ C, I_S=1.7A, V_{GS}=0V$ |
| t_{rr} | Reverse Recovery Time | -- | 290 | -- | ns | $T_J=25^\circ C, I_F=2A$ |
| Q_{rr} | Reverse Recovery Charge | -- | 0.8 | -- | μC | $di_F/dt=100A/\mu s$ ④ |

Notes ;

- ① Repetitive Rating : Pulse Width Limited by Maximum Junction Temperature
- ② $L=180mH, I_{AS}=1.5A, V_{DD}=50V, R_G=27\Omega,$ Starting $T_J=25^\circ C$
- ③ $I_{SD}\leq 2A, di/dt\leq 90A/\mu s, V_{DD}\leq BV_{DSS},$ Starting $T_J=25^\circ C$
- ④ Pulse Test : Pulse Width = 250 $\mu s,$ Duty Cycle $\leq 2\%$
- ⑤ Essentially Independent of Operating Temperature

Fig 1. Output Characteristics

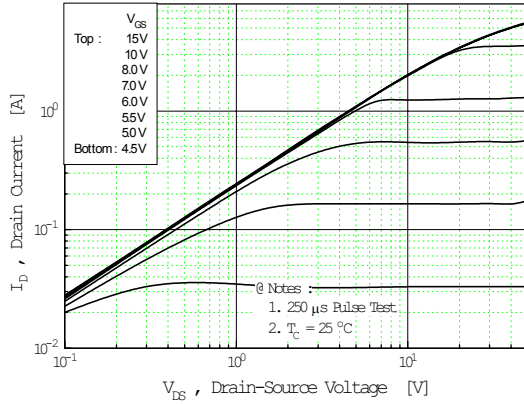

Fig 2. Transfer Characteristics

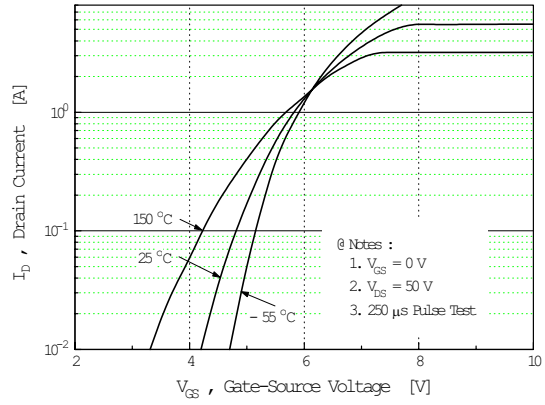

Fig 3. On-Resistance vs. Drain Current

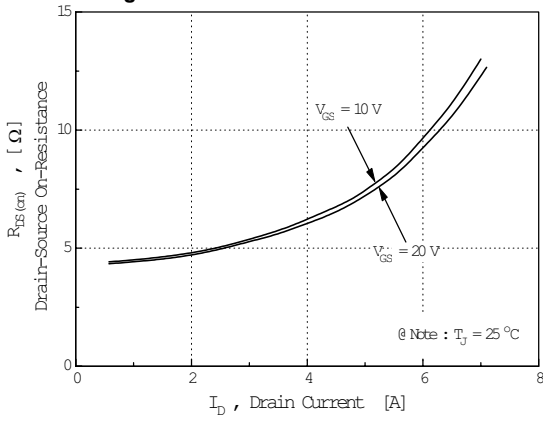

Fig 4. Source-Drain Diode Forward Voltage

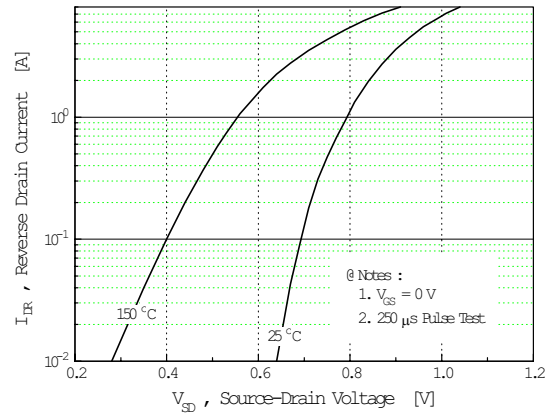

Fig 5. Capacitance vs. Drain-Source Voltage

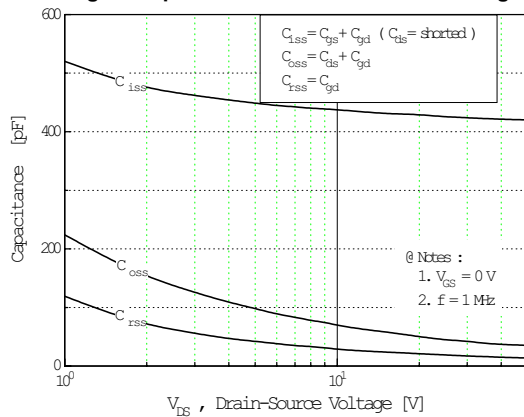
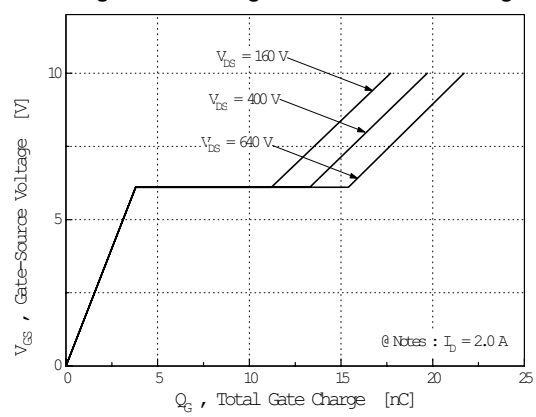

Fig 6. Gate Charge vs. Gate-Source Voltage



SSS2N80A

N-CHANNEL POWER MOSFET

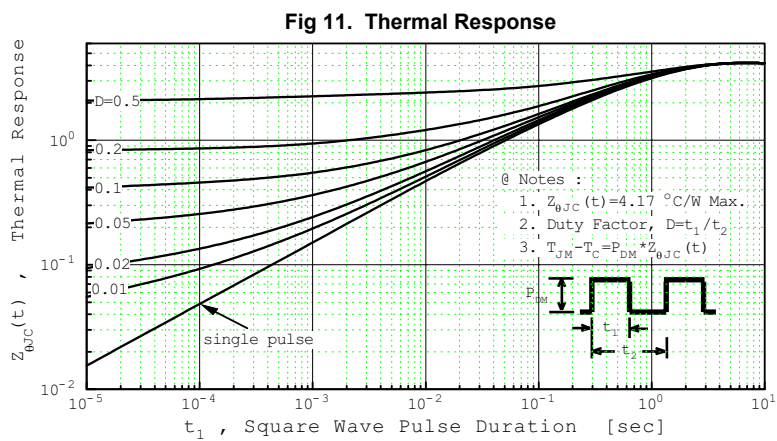
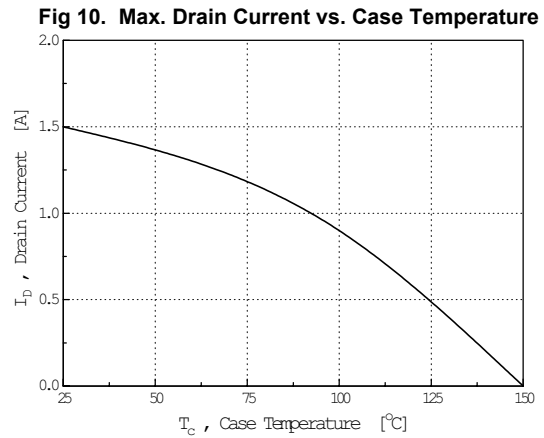
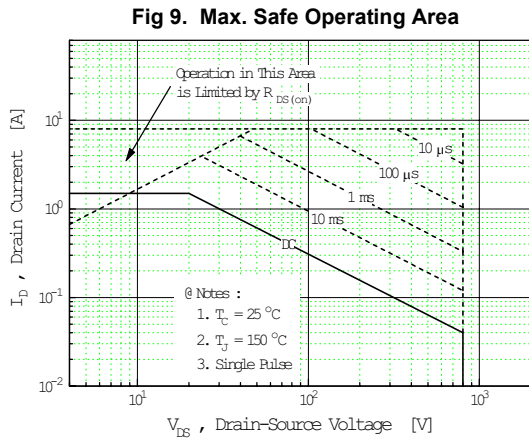
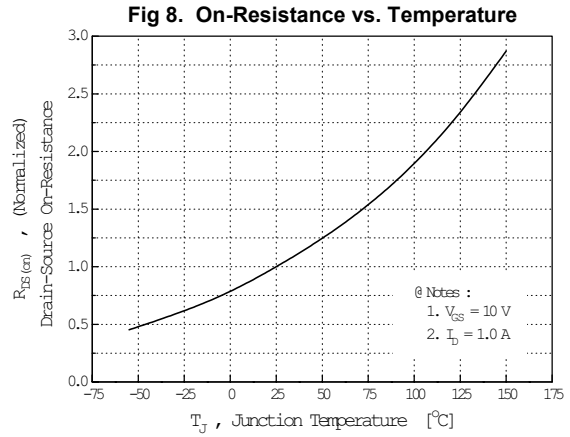
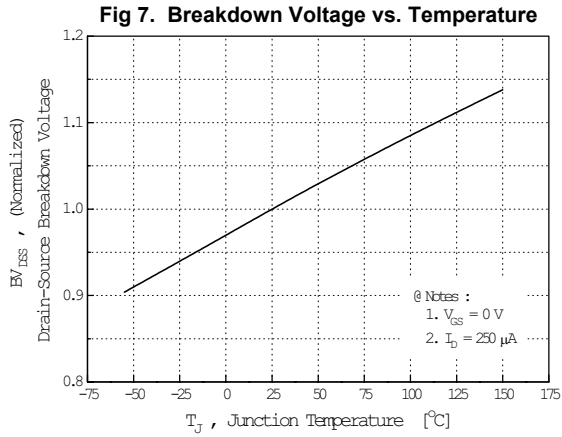

Fig 12. Gate Charge Test Circuit & Waveform

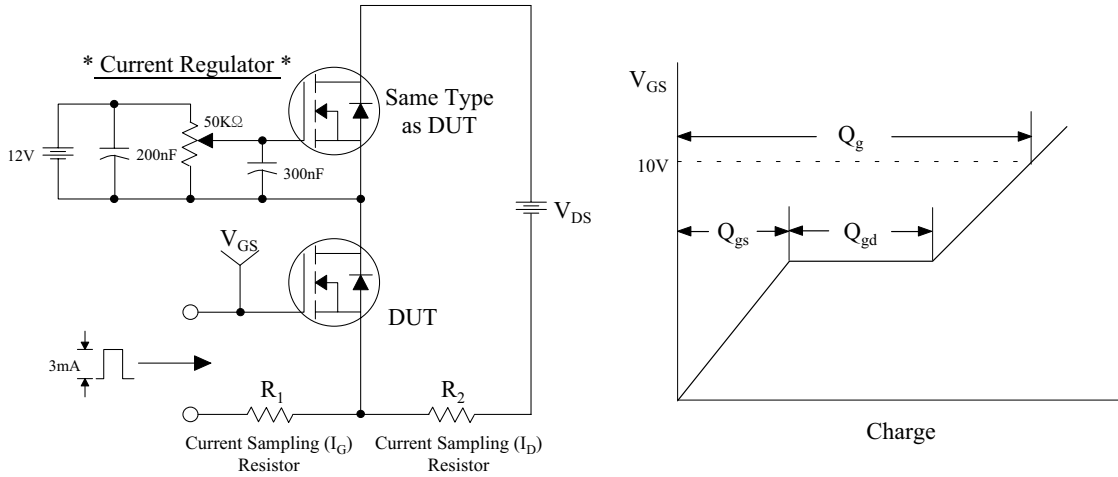

Fig 13. Resistive Switching Test Circuit & Waveforms

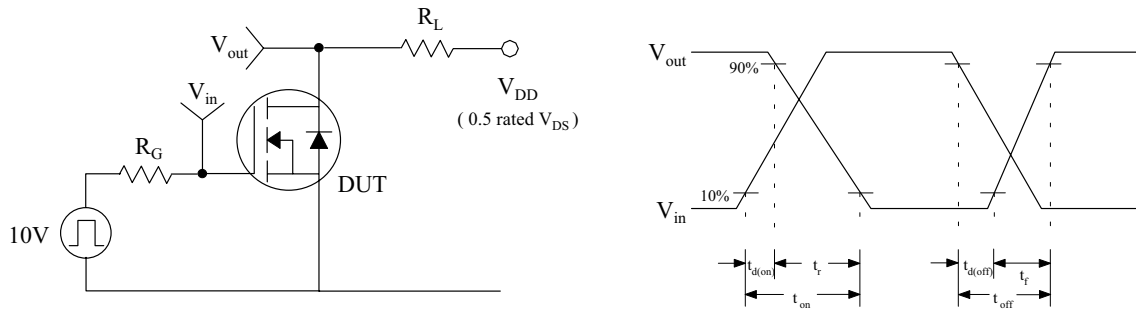

Fig 14. Unclamped Inductive Switching Test Circuit & Waveforms

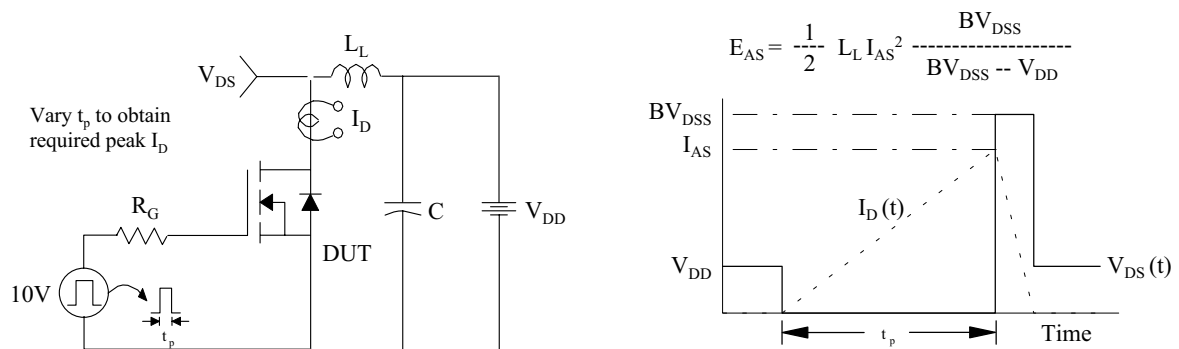

Fig 15. Peak Diode Recovery dv/dt Test Circuit & Waveforms

