

SANYO

No. 4549A

STK4026 II**AF Power Amplifier (Split Power Supply)
(25 W min, THD = 0.4 %)****Features**

- Compact packaging supports slimmer set designs
- Series designed for 20 up to 200 W and pin-compatibility
- Simpler heat sink design facilitates thermal design of slim stereo sets
- The pulse noises associated with turning the power on and off have been reduced by the adoption of fixed current circuits
- Supports addition of electronic circuits for thermal shutdown and load-short protection circuit as well as pop noise muting which occurs when the power supply switch is turned on and off

Package Dimensions

unit: mm

4033

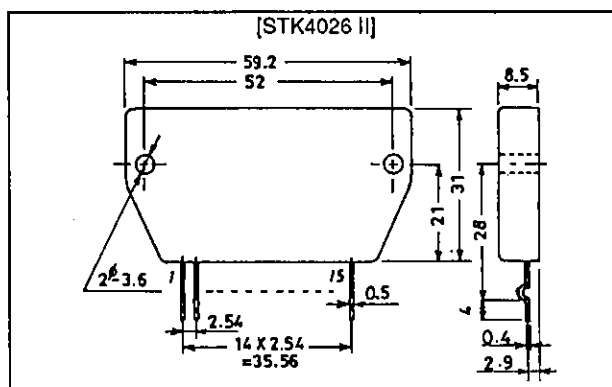
**Specifications****Maximum Ratings at $T_a = 25^\circ\text{C}$**

Parameter	Symbol	Conditions	Ratings	Unit
Maximum supply voltage	$V_{CC \text{ max}}$		± 38	V
Thermal resistance	θ_{j-c}		2.4	$^\circ\text{C/W}$
Junction temperature	T_j		150	$^\circ\text{C}$
Operating substrate temperature	T_c		125	$^\circ\text{C}$
Storage temperature	T_{stg}		-30 to +125	$^\circ\text{C}$
Available time for load shorted	t_S^{*1}	$V_{CC} = \pm 26 \text{ V}, R_L = 8 \Omega, f = 50 \text{ Hz}, P_O = 25 \text{ W}$	2	s

Recommended Operating Conditions $T_a = 25^\circ\text{C}$

Parameter	Symbol	Conditions	Ratings	Unit
Recommended supply voltage	V_{CC}		± 26	V
Load resistance	R_L		8	Ω

Operating Characteristics at $T_a = 25^\circ\text{C}, V_{CC} = \pm 26 \text{ V}, R_L = 8 \Omega, V_G = 40 \text{ dB}, R_g = 600 \Omega, R_L$ (noninductive)

Parameter	Symbol	Conditions	Ratings			Unit
			min	typ	max	
Quiescent current	I_{CCO}	$V_{CC} = \pm 30 \text{ V}$	10	20	50	mA
Output power	$P_O (1)$	THD = 0.4%, $f = 20 \text{ Hz}$ to 20 kHz	25			W
	$P_O (2)$	$V_{CC} = \pm 22 \text{ V}, \text{THD} = 1.0\%, R_L = 4 \Omega, f = 1 \text{ kHz}$	25			W
Total harmonic distortion	THD	$P_O = 1.0 \text{ W}, f = 1 \text{ kHz}$			0.3	%
Frequency response	f_L, f_H	$P_O = 1.0 \text{ W}, +0, -3 \text{ dB}$		20 to 50k		Hz
Input resistance	r_i	$P_O = 1.0 \text{ W}, f = 1 \text{ kHz}$		55		k Ω
Output noise voltage	V_{NO}^{*2}	$V_{CC} = \pm 30 \text{ V}, R_g = 10 \text{ k}\Omega$			1.2	mVrms
Neutral voltage	V_N	$V_{CC} = \pm 30 \text{ V}$	-70	0	+70	mV

Note: Use rated power supply for test unless otherwise specified.

1. Use the transformer power supply shown on the next page when measuring the available time for load shorted and the output noise voltage.
2. Output noise voltage represents the peak value on the rms scale (VTVM). The noise voltage waveform does not include the pulse noise.

SANYO Electric Co., Ltd. Semiconductor Business Headquarters

TOKYO OFFICE Tokyo Bldg., 1-10, 1 Chome, Ueno, Taito-ku, TOKYO, 110 JAPAN

STK4026II

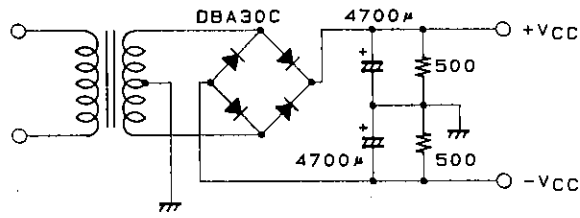

Unit (resistance:Ω , capacitance: F)

Specified Transformer Power Supply
(RP-25 equivalent)

Equivalent Circuit

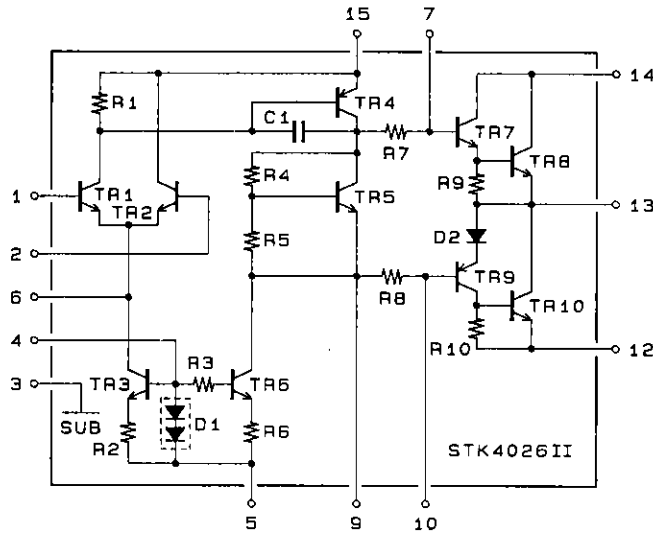

Sample Application Circuit: 25 W min AF Power Amplifier

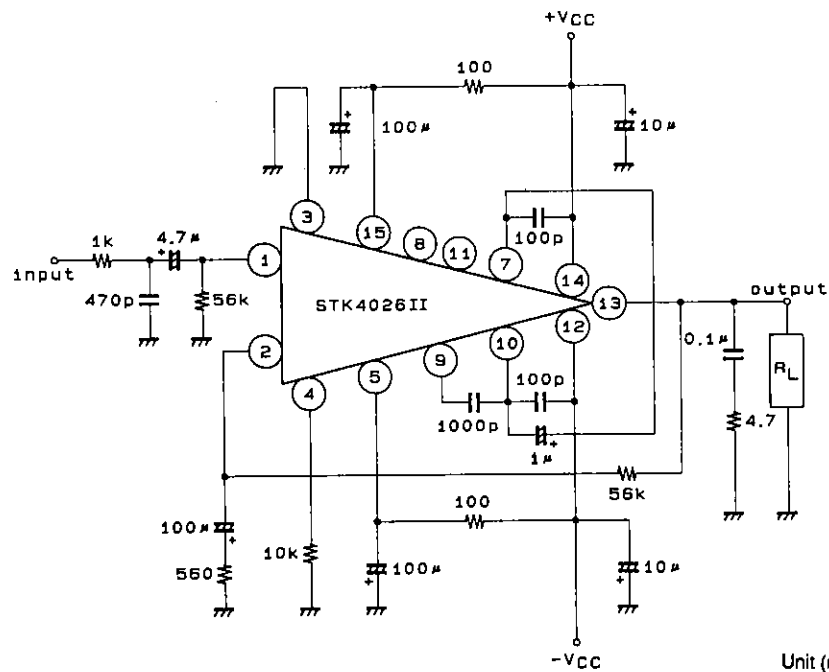

Unit (resistance:Ω , capacitance: F)

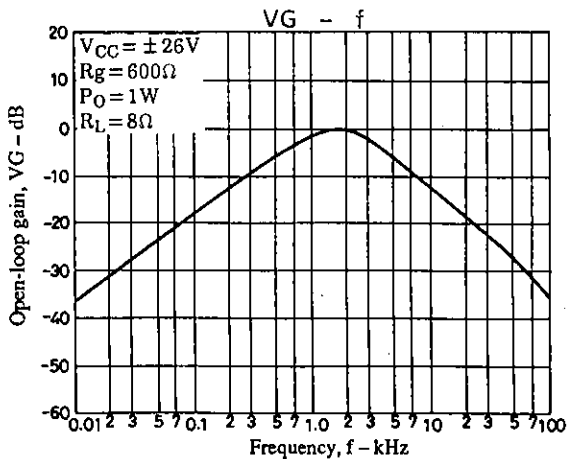
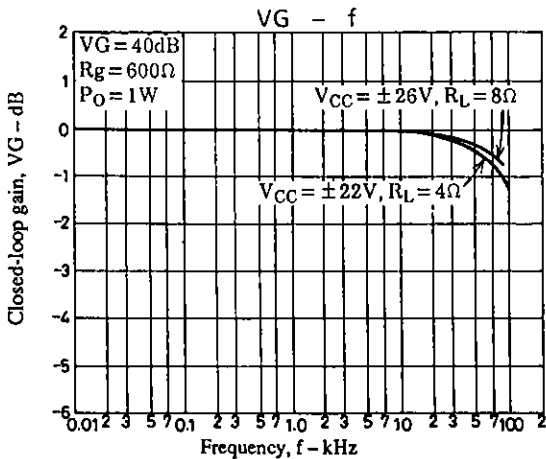
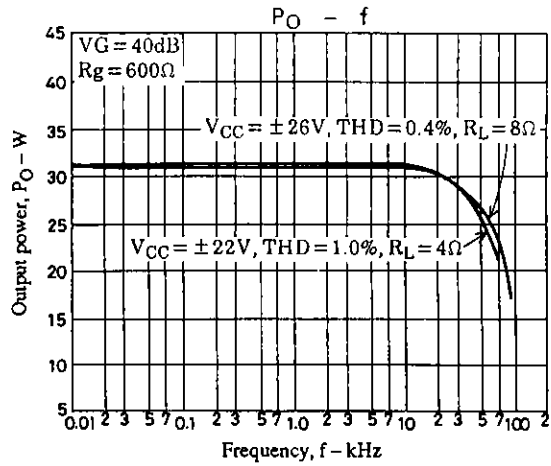
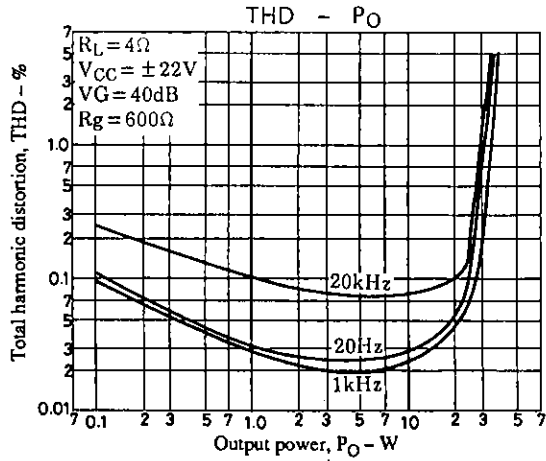
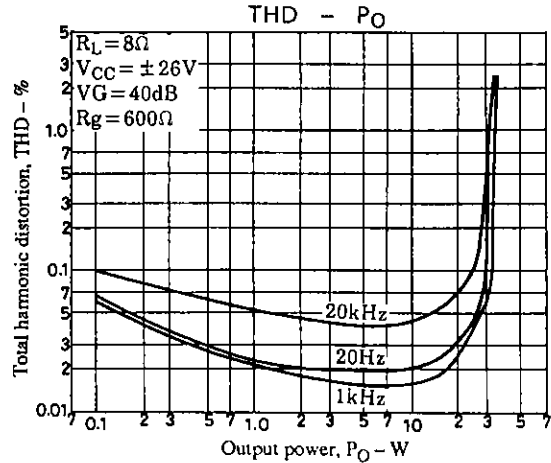
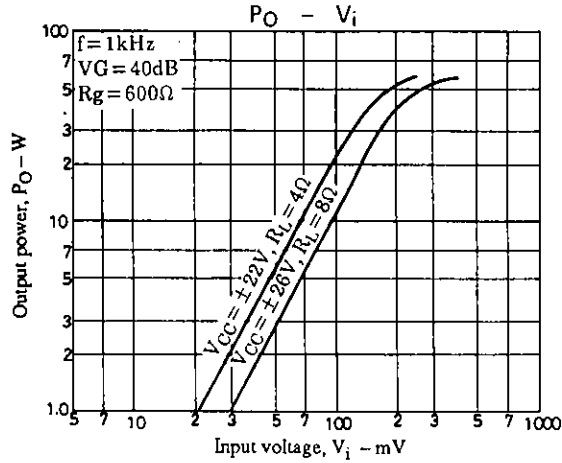
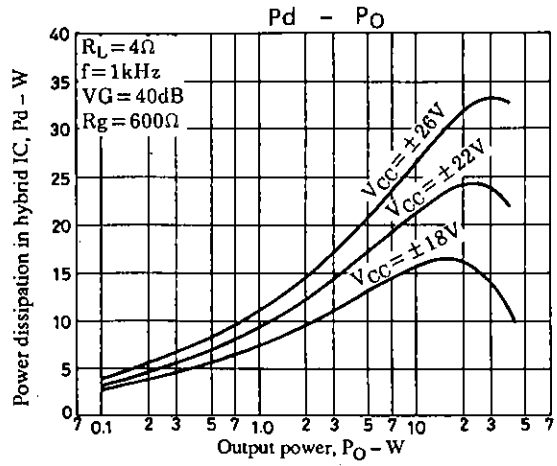
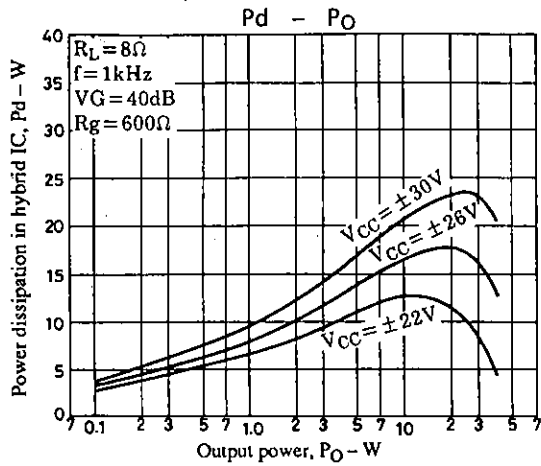

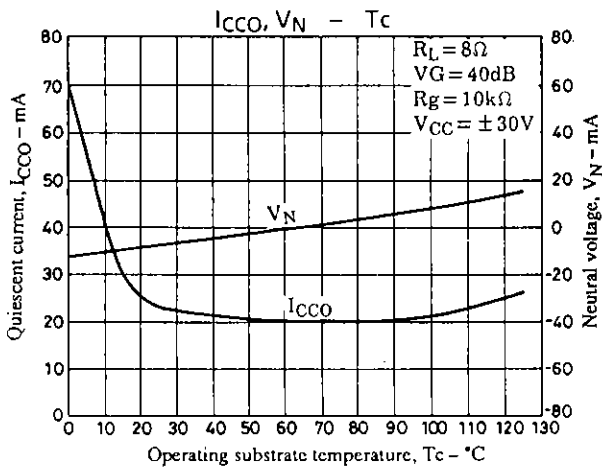
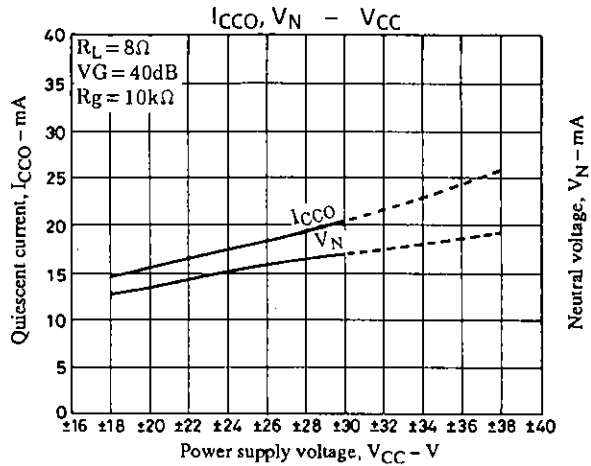
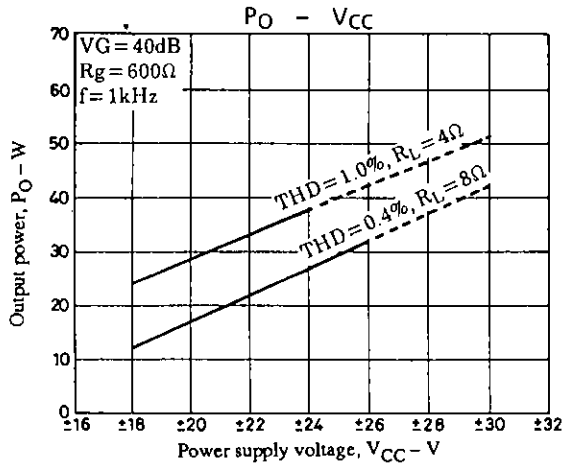

■ No products described or contained herein are intended for use in surgical implants, life-support systems, aerospace equipment, nuclear power control systems, vehicles, disaster/crime-prevention equipment and the like, the failure of which may directly or indirectly cause injury, death or property loss.

■ Anyone purchasing any products described or contained herein for an above-mentioned use shall:

- ① Accept full responsibility and indemnify and defend SANYO ELECTRIC CO., LTD., its affiliates, subsidiaries and distributors and all their officers and employees, jointly and severally, against any and all claims and litigation and all damages, cost and expenses associated with such use;
- ② Not impose any responsibility for any fault or negligence which may be cited in any such claim or litigation on SANYO ELECTRIC CO., LTD., its affiliates, subsidiaries and distributors or any of their officers and employees jointly or severally.

■ Information (including circuit diagrams and circuit parameters) herein is for example only; it is not guaranteed for volume production. SANYO believes information herein is accurate and reliable, but no guarantees are made or implied regarding its use or any infringements of intellectual property rights or other rights of third parties.

This catalog provides information as of June, 1995. Specifications and information herein are subject to change without notice.