

<b>SANYO</b>	No. 4610A	<b>STK4211II</b>
	<b>2ch AF Power Amplifier (Split Power Supply) (70W + 70W min, THD = 0.4%)</b>	

**Features**

- Muting circuit built-in to isolate all types of shock noise
- Current mirror circuit for low 0.4% total harmonic distortion
- Pin compatible with the STK4201V series (THD = 0.08%) and the STK4141X series (THD = 0.02%)

**Package Dimensions**

unit: mm

4086A

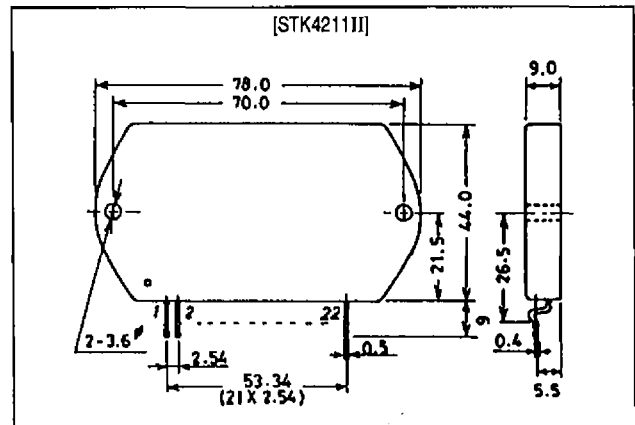

## Specifications

### Maximum Ratings at $T_a = 25^\circ\text{C}$

Parameter	Symbol	Conditions	Ratings	Unit
Maximum supply voltage	$V_{CC\text{ max}}$		$\pm 60$	V
Thermal resistance	$\theta_{j-c}$		1.5	$^\circ\text{C/W}$
Junction temperature	$T_j$		150	$^\circ\text{C}$
Operating substrate temperature	$T_c$		125	$^\circ\text{C}$
Storage temperature	$T_{stg}$		-30 to +125	$^\circ\text{C}$
Available time for load short-circuit	$t_s$	$V_{CC} = \pm 42\text{V}$ , $R_L = 8\Omega$ , $f = 50\text{Hz}$ , $P_O = 70\text{W}$	1	s

### Recommended Operating Conditions at $T_a = 25^\circ\text{C}$

Parameter	Symbol	Conditions	Ratings	Unit
Recommended supply voltage	$V_{CC}$		$\pm 42$	V
Load resistance	$R_L$		8	$\Omega$

### Operating Characteristics at $T_a = 25^\circ\text{C}$ , $V_{CC} = \pm 42\text{V}$ , $R_L = 8\Omega$ (noninductive load), $R_g = 600\Omega$ , $V_G = 40\text{dB}$

Parameter	Symbol	Conditions	min	typ	max	Unit
Quiescent current	$I_{CCO}$	$V_{CC} = \pm 50.5\text{V}$	20	40	100	mA
Output power	$P_O$	THD = 0.4%, $f = 20\text{Hz}$ to 20kHz	70	-	-	W
Total harmonic distortion	THD	$P_O = 1.0\text{W}$ , $f = 1\text{kHz}$	-	-	0.3	%
Frequency response	$f_L, f_H$	$P_O = 1.0\text{W}$ , $_{-3}^{+0}\text{dB}$	-	20 to 50k	-	Hz
Input impedance	$r_i$	$P_O = 1.0\text{W}$ , $f = 1\text{kHz}$	-	55	-	$\text{k}\Omega$
Output noise voltage	$V_{NO}$	$V_{CC} = \pm 50.5\text{V}$ , $R_g = 10\text{k}\Omega$	-	-	1.2	mVrms
Neutral voltage	$V_N$	$V_{CC} = \pm 50.5\text{V}$	-70	0	+70	mV
Muting voltage	$V_M$		-2	-5	-10	V

**Notes.**

All tests are measured using a regulated voltage supply unless otherwise specified.

Available time for load short-circuit and output noise voltage are measured using the transformer supply specified below.

The output noise voltage is the peak value of an average-reading meter with an rms value scale (VTVM). A regulated AC supply (50Hz) should be used to eliminate the effects of AC primary line flicker noise.

### Specified Transformer Supply (MG-200 or Equivalent)

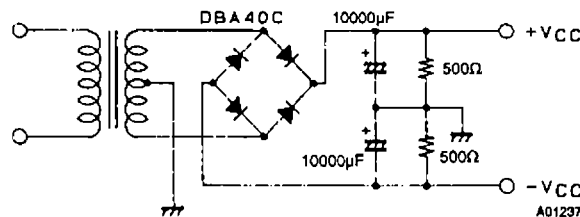

# STK4211II

## Equivalent Circuit

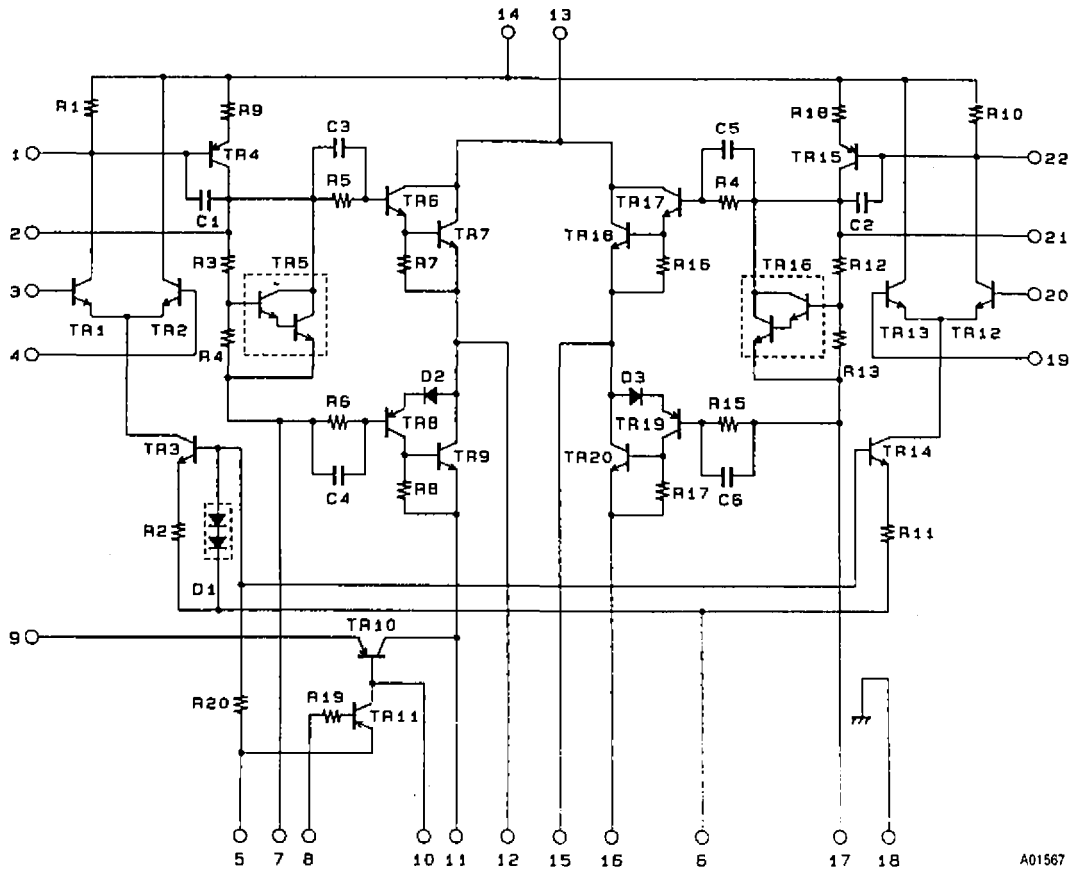

A01567

## Sample Application Circuit (70W min 2-Channel AF Power Amplifier)

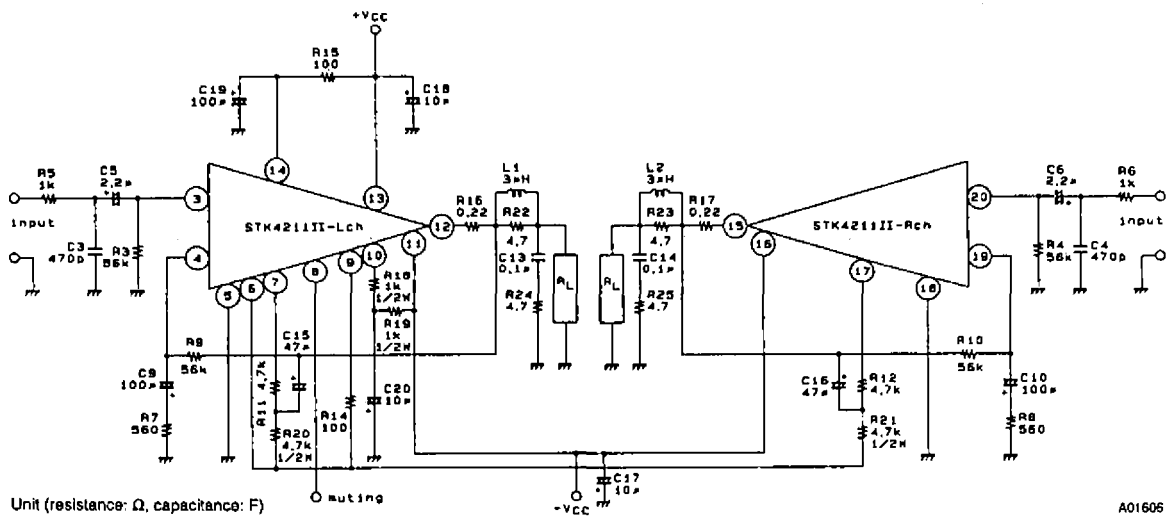

Unit (resistance:  $\Omega$ , capacitance: F)

A01605

Sample Application Circuit PCB Layout (Copper Foil Surface)

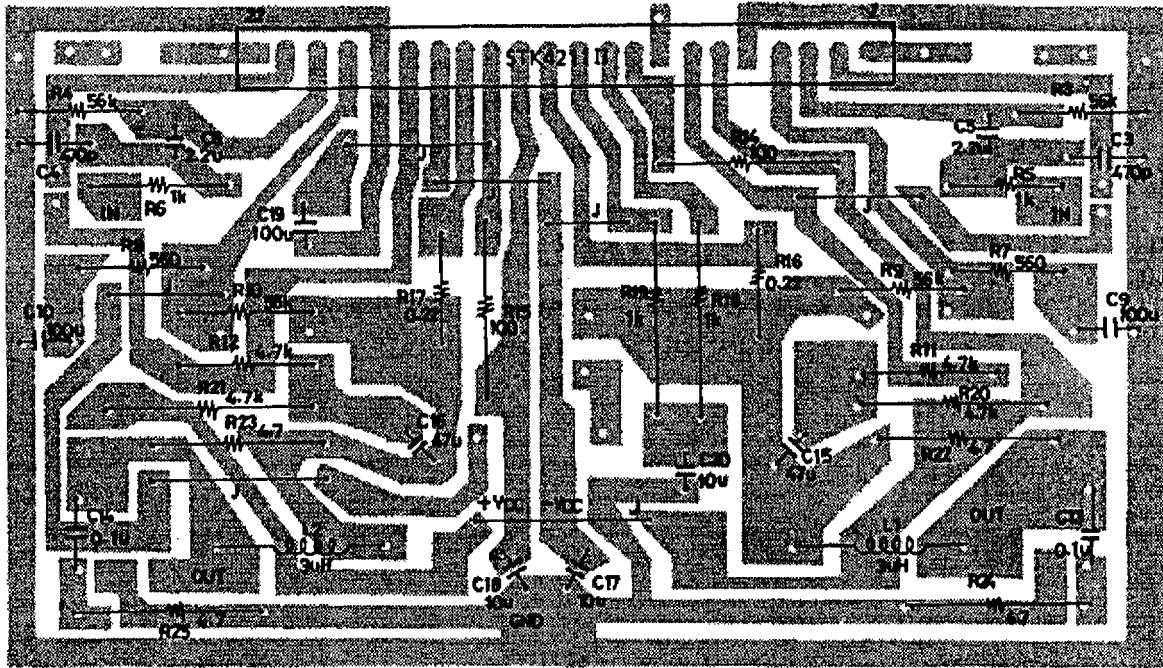

Unit (resistance: Ω; capacitance: F)

External Component Description

C3, C4	Input filter capacitors. These, together with R5 and R6, form filters to reduce high-band noise.
C5, C6	Input coupling capacitors. For DC blocking. Since capacitor reactance becomes larger at lower frequencies, the output noise can be adversely affected by signal source resistance-dependent 1/f noise. In this case, a lower reactance value should be chosen. In order to remove pop noise at power-on, larger values of capacitance should be chosen for C5 and C6, which determine the input time constant, and smaller values for C9 and C10 in the NF circuit.
C9, C10	NF capacitors. These determine the low-side cut-off frequency. $f_L = \frac{1}{2\pi \times C9 \times R7} \text{ [Hz]}$ A Large value should be chosen for C9 to maintain voltage gain at low frequencies. However, because this would tend to increase the shock noise at power-on, a value larger than absolutely necessary should be avoided.
C19	Decoupling capacitors. This removes shock noise and ripple voltage from the supply.
C15, C16	Bootstrap capacitors. If these capacitors are made small, then the total harmonic distortion at low frequencies increases significantly.
C17, C18	Oscillation prevention capacitors. These should be inserted as close as possible to the IC supply pins to reduce supply impedance and hence provide stable IC operation. Electrolytic capacitors are recommended.
C20	Ripple filter capacitor. This forms a ripple filter in combination with internal transistor TR10.
C13, C14	Oscillation prevention capacitors. Mylar capacitors are recommended for their excellent thermal and frequency characteristics.
R5, R6	Input filter resistors.
R3, R4	Input bias resistors. These are used to bias the input pins at zero potential. The input impedance is largely determined by this resistance.
R7, R9 (R8, R10)	Voltage-gain VG setting resistors. VG = 40dB is recommended using R7, R8 = 560Ω, and R9, R10 = 56kΩ. Gain adjustments are best made using R7 or R8. If gain adjustments are made using R7 or R8, then set R3, R4 = R9, R10 to maintain V <sub>N</sub> balance stability.
R11, R20 (R12, R21)	Bootstrap resistors. These resistors determine the quiescent current. Values of 4.7kΩ and 4.7kΩ are recommended.

# STK4211II

R15	Ripple filter resistor. This resistor performs as predriver transistor limiting resistor during load short circuits.
R14	Clipping plus/minus balance resistor.
R18, R19	Ripple filter resistors. When muting transistor TR11 is on, current flows from ground through TR11 to $-V_{CC}$ . Values of $1k\Omega$ (1W) and $1k\Omega$ (1W) are recommended.
R24, R25	Oscillation prevention resistors.
R16, R17	Output limiting resistors.
R22, R23	High-frequency oscillation prevention resistors.
L1, L2	High-frequency oscillation prevention inductors.

## Sample Application Circuit (With Protection and Muting Circuits)

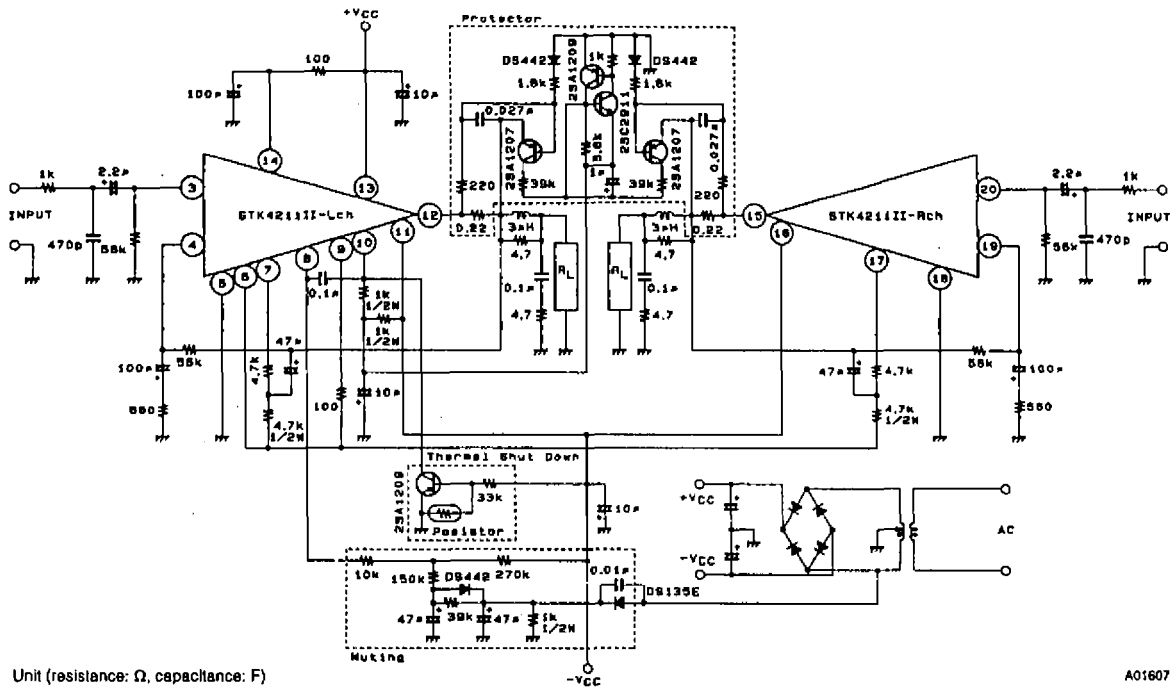

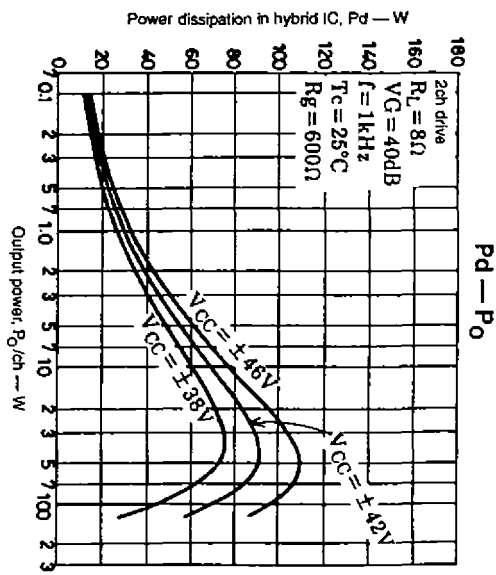
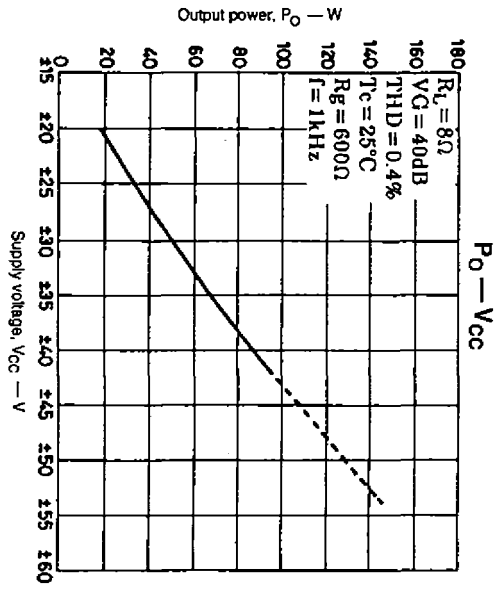

STK4211D

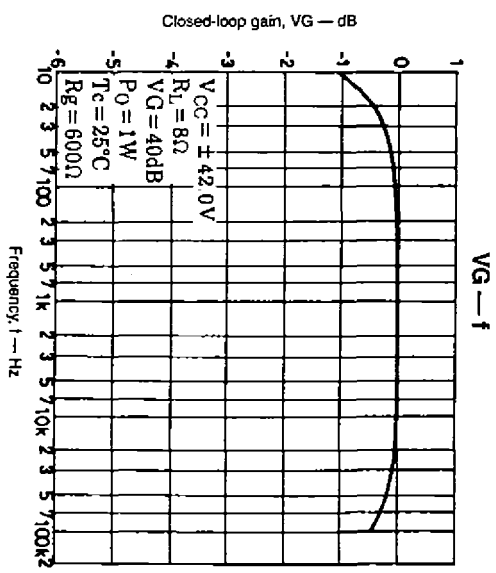
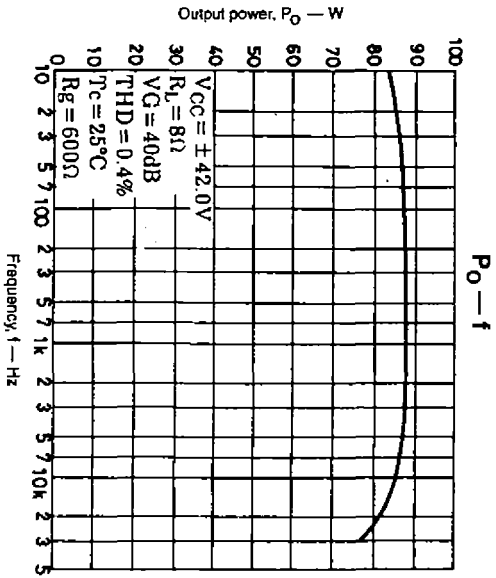
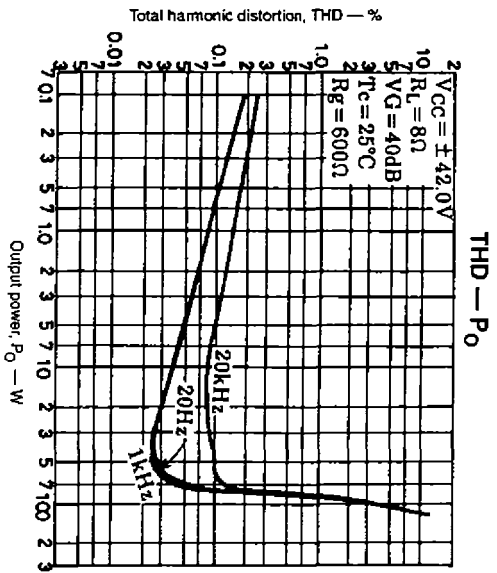
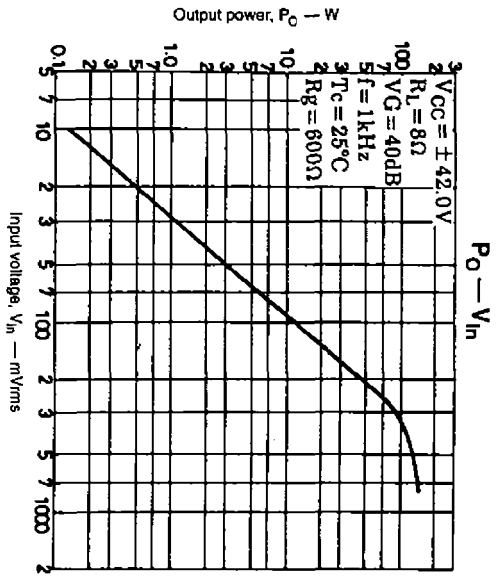

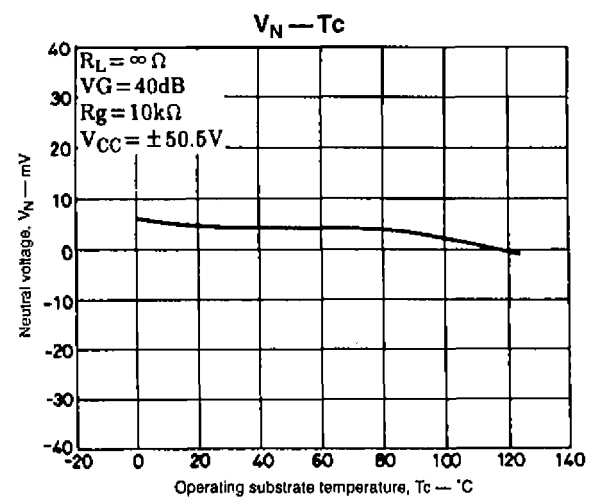
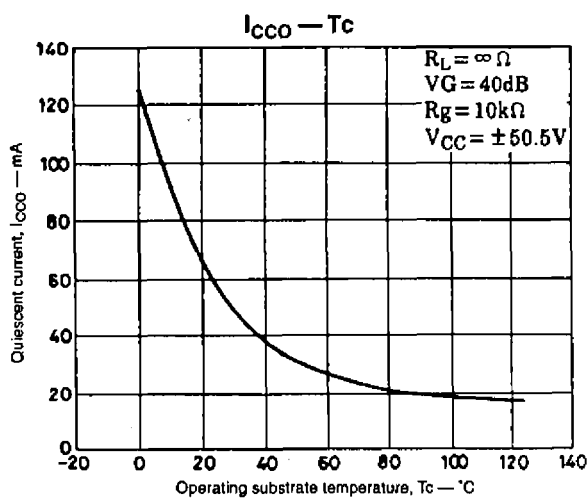
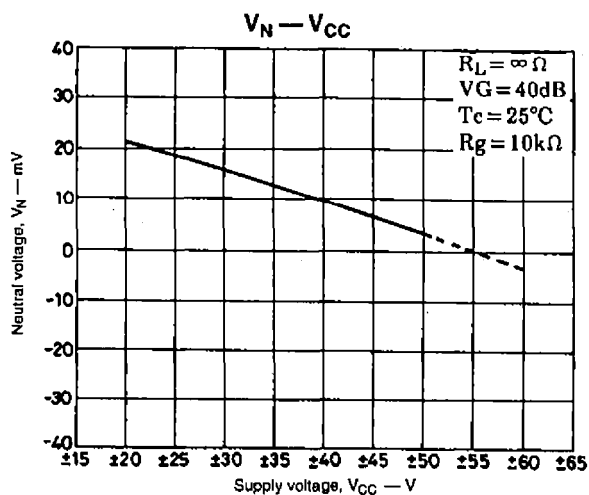
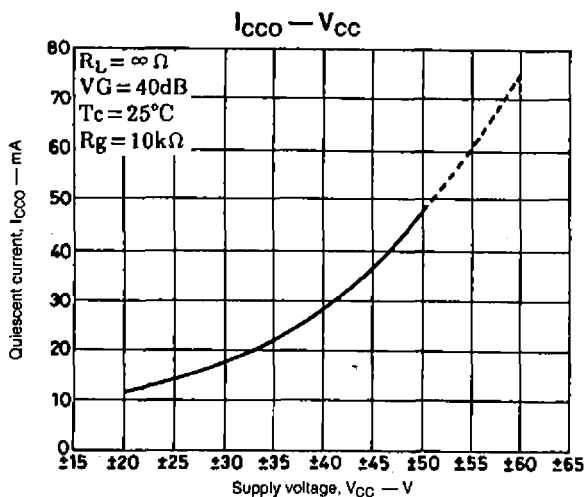

- No products described or contained herein are intended for use in surgical implants, life-support systems, aerospace equipment, nuclear power control systems, vehicles, disaster/crime-prevention equipment and the like, the failure of which may directly or indirectly cause injury, death or property loss.
- Anyone purchasing any products described or contained herein for an above-mentioned use shall:
  - ① Accept full responsibility and indemnify and defend SANYO ELECTRIC CO., LTD., its affiliates, subsidiaries and distributors and all their officers and employees, jointly and severally, against any and all claims and litigation and all damages, cost and expenses associated with such use;
  - ② Not impose any responsibility for any fault or negligence which may be cited in any such claim or litigation on SANYO ELECTRIC CO., LTD., its affiliates, subsidiaries and distributors or any of their officers and employees, jointly or severally.
- Information (including circuit diagrams and circuit parameters) herein is for example only; it is not guaranteed for volume production. SANYO believes information herein is accurate and reliable, but no guarantees are made or implied regarding its use or any infringements of intellectual property rights or other rights of third parties.