

SANKEN ELECTRIC COMPANY, LTD.

S P E C I F I C A T I O N S

Sanken Hybrid Voltage Regulator Module, STR Series
Sanken Part No: STR54041

Messrs :

Date : October 8, 1985
Specification No. : ES85044

1. Features:

- a. Hybrid Voltage Regulator Module incorporated triple diffused planar transistor chips
- b. Transfer Molded
- c. For TV Switch Mode Power Supply
- d. Fixed Output Voltage

2. Equivalent Circuit

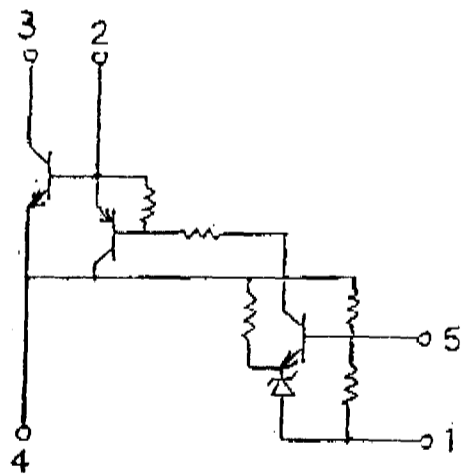

- 1. Vout SENSE (-)
- 2. BASE DRIVE (B)
- 3. IN PUT (C)
- 4. EARTH (E)
- 5. Vo CONT

3. Outline Drawing, Marking and Pin Connections

Refer to Figure 1

- 4. The type number and lot number shall be legitimately marked by white color.



SANKEN ELECTRIC COMPANY, LTD.

5. Absolute Maximum Ratings

Description	Symbol	Unit	Ratings
Maximum Peak Input Voltage	V_{IN}	V	900
Input Current	I_{IN}	A	6 (Pulse 12)
Maximum Power Dissipation	P_D	W	27 ($T_c=100^\circ\text{C}$)*
Operating Temperature	T_{op}	$^\circ\text{C}$	-20-+125 (T_c)
Storage Temperature	T_{stg}	$^\circ\text{C}$	-30-+125
Power Transistor Junction Temperature	T_j	$^\circ\text{C}$	+150

* Recommendation Case Temperature $T_{op}(T_c)=100^\circ\text{C}$ Max

Suggested Silicone Grease

C746: SHIN-ETSU CHEMICAL INDUSTRY CO., LTD.
C747: SHIN-ETSU CHEMICAL INDUSTRY CO., LTD.
YG6260: TOSHIBA SILICONE CO., LTD.
SC102: TORAY SILICONE CO., LTD.

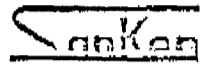

SANKEN ELECTRIC COMPANY, LTD.

6. Electrical Characteristics 1

Description		Conditions	Ratings
Fixed Output Voltage (Detecting Voltage)		$I_{IN}=7mA$, Measurement Circuit 1	$41.8 \pm 0.5V$
Output Voltage Temperature Coefficient		$T_C = -20 \text{--} +100^\circ C$, $I_{IN}=7mA$ Measurement Circuit 1	$\pm 2.0mV/^\circ C$
Power Transistor Characteristics	$V_{CE}(\text{sat})$	$I_C=2A$, $I_B=0.4A$	1.0V Max
	h_{FE}	$V_{CE}=4V$, $I_C=1A$	Min 10 Max 30
	I_{CEX}	$V_{CE}=900V$, $V_{BE}=-1.5V$	1.0mA Max
	$V_{BE}(\text{sat})$	$I_C=2A$, $I_B=0.4A$	1.5V Max
	$R_{\theta j-c}$	Between Junction and Stem Upper Surface	1.8 $^\circ C/W$
	Switching Time	Measurement Circuit 2	t_s
t_f			1.0 μsec Max



SANKEN ELECTRIC COMPANY, LTD.

Measurement Circuit 1.

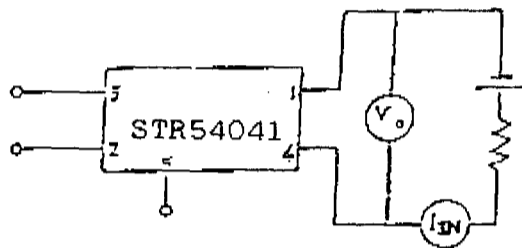

Measurement Circuit 2

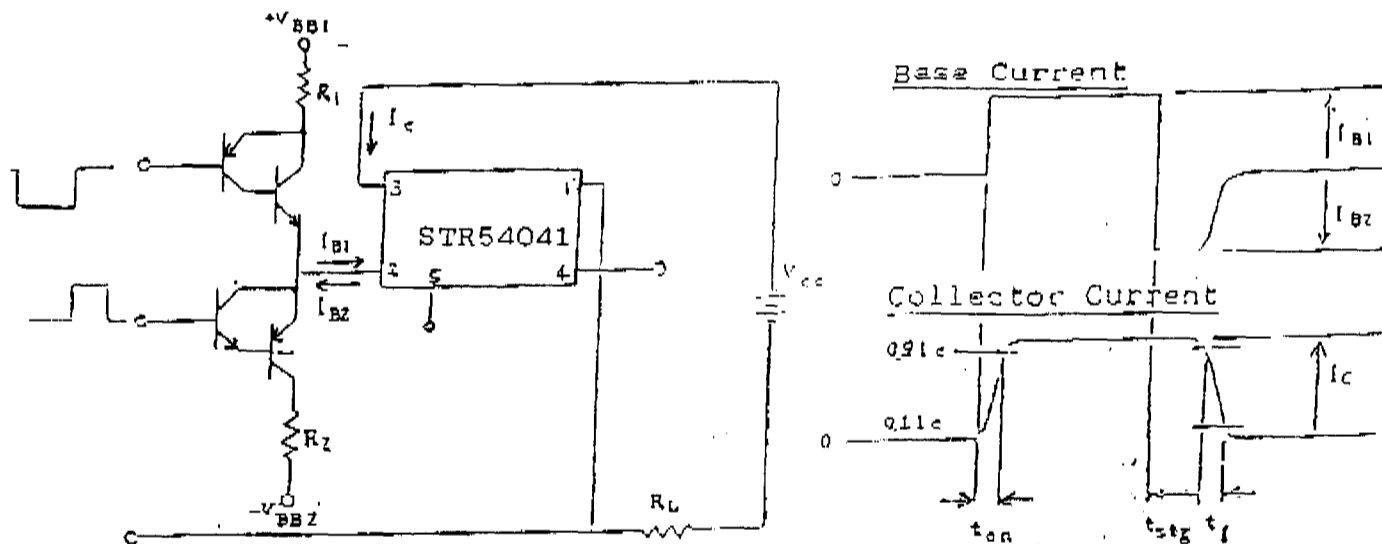

$I_c = 2A$, $R_L = 50\Omega$
 $I_{BI} = 300mA$, $I_{BZ} = 1.0A$

7. Electrical Characteristics 2

Description	Conditions	Ratings
Output Voltage	$V_{IN} = 220V$, $I_o = 0.5A$ Actual Working Circuit 1.	$114.5 \pm 1.5V$
Line Regulation	$V_{IN} = 180 \sim 280V$, $I_o = 0.5A$ Actual Working Circuit 1	Initial Value $\pm 1V$
Load Regulation	$V_{IN} = 220V$, $I_o = 0.3A \sim 0.5A$ Actual Working Circuit 1.	Initial Value $\pm 2V$

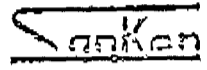

SANKEN ELECTRIC COMPANY, LTD.

Actual Working Circuit 1.
(Reference Circuit Diagram)

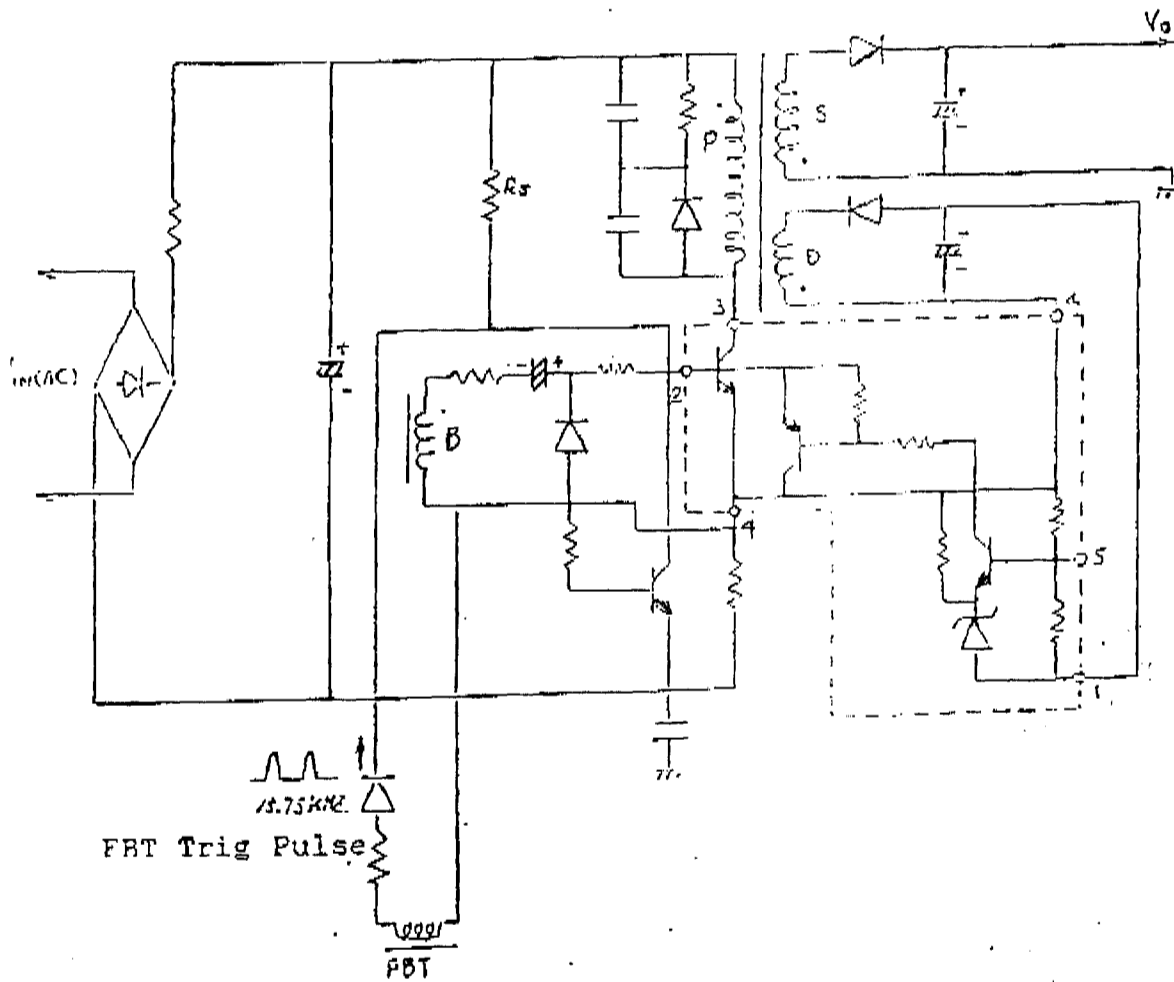

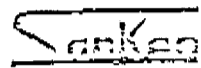

SANKEN ELECTRIC COMPANY, LTD.

Figure 1.

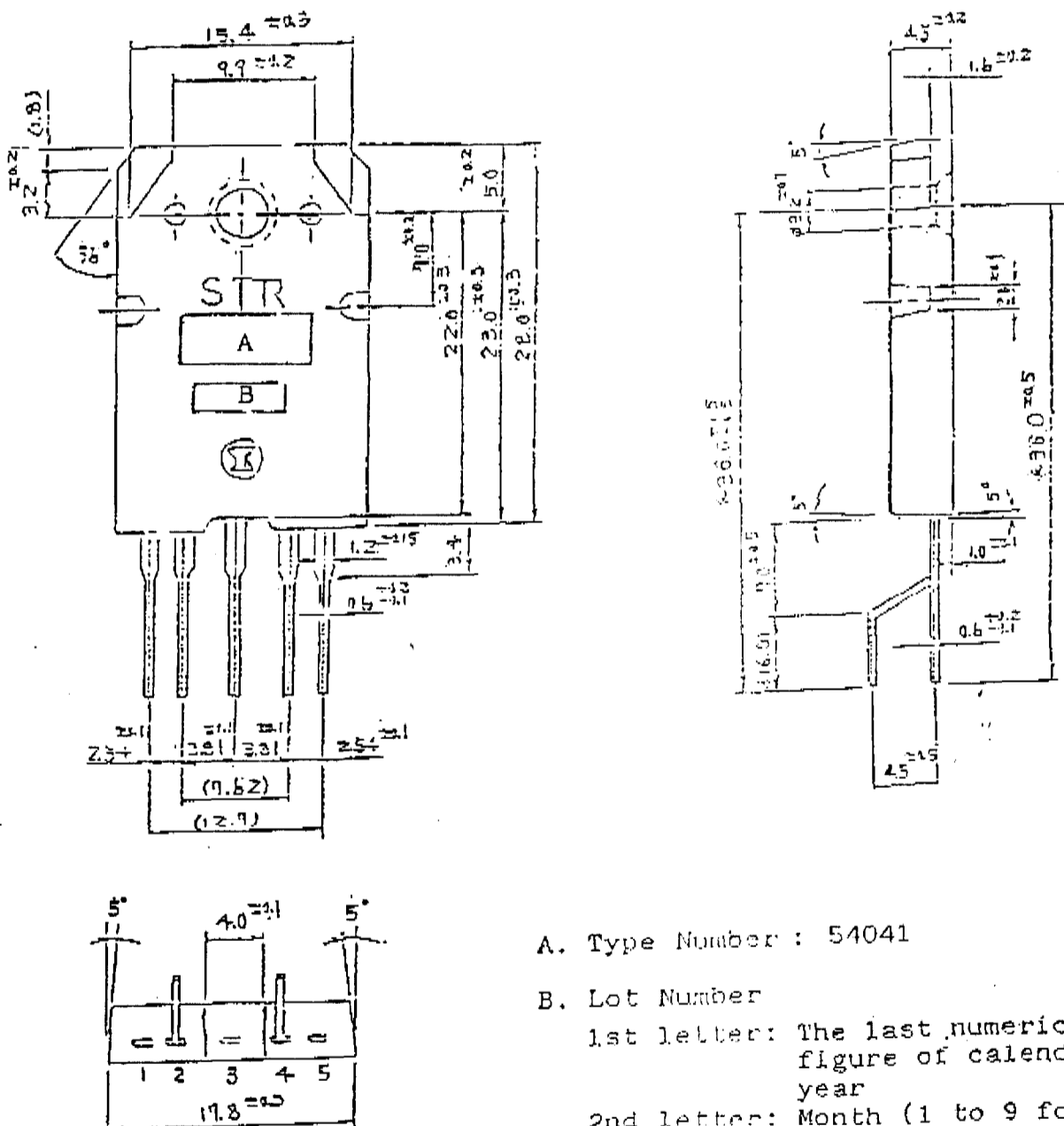

- A. Type Number : 54041
- B. Lot Number
 - 1st letter: The last numerical figure of calendar year
 - 2nd letter: Month (1 to 9 for Jan to Sep., 0 for Oct., N for Nov., D for Dec.)
 - 3rd, 4th letter: Date

- 1. Vout SENSE (-)
- 2. BASE DRIVE
- 3. IN PUT
- 4. EARTH