

UNIDIRECTIONAL TRANSIENT VOLTAGE SUPPRESSORS

- HIGH SURGE CAPABILITY :
1.5 kW/1 ms EXPO
- VERY FAST CLAMPING TIME : 1 ps
- LARGE VOLTAGE RANGE :
8.9 V → 171 V

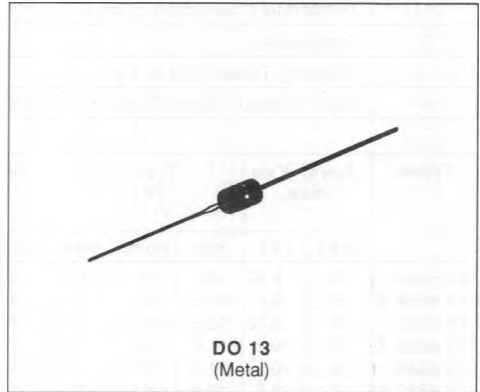

DESCRIPTION

Transient voltage suppressor diodes especially useful in protecting integrated circuits. MOS, hybrids and other voltage-sensitive semiconductors and components.

ABSOLUTE RATINGS (limiting values)

Symbol	Parameter	Value	Unit
P_p	Peak Pulse Power for 1 ms Exponential Pulse T_j Initial = 25 °C See note 1	1500	W
P	Power Dissipation on Infinite Heatsink $T_{amb} = 75$ °C	5	W
I_{FSM}	Non Repetitive Surge Peak Forward Current T_j Initial = 25 °C $t = 10$ ms	250	A
T_{stg} T_j	Storage and Junction Temperature Range	- 65 to 175 175	°C °C
T_L	Maximum Lead Temperature for Soldering During 10 s at 4 mm from Case	230	°C

THERMAL RESISTANCE

Symbol	Parameter	Value	Unit
$R_{th(j-l)}$	Junction-leads on Infinite Heatsink for $L_{lead} = 10$ mm	20	°C/W

Note : 1. For surges upper than the maximum values, the diode will present a short-circuit anode-cathode.

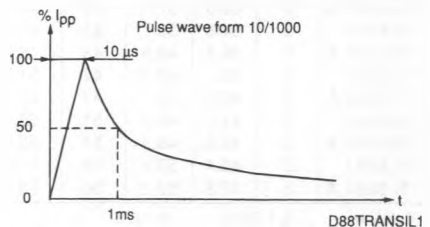

ELECTRICAL CHARACTERISTICS ($T_j = 25^\circ\text{C}$)

Symbol	Parameter	Value
V_{RM}	Stand-off Voltage	See table
$V_{(BR)}$	Breakdown Voltage	
$V_{(CL)}$	Clamping Voltage	
I_{PP}	Peak Pulse Current	
α_T	Temperature Coefficient of $V_{(BR)}$	
C	Capacitance	
$t_{clamping}$	Clamping Time (0 volt to $V_{(BR)}$)	1 ps max.
V_F	Peak Forward Voltage Drop ($I_{FM} = 100\text{ A}$)	3.5 V max.

Types	$I_{RM} @ V_{RM}$ max.		$V_{(BR)}^* @$ (V)			I_R	$V_{(CL)} @ I_{PP}$ max. 1 ms expo.		$V_{CL} @ I_{PP}$ max. 8-20 μs expo.		α_T max.	C typ. $V_R = 0$ f = 1 MHz
	(μA)	(V)	min.	nom.	max.	(mA)	(V)	(A)	(V)	(A)	($10^{-4}/^\circ\text{C}$)	(pF)
1N 5634	5	8.92	9.9	11	12.1	1	16.2	93	21.2	849	7.5	6400
1N 5634 A	5	9.4	10.5	11	11.6	1	15.6	96	20.3	887	7.5	6400
1N 5635	5	9.72	10.8	12	13.2	1	17.3	87	22.7	793	7.8	6000
1N 5635 A	5	10.2	11.4	12	12.6	1	16.7	90	21.7	829	7.8	6000
1N 5636	5	10.5	11.7	13	14.3	1	19	79	24.6	732	8.1	5500
1N 5636 A	5	11.1	12.4	13	13.7	1	18.2	82	23.6	763	8.1	5500
1N 5637	5	12.1	13.5	15	16.5	1	22	68	28.4	634	8.4	5000
1N 5637 A	5	12.8	14.3	15	15.8	1	21.2	71	27.2	662	8.4	5000
1N 5638	5	12.9	14.4	16	17.6	1	23.5	64	30.3	594	8.6	4700
1N 5638 A	5	13.6	15.2	16	16.8	1	22.5	67	28.9	623	8.6	4700
1N 5639	5	14.5	16.2	18	19.8	1	26.5	56.5	34	529	8.8	4300
1N 5639 A	5	15.3	17.1	18	18.9	1	25.2	59.5	32.5	554	8.8	4300
1N 5640	5	16.2	18	20	22	1	29.1	51.5	37.8	476	9	4000
1N 5640 A	5	17.1	19	20	21	1	27.7	54	36.1	498	9	4000
1N 5641	5	17.8	19.8	22	24.2	1	31.9	47	41.2	437	9.2	3700
1N 5641 A	5	18.8	20.9	22	23.1	1	30.6	49	39.3	458	9.2	3700
1N 5642	5	19.4	21.6	24	26.4	1	34.7	43	44.9	401	9.4	3500
1N 5642 A	5	20.5	22.8	24	25.2	1	33.2	45	42.8	421	9.4	3500
1N 5643	5	21.8	24.3	27	29.7	1	39.1	38.5	50.5	356	9.6	3200
1N 5643 A	5	23.1	25.7	27	28.4	1	37.5	40	48.3	373	9.6	3200
1N 5644	5	24.3	27	30	33	1	43.5	34.5	56.1	321	9.7	2900
1N 5644 A	5	25.6	28.5	30	31.5	1	41.4	36	53.5	336	9.7	2900
1N 5645	5	26.8	29.7	33	36.3	1	47.7	31.5	61.7	292	9.8	2700
1N 5645 A	5	28.2	31.4	33	34.7	1	45.7	33	59	305	9.8	2700
1N 5646	5	29.1	32.4	36	39.6	1	52	29	67.3	267	9.9	2500
1N 5646 A	5	30.8	34.2	36	37.8	1	49.9	30	64.3	280	9.9	2500
1N 5647	5	31.6	35.1	39	42.9	1	56.4	26.5	73	246	10	2400
1N 5647 A	5	33.3	37.1	39	41	1	53.9	28	69.7	258	10	2400
1N 5648	5	34.8	38.7	43	47.3	1	61.9	24	80.4	224	10.1	2200
1N 5648 A	5	36.8	40.9	43	45.2	1	59.3	25.3	76.8	234	10.1	2200
1N 5649	5	38.1	42.3	47	51.7	1	67.8	22.2	88	204	10.1	2050
1N 5649 A	5	40.2	44.7	47	49.4	1	64.8	23.2	84	214	10.1	2050
1N 5650	5	41.3	45.9	51	56.1	1	73.5	20.4	95.5	188	10.2	1950
1N 5650 A	5	43.6	48.5	51	53.6	1	70.1	21.4	91	198	10.2	1950
1N 5651	5	45.4	50.4	56	61.6	1	80.5	18.6	105	171	10.3	1800
1N 5651 A	5	47.8	53.2	56	58.8	1	77	19.5	100	180	10.3	1800

* Pulse test $t_p < 50\text{ms}$ $\delta < 2\%$.

(continued)

Types	I_{RM} @ V_{RM} max.		$V_{(BR)}^*$ @ (V)			I_R	$V_{(CL)}$ @ I_{PP} max. 1 ms expo.		V_{CL} @ I_{PP} max. 8-20 μ s expo.		α_T max.	C typ. $V_R = 0$ $f = 1$ MHz
	(μ A)	(V)	min.	nom.	max.	(mA)	(V)	(A)	(V)	(A)	($10^{-4}/^{\circ}$ C)	(pF)
1N 5652	5	50.2	55.8	62	68.2	1	89	16.9	116	155	10.4	1700
1N 5652 A	5	53	58.9	62	65.1	1	85	17.7	111	162	10.4	1700
1N 5653	5	55.1	61.2	68	74.8	1	98	15.3	127	142	10.4	1550
1N 5653 A	5	58.1	64.6	68	71.4	1	92	16.3	121	148	10.4	1550
1N 5654	5	60.7	67.5	75	82.5	1	108	13.9	140	128	10.5	1450
1N 5654 A	5	64.1	71.3	75	78.8	1	103	14.6	134	134	10.5	1450
1N 5655	5	66.4	73.8	82	90.2	1	118	12.7	153	117	10.5	1350
1N 5655 A	5	70.1	77.9	82	86.1	1	113	13.3	146	123	10.5	1350
1N 5656	5	73.7	81.9	91	100	1	131	11.4	170	106	10.6	1250
1N 5656 A	5	77.8	86.5	91	95.5	1	125	12	162	111	10.6	1250
1N 5657	5	81	90	100	110	1	144	10.4	187	96	10.6	1150
1N 5657 A	5	85.5	95	100	105	1	137	11	178	101	10.6	1150
1N 5658	5	89.2	99	110	121	1	158	9.5	203	89	10.7	1050
1N 5658 A	5	94	105	110	116	1	152	9.9	195	92	10.7	1050
1N 5659	5	97.2	108	120	132	1	173	8.7	222	81	10.7	1000
1N 5659 A	5	102	114	120	126	1	165	9.1	212	85	10.7	1000
1N 5660	5	105	117	130	143	1	187	8	240	75	10.7	950
1N 5660 A	5	111	124	130	137	1	179	8.4	230	78	10.7	950
1N 5661	5	121	135	150	165	1	215	7	277	65	10.8	850
1N 5661 A	5	128	143	150	158	1	207	7.2	265	68	10.8	850
1N 5662	5	130	144	160	176	1	230	6.5	296	61	10.8	800
1N 5662 A	5	136	152	160	168	1	219	6.8	282	64	10.8	800
1N 5663	5	138	153	170	187	1	244	6.2	314	57.5	10.8	750
1N 5663 A	5	145	161	170	179	1	234	6.4	301	60	10.8	750
1N 5664	5	146	162	180	198	1	258	5.8	333	54	10.8	725
1N 5664 A	5	154	171	180	189	1	246	6.1	317	57	10.8	725
1N 5665	5	162	180	200	220	1	287	5.2	370	48.5	10.8	675
1N 5665 A	5	171	190	200	210	1	274	5.5	353	51	10.8	675

* Pulse test

 $t_p < 50$ ms $\delta < 2\%$.



Fig.1 - Peak pulse power versus exponential pulse duration.



Fig.2 - Clamping voltage versus peak pulse current.
 exponential waveform $t = 20 \mu s$
 $t = 1 ms$ - - - -
 $t = 10 ms$ ———

Note : The curves of the figure 2 are specified for a junction temperature of 25 °C before surge. The given results may be extrapolated for other junction temperatures by using the following formula : $\Delta V (BR) = \alpha_T (V(BR)) \times [T_j - 25] \times V (BR)$
 For intermediate voltages, extrapolate the given results.

0891N5634A4



Fig. 3 - Allowable power dissipation versus junction temperature.

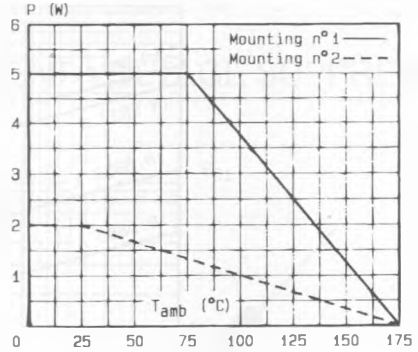

Fig. 4 - Power dissipation versus ambient temperature.

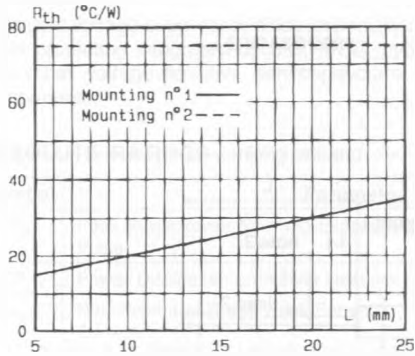

Fig. 5 - Thermal resistance versus lead length.

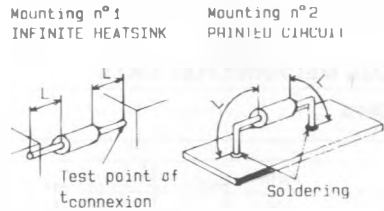

Fig. 6 - Transient thermal impedance junction-ambient for mounting n°2 versus pulse duration (L = 10 mm).

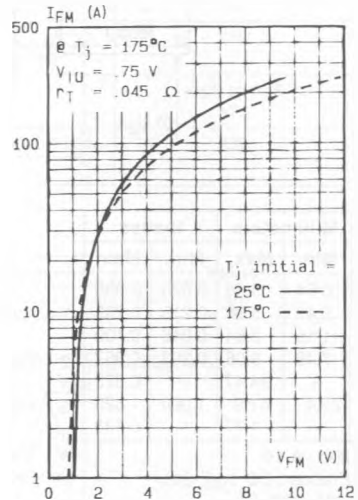

Fig. 7 - Peak forward current versus peak forward voltage drop (typical values for unidirectional types).

DB91N5634AP5

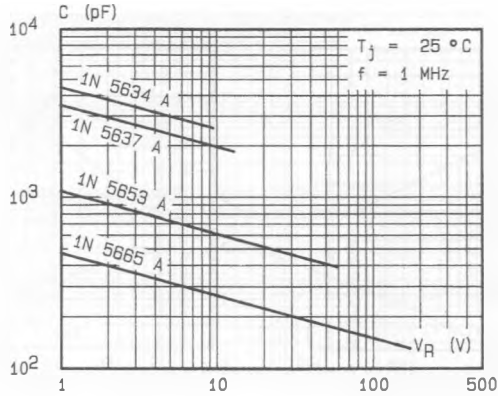
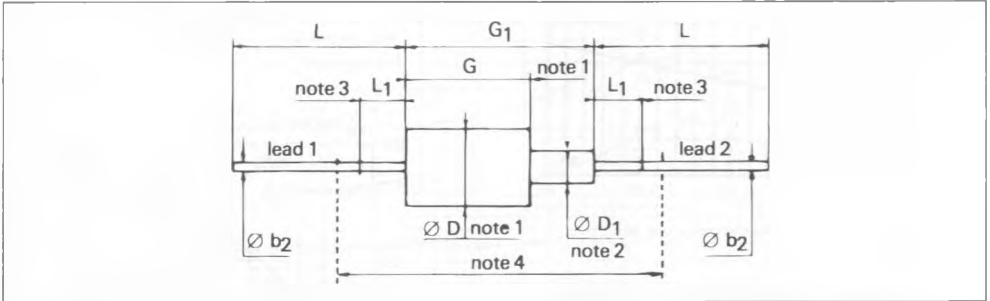

Fig.8 - Capacitance versus reverse applied voltage (typical values).

D891N5634AP6

PACKAGE MECHANICAL DATA

DO 13 Metal



Ref.	Millimeters		Inches		Notes
	Min.	Max.	Min.	Max.	
Ø b ₂	0.64	0.88	0.025	0.035	1 - Ø D is substantially constant along the length G. 2 - This dimension limits any pinch or seal deformation along the tubulation. 3 - The lead diameter Ø b ₂ is not controlled over zone L ₁ . 4 - The minimum axial length within which the device may be placed with its leads bent at right angles is 1.00" (25.4 mm).
Ø D	5.47	5.96	0.215	0.235	
Ø D ₁	1.15	2.54	0.045	0.100	
G	7.45	9.06	0.293	0.357	
G ₁	—	14.47	—	0.570	
L	25.4	41.2	1.000	1.625	
L ₁	—	4.77	—	0.188	
Code IEC : A 19 Code France : DO 13/F 61 Code USA : DO 13					

Cooling method : by convection (method A).
 Marking : type number.
 Weight : 1.5 g.
 Lead 1 connected electrically to case.