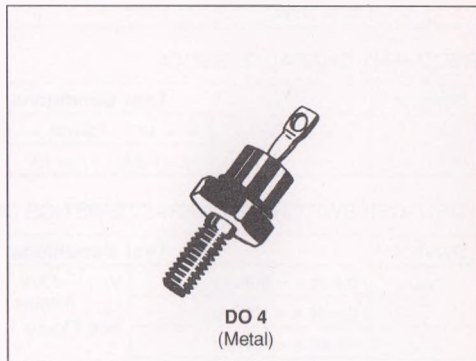

FAST RECOVERY RECTIFIER DIODES

- VERY LOW REVERSE RECOVERY TIME
- VERY LOW SWITCHING LOSSES
- LOW NOISE TURN-OFF SWITCHING

SUITABLE APPLICATIONS :

- FREE WHEELING DIODE IN CONVERTERS AND MOTOR CONTROL CIRCUITS
- RECTIFIER IN S.M.P.S.

ABSOLUTE RATINGS (limiting values)

Symbol	Parameter	Value	Unit	
I_{FRM}	Repetitive Peak Forward Current	$t_p \leq 10\mu s$	200	A
$I_{F(RMS)}$	RMS Forward Current		25	A
$I_{F(AV)}$	Average Forward Current	$T_{case} = 100^\circ C$ $\delta = 0.5$	12	A
I_{FSM}	Surge non Repetitive Forward Current	$t_p = 10ms$ sinusoidal	200	A
P	Power Dissipation	$T_{case} = 100^\circ C$	20	W
T_{stg} T_j	Storage and Junction Temperature Range		- 40 to + 150	$^\circ C$

Symbol	Parameter	BYT 12-			Unit
		200	300	400	
V_{RRM}	Repetitive Peak Reverse Voltage	200	300	400	V
V_{RSM}	Non Repetitive Peak Reverse Voltage	220	330	440	V

THERMAL RESISTANCE

Symbol	Test Conditions	Value	Unit
$R_{th(j-c)}$	Junction-case	2.5	$^\circ C/W$

ELECTRICAL CHARACTERISTICS

STATIC CHARACTERISTICS

Symbol	Test Conditions		Min.	Typ.	Max.	Unit
I _R	T _j = 25°C	V _R = V _{RRM}			15	μA
	T _j = 100°C				2.5	mA
V _F	T _j = 25°C	I _F = 12A			1.5	V
	T _j = 100°C				1.4	

RECOVERY CHARACTERISTICS

Symbol	Test Conditions		Min.	Typ.	Max.	Unit
t _{rr}	T _j = 25°C	I _F = 1A di _F /dt = - 15A/μs** V _R = 30V			100	ns
		I _F = 0.5A I _R = 1A I _{rr} = 0.25A			50	

TURN - OFF SWITCHING CHARACTERISTICS (Without Series Inductance)

Symbol	Test Conditions		Min.	Typ.	Max.	Unit
I _{IRM}	di _F /dt = - 50A/μs	V _{CC} = 200V I _F = 12A L _p ≤ 0.05μH T _j = 100°C See Figure 11			75	ns
	di _F /dt = - 100A/μs			50		
I _{RM}	di _F /dt = - 50A/μs				3.8	A
	di _F /dt = - 100A/μs			4.3		

TURN - OFF OVERVOLTAGE COEFFICIENT (With Series Inductance)

Symbol	Test Conditions		Min.	Typ.	Max.	Unit
C = $\frac{V_{RP}}{V_{CC}}$	T _j = 100°C di _F /dt = - 12A/μs	V _{CC} = 120V I _F = I _{F(AV)} See note L _p = 7μH See Figure 12		3.3		

Note : Applicable to BYT12-400 only

To evaluate the conduction losses use the following equations :

$$V_F = 1.1 + 0.022 I_F \qquad P = 1.1 \times I_{F(AV)} + 0.022 I_F^2_{(RMS)}$$

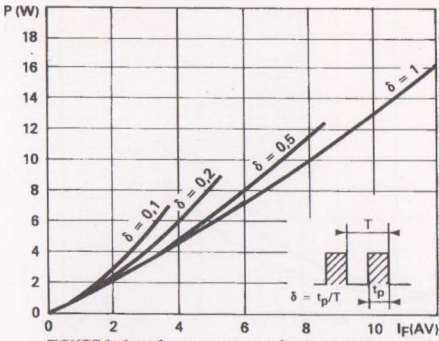

FIGURE 1 : Low frequency power losses versus average current.

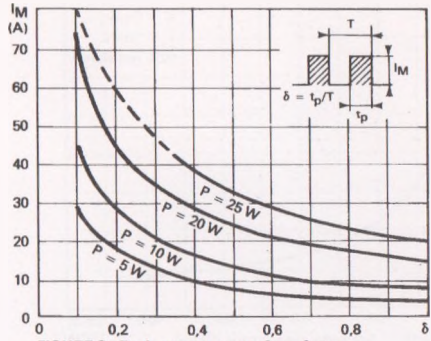

FIGURE 2 : Peak current versus form factor.

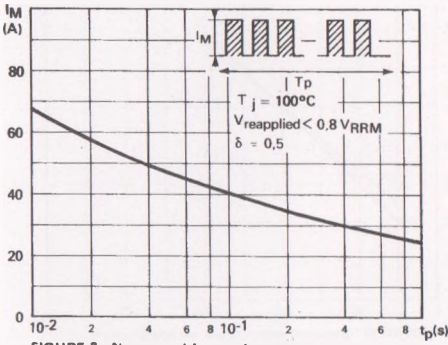

FIGURE 3 : Non repetitive peak surge current versus overload duration.

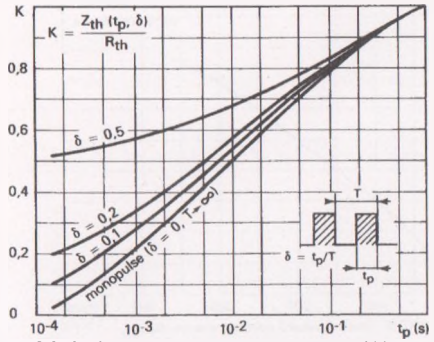

FIGURE 4 : Thermal impedance versus pulse width.

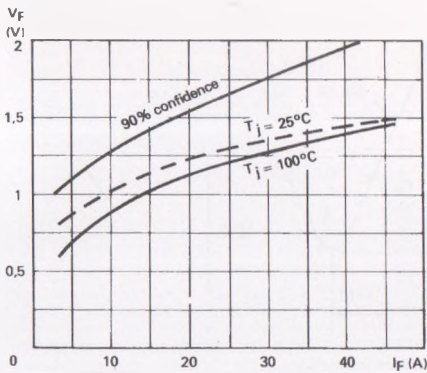

FIGURE 5 : Voltage drop versus forward current.

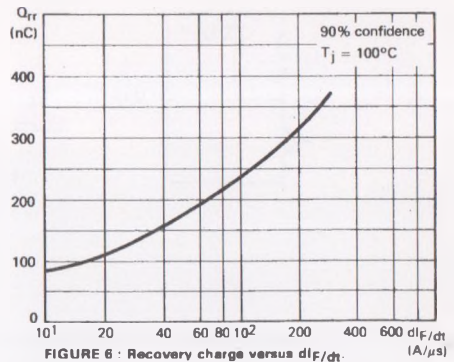

FIGURE 6 : Recovery charge versus dI_F/dt .

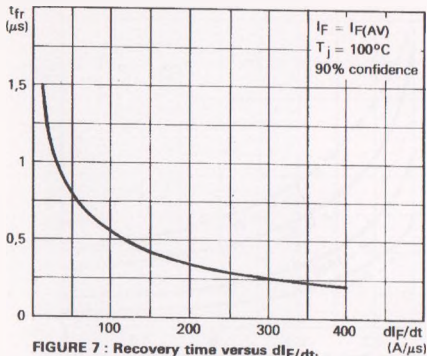

FIGURE 7 : Recovery time versus dI_F/dt .

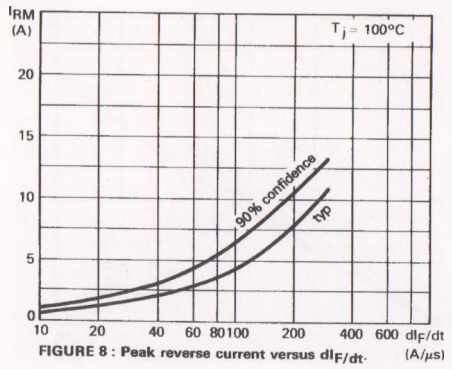

FIGURE 8 : Peak reverse current versus dI_F/dt .

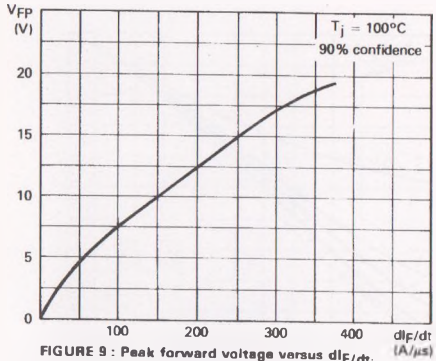

FIGURE 9 : Peak forward voltage versus dI_F/dt .

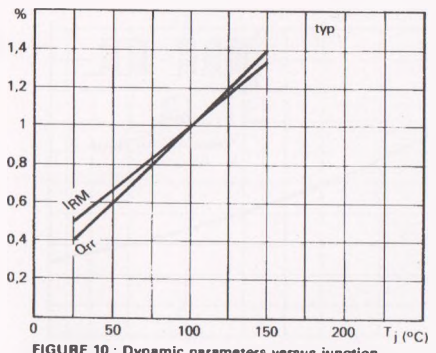

FIGURE 10 : Dynamic parameters versus junction temperature.

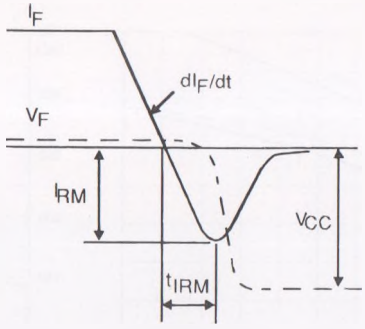
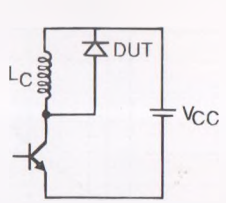

Figure 11 : Turn-off switching characteristics (without series inductance).

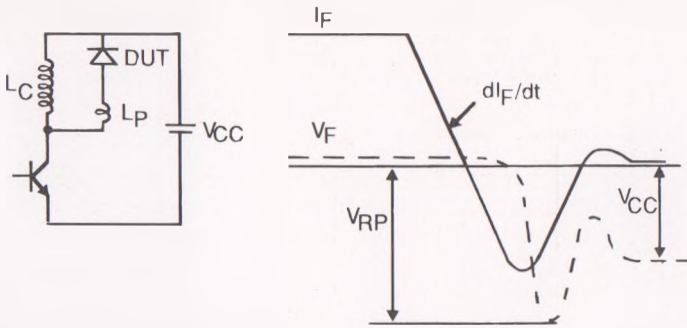

Figure 12 : Turn-off switching characteristics (with series inductance).