

**FAST RECOVERY RECTIFIER DIODES**

**FEATURES**

- VERY LOW REVERSE RECOVERY TIME
- VERY LOW SWITCHING LOSSES
- LOW NOISE TURN-OFF SWITCHING
- INSULATED PACKAGE :  
Insulating voltage = 2500 V<sub>RMS</sub>  
Capacitance = 45 pF

**DESCRIPTION**

Dual high voltage rectifiers ranging from 200V to 400V suited for Switch Mode Power Supplies and other power converters.  
The devices are packaged in ISOTOP.

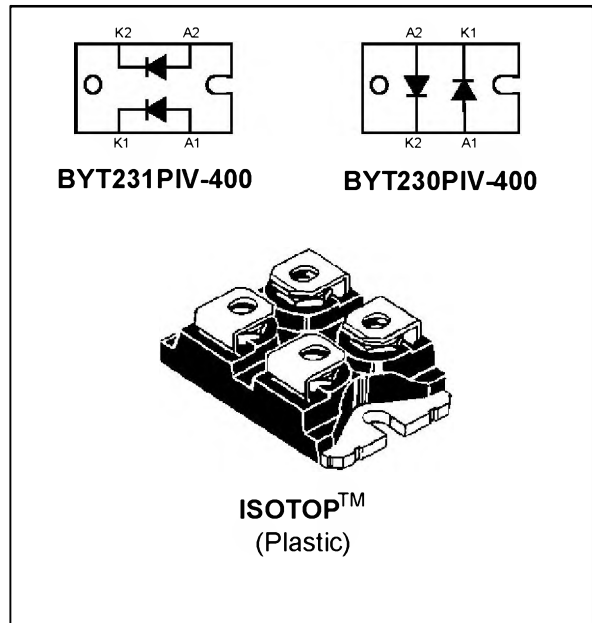

**ABSOLUTE MAXIMUM RATINGS**

Symbol	Parameter		Value	Unit
I <sub>FRM</sub>	Repetitive peak forward current	tp ≤ 10μs	500	A
I <sub>F(RMS)</sub>	RMS forward current	Per diode	50	A
I <sub>F(AV)</sub>	Average forward current	T <sub>C</sub> =75°C δ = 0.5 Per diode	30	A
I <sub>FSM</sub>	Surge non repetitive forward current	tp=10ms sinusoidal Per diode	350	A
T <sub>stg</sub> T <sub>J</sub>	Storage and junction temperature range		- 40 to + 150 - 40 to + 150	°C °C

Symbol	Parameter	BYT230PIV- / BYT231PIV-			Unit
		200	300	400	
V <sub>RRM</sub>	Repetitive peak reverse voltage	200	300	400	V

TM : ISOTOP is a trademark of SGS-THOMSON Microelectronics.

## BYT230PIV-400 / BYT231PIV-400

### THERMAL RESISTANCE

Symbol	Parameter		Value	Unit
Rth (j-c)	Junction to case	Per diode	1.5	°C/W
		Total	0.8	
Rth (c)	Coupling		0.1	°C/W

When the diodes 1 and 2 are used simultaneously :  
 $\Delta T_j(\text{diode 1}) = P(\text{diode 1}) \times R_{th}(\text{Per diode}) + P(\text{diode 2}) \times R_{th}(c)$

### ELECTRICAL CHARACTERISTICS (Per diode) STATIC CHARACTERISTICS

Symbol	Test Conditions		Min.	Typ.	Max.	Unit
$V_F$ *	$T_j = 25^\circ\text{C}$	$I_F = 30\text{ A}$			1.5	V
	$T_j = 100^\circ\text{C}$				1.4	
$I_R$ **	$T_j = 25^\circ\text{C}$	$V_R = V_{RRM}$			35	$\mu\text{A}$
	$T_j = 100^\circ\text{C}$				6	mA

Pulse test : \*  $t_p = 380\ \mu\text{s}$ , duty cycle < 2 %

\*\*  $t_p = 5\ \text{ms}$ , duty cycle < 2 %

### RECOVERY CHARACTERISTICS

Symbol	Test Conditions		Min.	Typ.	Max.	Unit
trr	$T_j = 25^\circ\text{C}$	$I_F = 0.5\text{ A}$ $I_{rr} = 0.25\text{ A}$ $I_R = 1\text{ A}$			50	ns
		$I_F = 1\text{ A}$ $dI_F/dt = -15\text{ A}/\mu\text{s}$ $V_R = 30\text{ V}$			100	

### TURN-OFF SWITCHING CHARACTERISTICS (Without serie inductance)

Symbol	Test Conditions		Min.	Typ.	Max.	Unit
$t_{IRM}$	$dI_F/dt = -120\text{ A}/\mu\text{s}$	$V_{CC} = 200\text{ V}$ $I_F = 30\text{ A}$ $L_p \leq 0.05\ \mu\text{H}$ $T_j = 100^\circ\text{C}$ see fig. 11			75	ns
	$dI_F/dt = -240\text{ A}/\mu\text{s}$			50		
$I_{RM}$	$dI_F/dt = -120\text{ A}/\mu\text{s}$				9	A
	$dI_F/dt = -240\text{ A}/\mu\text{s}$			12		

### TURN-OFF OVERVOLTAGE COEFFICIENT (With serie inductance)

Symbol	Test Conditions		Min.	Typ.	Max.	Unit
$C = \frac{V_{RP}}{V_{CC}}$	$T_j = 100^\circ\text{C}$ $V_{CC} = 60\text{ V}$ $I_F = I_{F(AV)}$ $dI_F/dt = -30\text{ A}/\mu\text{s}$ $L_p = 1\ \mu\text{H}$	see note see fig.12		3.3		/

Note : Applicable to BYT230PIV-400 / BYT231PIV-400 only

To evaluate the conduction losses use the following equation :

$$P = 1.1 \times I_{F(AV)} + 0.0095 \times I_F^2(\text{RMS})$$

**Fig.1 :** Low frequency power losses versus average current.

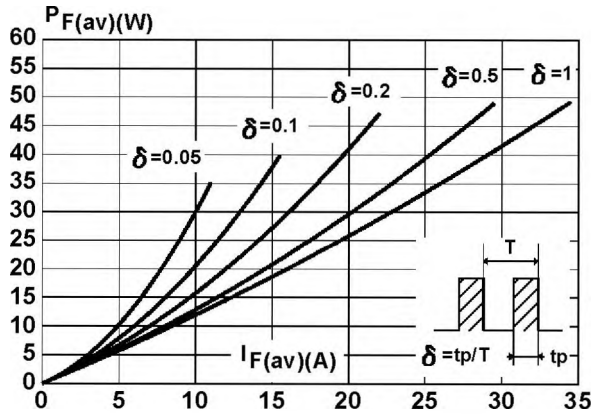

**Fig.2 :** Peak current versus form factor.

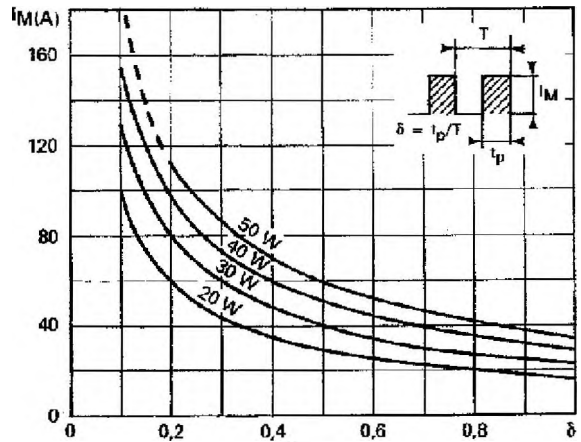

**Fig.3 :** Non repetitive peak surge current versus overload duration.

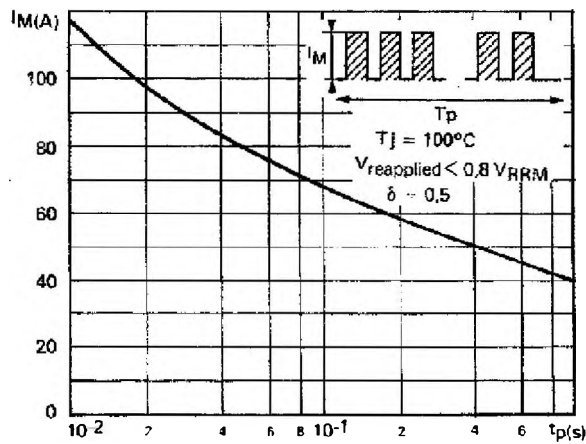

**Fig.4 :** Relative variation of thermal impedance junction to case versus pulse duration.

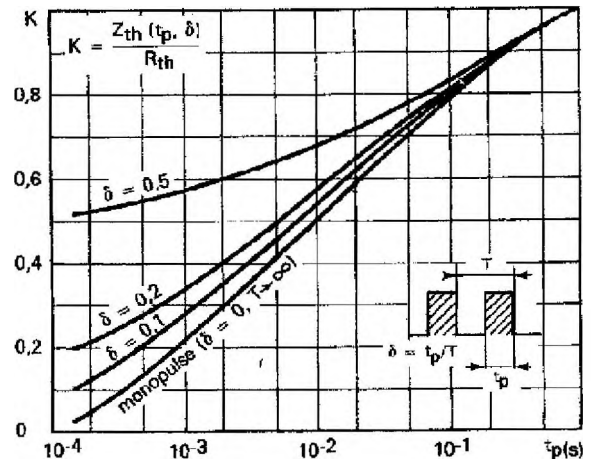

**Fig.5 :** Voltage drop versus forward current.

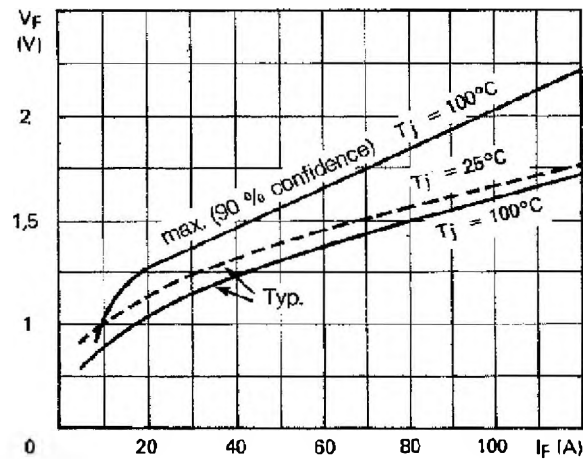

**Fig.6 :** Recovery charge versus di\_F/dt.

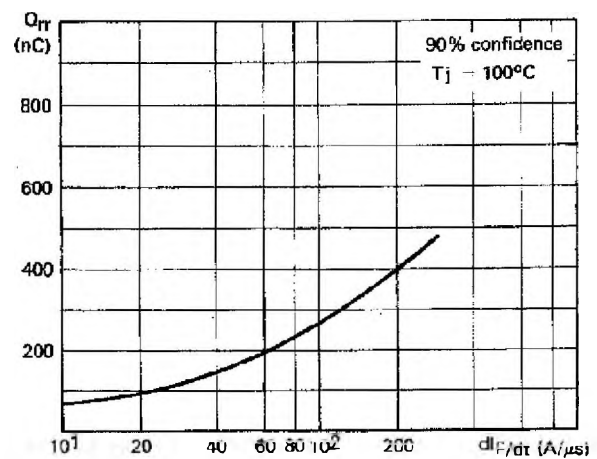

Fig.7 : Recovery time versus  $di_F/dt$ .

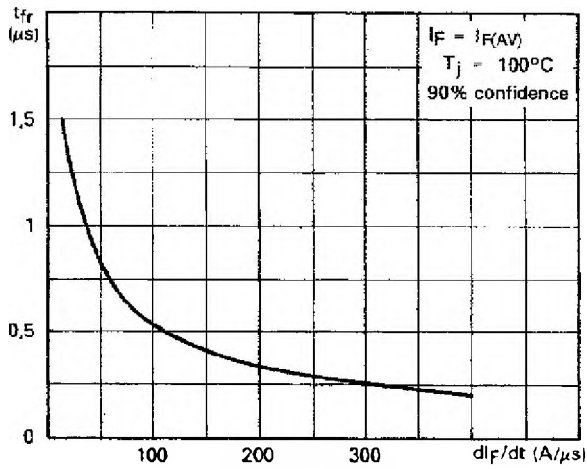

Fig.8 : Peak reverse current versus  $di_F/dt$ .

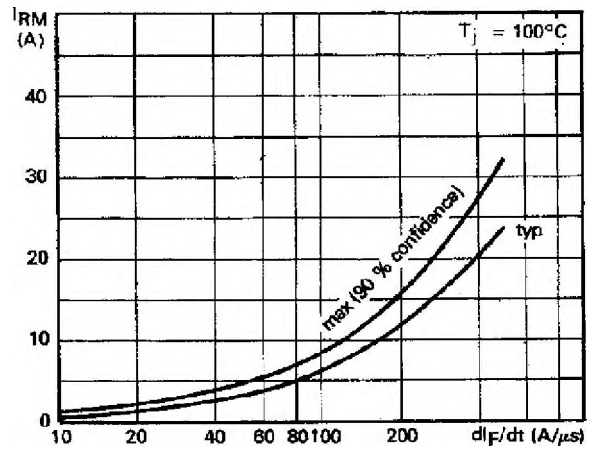

Fig.9 : Peak forward voltage versus  $di_F/dt$ .

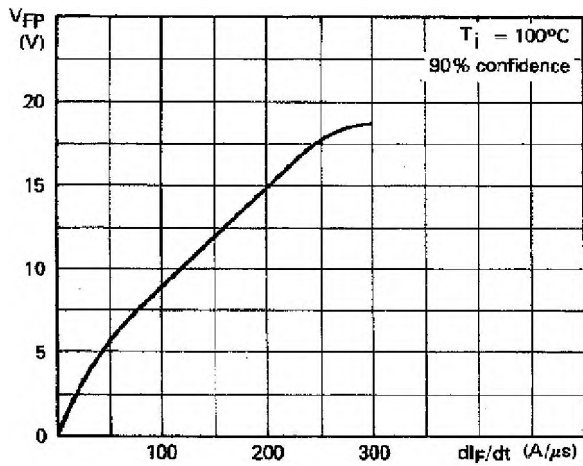

Fig.10 : Dynamic parameters versus junction temperature.

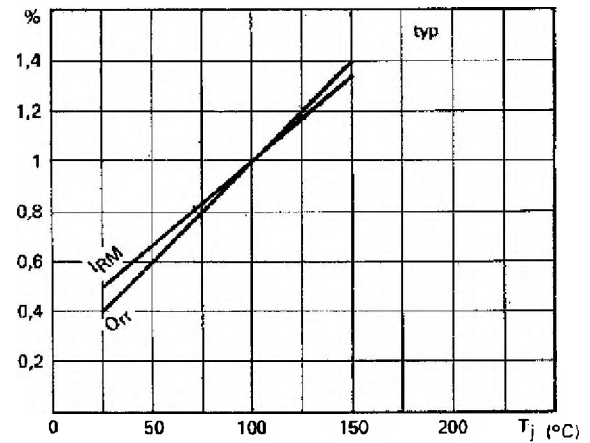

Fig.11 : TURN-OFF SWITCHING CHARACTERISTICS (Without serie inductance)

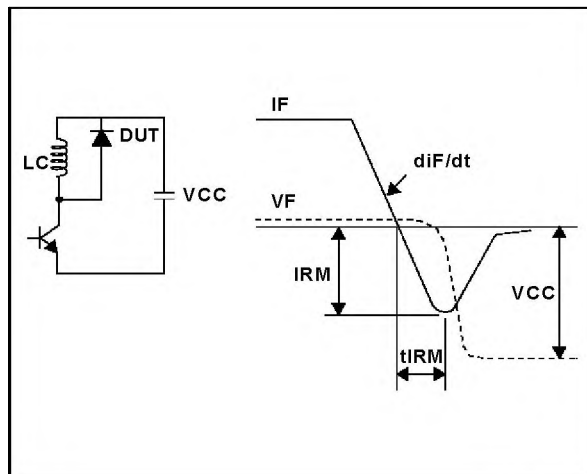
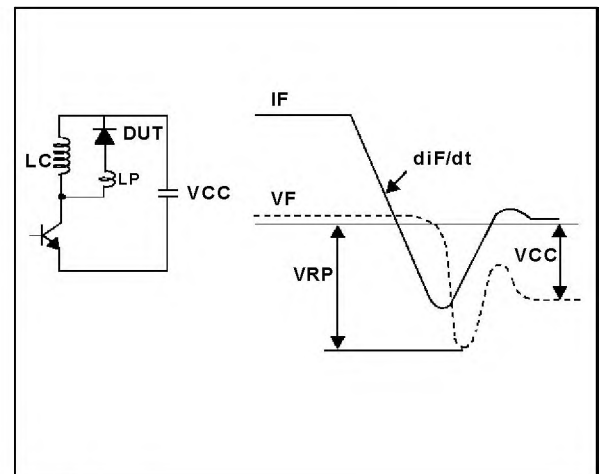
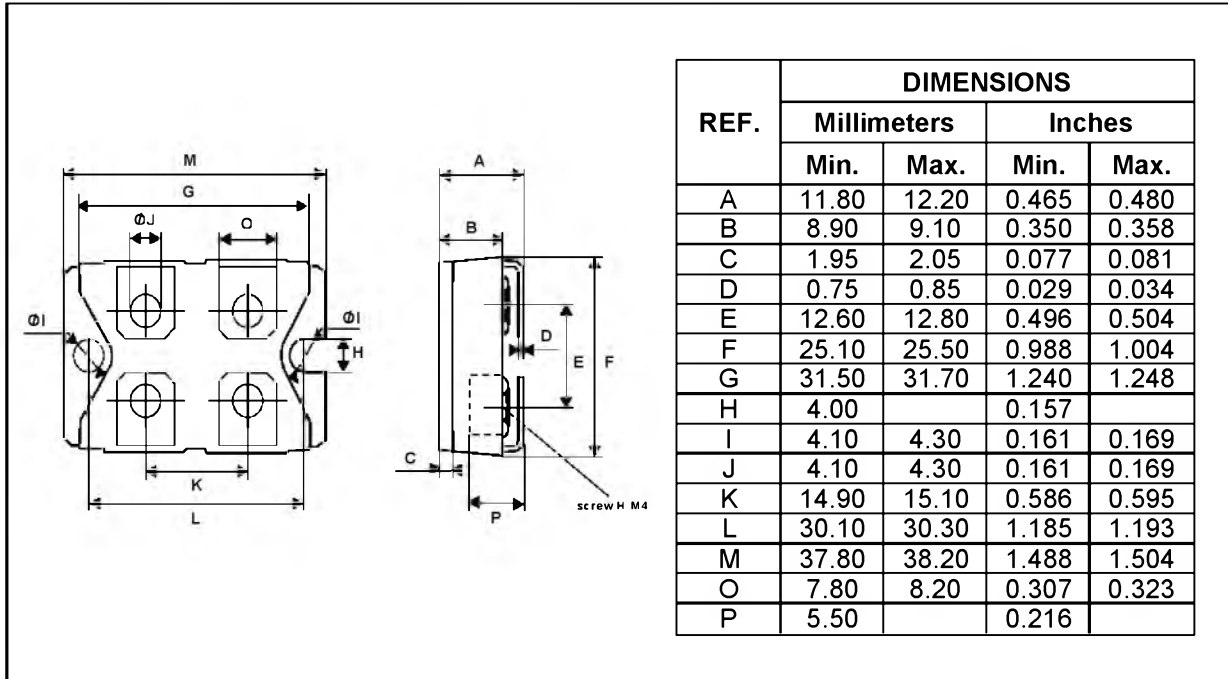

Fig.12 : TURN-OFF SWITCHING CHARACTERISTICS (With serie inductance)



**PACKAGE MECHANICAL DATA**  
ISOTOP Screw version



Cooling method : C  
 Marking : Type number  
 Weight : 28 g (without screws)  
 Electrical isolation : 2500V<sub>(RMS)</sub>  
 Capacitance : < 45 pF  
 Inductance : < 5nH

- Recommended torque value : 1.3 N.m (MAX 1.5 N.m) for the 6 x M4 screws. (2 x M4 screws recommended for mounting the package on the heatsink and the 4 screws given with the screw version).
- The screws supplied with the package are adapted for mounting on a board (or other types of terminals) with a thickness of 0.6 mm min and 2.2 mm max.

Information furnished is believed to be accurate and reliable. However, SGS-THOMSON Microelectronics assumes no responsibility for the consequences of use of such information nor for any infringement of patents or other rights of third parties which may result from its use. No license is granted by implication or otherwise under any patent or patent rights of SGS-THOMSON Microelectronics. Specifications mentioned in this publication are subject to change without notice. This publication supersedes and replaces all information previously supplied. SGS-THOMSON Microelectronics products are not authorized for use as critical components in life support devices or systems without express written approval of SGS-THOMSON Microelectronics.

© 1996 SGS-THOMSON Microelectronics - Printed in Italy - All rights reserved.

SGS-THOMSON Microelectronics GROUP OF COMPANIES  
 Australia - Brazil - Canada - China - France - Germany - Hong Kong - Italy - Japan - Korea - Malaysia - Malta - Morocco -  
 The Netherlands - Singapore - Spain - Sweden - Switzerland - Taiwan - Thailand - United Kingdom - U.S.A.