

FAST RECOVERY RECTIFIER DIODES

FEATURES

- VERY LOW REVERSE RECOVERY TIME
- VERY LOW SWITCHING LOSSES
- LOW NOISE TURN-OFF SWITCHING
- INSULATED PACKAGE :
Insulating voltage = 2500 V_{RMS}
Capacitance = 45 pF

DESCRIPTION

Dual high voltage rectifiers ranging from 400V to 200V suited for Switch Mode Power Supplies and other power converters.
The devices are packaged in ISOTOP.

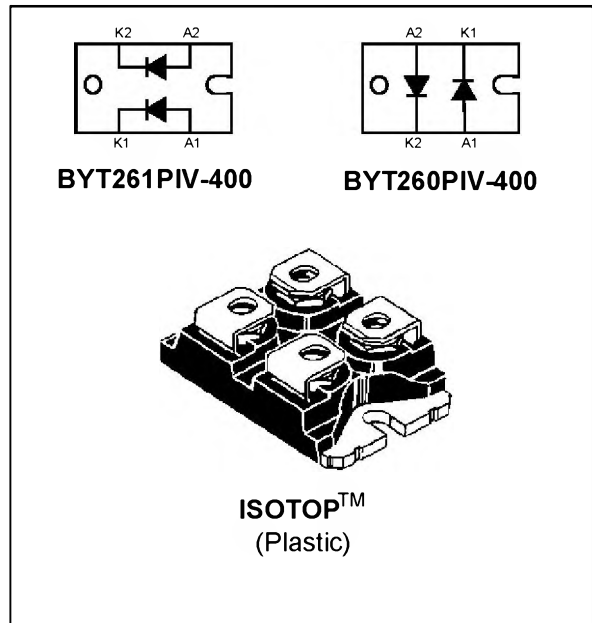

ABSOLUTE MAXIMUM RATINGS

Symbol	Parameter		Value	Unit
I _{FRM}	Repetitive peak forward current	tp ≤ 10μs	800	A
I _{F(RMS)}	RMS forward current	Per diode	140	A
I _{F(AV)}	Average forward current	T _C =80°C δ = 0.5 Per diode	60	A
I _{FSM}	Surge non repetitive forward current	tp=10ms sinusoidal Per diode	600	A
T _{stg} T _J	Storage and junction temperature range		- 40 to + 150 - 40 to + 150	°C °C

Symbol	Parameter	BYT261PIV-/BYT260PIV-			Unit
		200	300	400	
V _{RRM}	Repetitive peak reverse voltage	200	300	400	V

TM : ISOTOP is a trademark of SGS-THOMSON Microelectronics.

BYT261PIV-400

THERMAL RESISTANCE

Symbol	Parameter		Value	Unit
Rth (j-c)	Junction to case	Per diode	0.7	°C/W
		Total	0.4	
Rth (c)	Coupling		0.1	°C/W

When the diodes 1 and 2 are used simultaneously :

$$\Delta T_j(\text{diode 1}) = P(\text{diode 1}) \times R_{th}(\text{Per diode}) + P(\text{diode 2}) \times R_{th}(c)$$

ELECTRICAL CHARACTERISTICS (Per diode) STATIC CHARACTERISTICS

Symbol	Test Conditions		Min.	Typ.	Max.	Unit
V _F *	T _j = 25°C	I _F = 60 A			1.5	V
	T _j = 100°C				1.4	
I _R **	T _j = 25°C	V _R = V _{RRM}			60	μA
	T _j = 100°C				6	mA

Pulse test : * tp = 380 μs, duty cycle < 2 %

** tp = 5 ms, duty cycle < 2 %

RECOVERY CHARACTERISTICS

Symbol	Test Conditions		Min.	Typ.	Max.	Unit
trr	T _j = 25°C	I _F = 0.5A I _{rr} = 0.25A I _R = 1A			50	ns
		I _F = 1A dI _F /dt = -15A/μs V _R = 30V			100	

TURN-OFF SWITCHING CHARACTERISTICS (Without serie inductance)

Symbol	Test Conditions		Min.	Typ.	Max.	Unit
t _{IRM}	dI _F /dt = -240A/μs	V _{CC} = 200V I _F = 60A L _p ≤ 0.05μH T _j = 100°C see fig. 11			75	ns
	dI _F /dt = -480A/μs			50		
I _{RM}	dI _F /dt = -240A/μs				18	A
	dI _F /dt = -480A/μs			24		

TURN-OFF OVERVOLTAGE COEFFICIENT (With serie inductance)

Symbol	Test Conditions		Min.	Typ.	Max.	Unit
$C = \frac{V_{RP}}{V_{CC}}$	T _j = 100°C V _{CC} = 120V I _F = I _{F(AV)} dI _F /dt = -60A/μs L _p = 0.8μH	see note see fig.12		3.3	4	/

Note : Applicable to BYT261PIV-400 only

To evaluate the conduction losses use the following equation :

$$P = 1.1 \times I_{F(AV)} + 0.0045 \times I_{F(RMS)}^2$$

Fig.1 : Low frequency power losses versus average current.

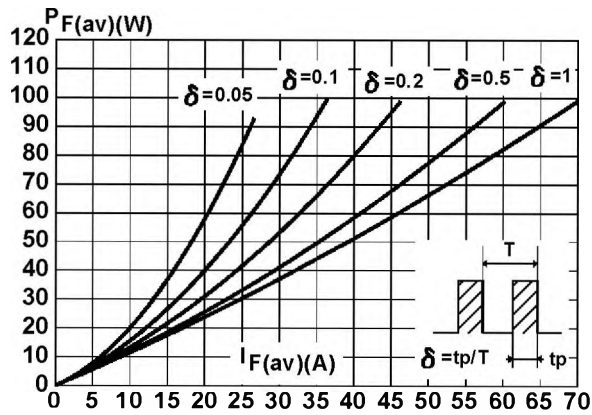

Fig.2 : Peak current versus form factor.

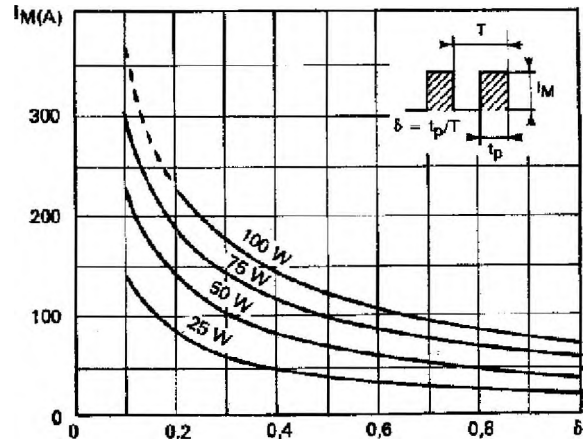

Fig.3 : Non repetitive peak surge current versus overload duration.

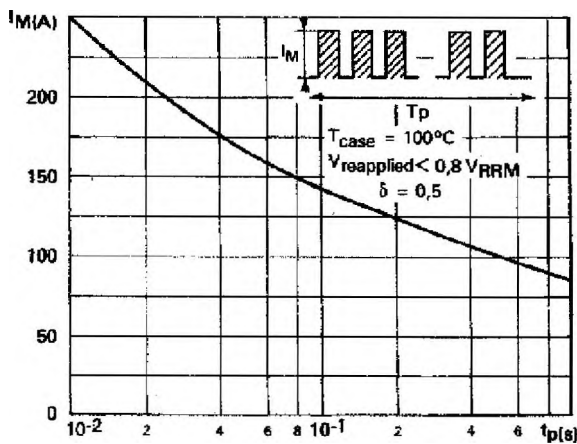

Fig.4 : Relative variation of thermal impedance junction to case versus pulse duration.

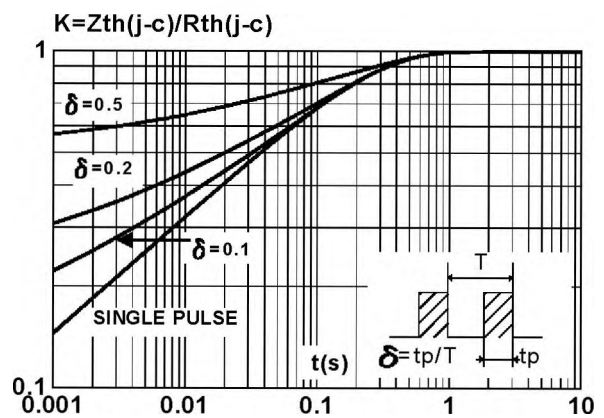

Fig.5 : Voltage drop versus forward current.

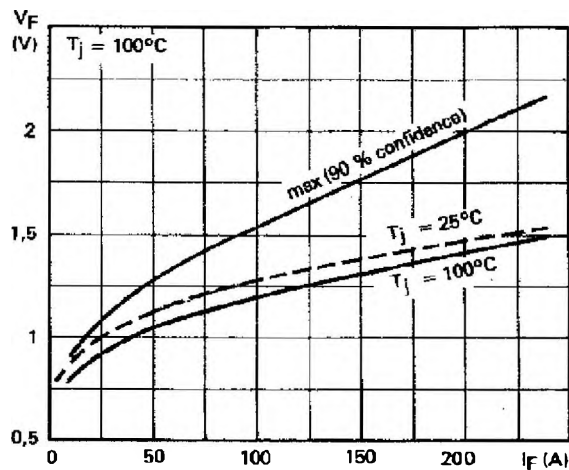

Fig.6 : Recovery charge versus diF/dt.

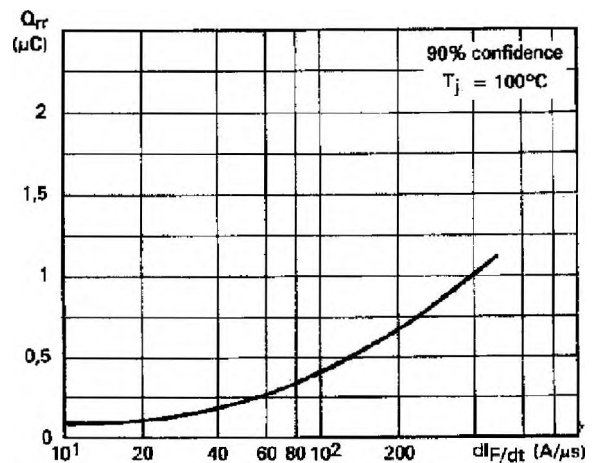

Fig.7 : Recovery time versus di_F/dt .

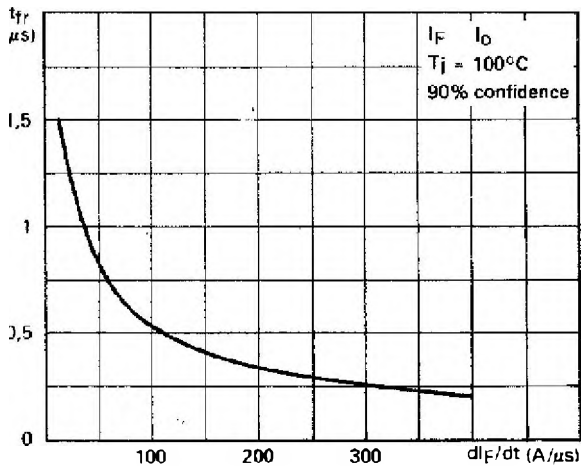

Fig.8 : Peak reverse current versus di_F/dt .

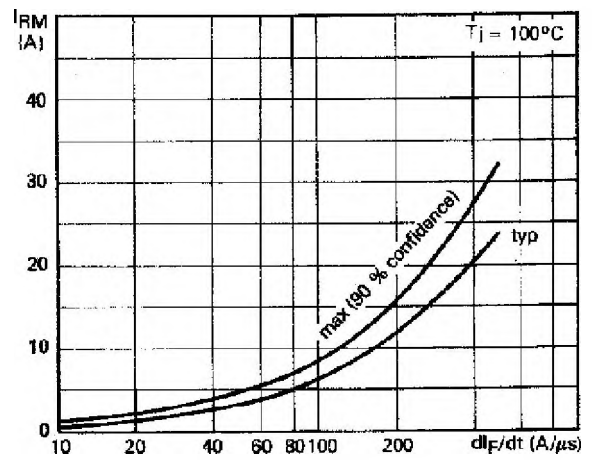

Fig.9 : Peak forward voltage versus di_F/dt .

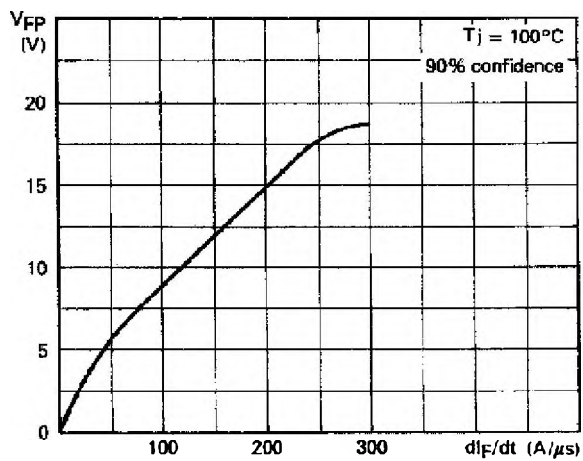

Fig.10 : Dynamic parameters versus junction temperature.

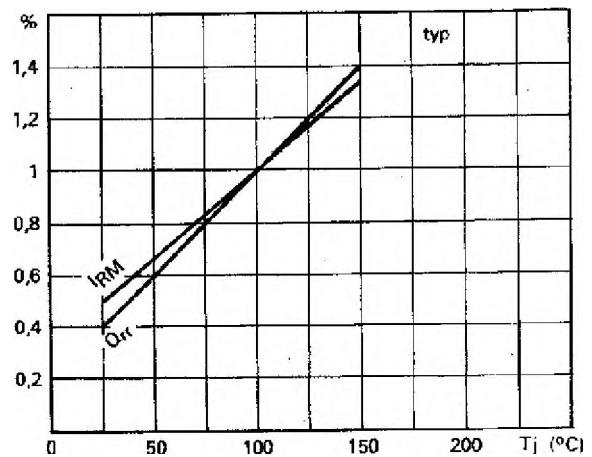

Fig.11 : TURN-OFF SWITCHING CHARACTERISTICS (Without serie inductance)

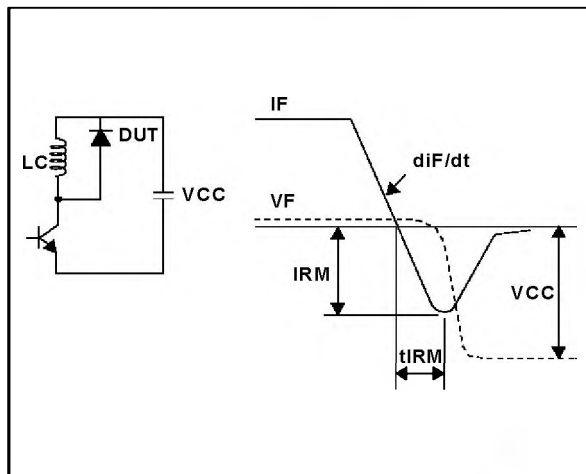
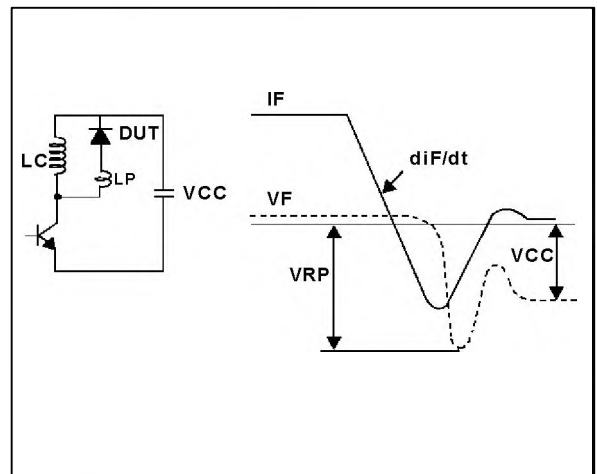
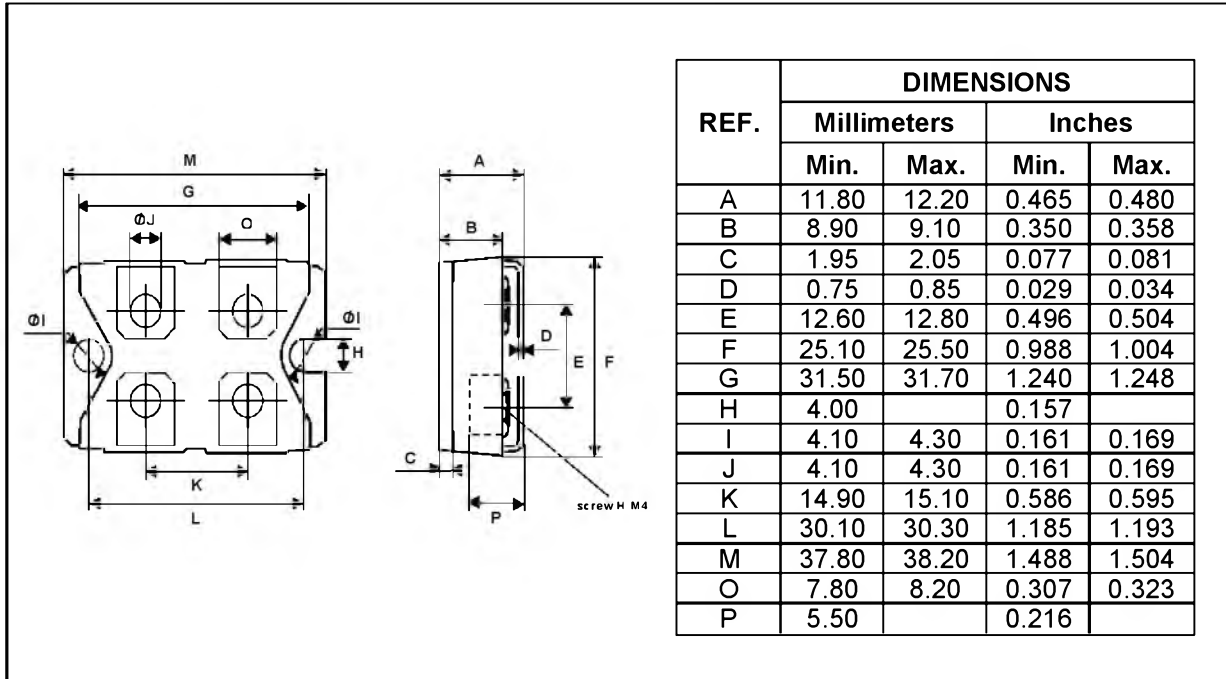

Fig.12 : TURN-OFF SWITCHING CHARACTERISTICS (With serie inductance)



PACKAGE MECHANICAL DATA
ISOTOP



Cooling method : C
 Marking : Type number
 Weight : 28 g (without screws)
 Electric isolation : 2500V_(RMS)
 Capacitance : < 45 pF
 Inductance : < 5 nH

- Recommended torque value : 1.3 N.m (MAX 1.5 N.m) for the 6 x M4 screws. (2 x M4 screws recommended for mounting the package on the heatsink and the 4 screws given with the screw version).
- The screws supplied with the package are adapted for mounting on a board (or other types of terminals) with a thickness of 0.6 mm min and 2.2 mm max.

Information furnished is believed to be accurate and reliable. However, SGS-THOMSON Microelectronics assumes no responsibility for the consequences of use of such information nor for any infringement of patents or other rights of third parties which may result from its use. No license is granted by implication or otherwise under any patent or patent rights of SGS-THOMSON Microelectronics. Specifications mentioned in this publication are subject to change without notice. This publication supersedes and replaces all information previously supplied. SGS-THOMSON Microelectronics products are not authorized for use as critical components in life support devices or systems without express written approval of SGS-THOMSON Microelectronics.

© 1996 SGS-THOMSON Microelectronics - Printed in Italy - All rights reserved.

SGS-THOMSON Microelectronics GROUP OF COMPANIES

Australia - Brazil - Canada - China - France - Germany - Hong Kong - Italy - Japan - Korea - Malaysia - Malta - Morocco - The Netherlands - Singapore - Spain - Sweden - Switzerland - Taiwan - Thailand - United Kingdom - U.S.A.