

## HIGH EFFICIENCY FAST RECOVERY RECTIFIER DIODES

**FEATURES**

PRELIMINARY DATASHEET

- SUITED FOR SMPS
- VERY LOW FORWARD LOSSES
- NEGLIGIBLE SWITCHING LOSSES
- HIGH SURGE CURRENT CAPABILITY
- HIGH AVALANCHE ENERGY CAPABILITY
- INSULATED VERSION TOP3I :  
 Insulating voltage = 2500 V DC  
 Capacitance = 12 pF

**DESCRIPTION**

Dual center tap rectifier suited for switchmode power supply and high frequency DC to DC converters.

Packaged in SOT93, TOP3I or TO247 this device is intended for use in low voltage, high frequency inverters, free wheeling and polarity protection applications.

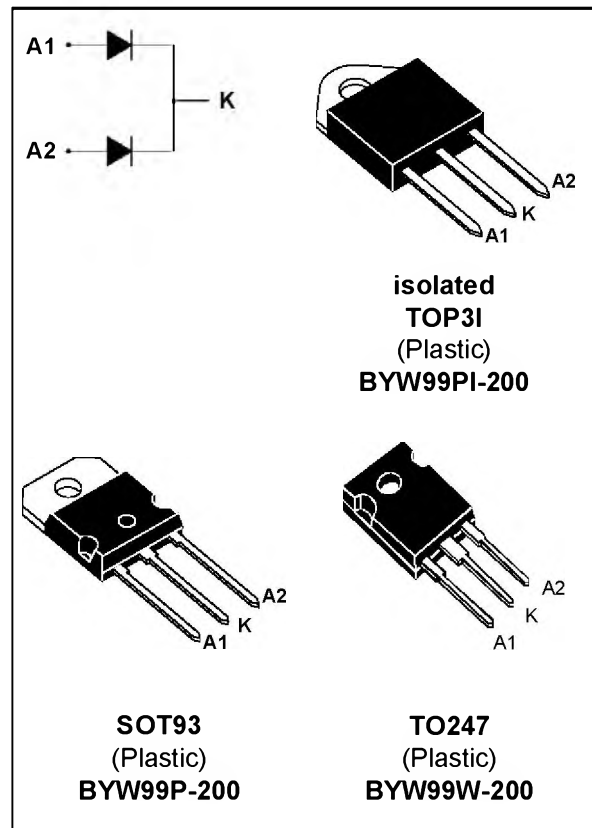
**ABSOLUTE MAXIMUM RATINGS**

Symbol	Parameter			Value	Unit
$I_{F(RMS)}$	RMS forward current			35	A
$I_{F(AV)}$	Average forward current $\delta = 0.5$	SOT93 / TO247	$T_c = 120^\circ\text{C}$	Per diode	15
		TOP3I	$T_c = 115^\circ\text{C}$	Per diode	15
$I_{FSM}$	Surge non repetitive forward current		$t_p = 10\text{ms}$ sinusoidal	Per diode	200
$T_{stg}$ $T_j$	Storage and junction temperature range			- 40 to + 150	$^\circ\text{C}$
				- 40 to + 150	$^\circ\text{C}$

Symbol	Parameter	BYW99P-/PI-/W-				Unit
		50	100	150	200	
$V_{RRM}$	Repetitive peak reverse voltage	50	100	150	200	V

**BYW99P/PI/W****THERMAL RESISTANCE**

Symbol	Parameter			Value	Unit
Rth (j-c)	Junction to case	SOT93 / TO247	Per diode	1.8	°C/W
			Total	1.0	
		TOP3I	Per diode	2.0	
			Total	1.25	
Rth (c)	Coupling	SOT93 / TO247		0.2	°C/W
		TOP3I		0.5	

When the diodes 1 and 2 are used simultaneously :

$$T_j - T_c (\text{diode 1}) = P(\text{diode 1}) \times R_{th}(j-c) (\text{Per diode}) + P(\text{diode 2}) \times R_{th}(c)$$

**ELECTRICAL CHARACTERISTICS (Per diode)  
STATIC CHARACTERISTICS**

Symbol	Test Conditions		Min.	Typ.	Max.	Unit
I <sub>R</sub> *	T <sub>j</sub> = 25°C	V <sub>R</sub> = V <sub>RRM</sub>			20	μA
	T <sub>j</sub> = 100°C				1.5	mA
V <sub>F</sub> **	T <sub>j</sub> = 125°C	I <sub>F</sub> = 12 A			0.85	V
	T <sub>j</sub> = 125°C	I <sub>F</sub> = 25 A			1.05	
	T <sub>j</sub> = 25°C	I <sub>F</sub> = 25 A			1.15	

Pulse test : \* tp = 5 ms, duty cycle < 2 %

\*\* tp = 380 μs, duty cycle < 2 %

To evaluate the conduction losses use the following equation :

$$P = 0.65 \times I_{F(AV)} + 0.016 \times I_{F(RMS)}^2$$

**RECOVERY CHARACTERISTICS**

Symbol	Test Conditions		Min.	Typ.	Max.	Unit
trr	T <sub>j</sub> = 25°C	I <sub>F</sub> = 0.5A I <sub>R</sub> = 1A			25	ns
		I <sub>F</sub> = 1A V <sub>R</sub> = 30V		dI <sub>F</sub> /dt = -50A/μs	40	
tfr	T <sub>j</sub> = 25°C	I <sub>F</sub> = 1A V <sub>FR</sub> = 1.1 x V <sub>F</sub>		15		ns
V <sub>FP</sub>	T <sub>j</sub> = 25°C	I <sub>F</sub> = 1A		2		V

**Fig.1** : Average forward power dissipation versus average forward current.

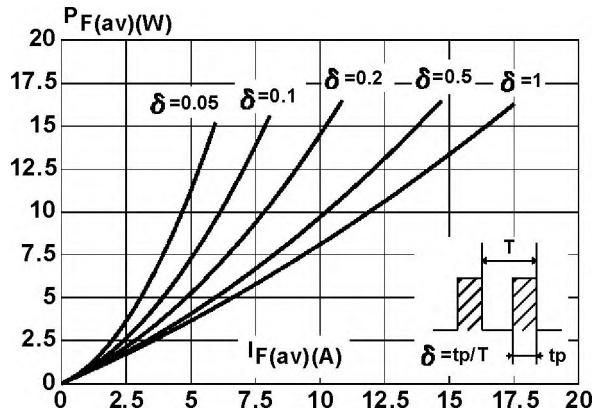

**Fig.2** : Peak current versus form factor.

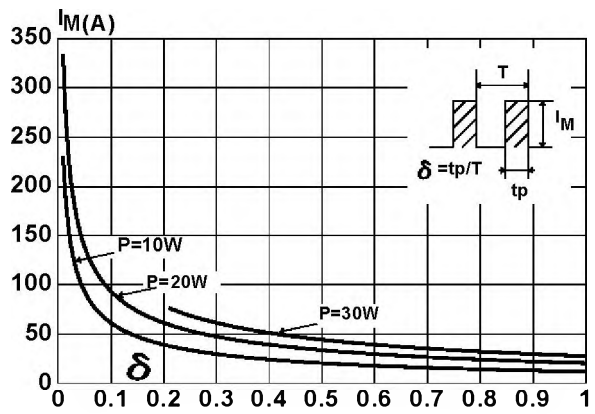

**Fig.3** : Forward voltage drop versus forward current (maximum values).

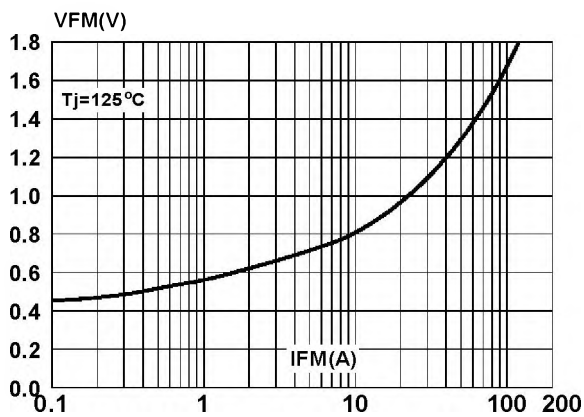

**Fig.4** : Relative variation of thermal impedance junction to case versus pulse duration.

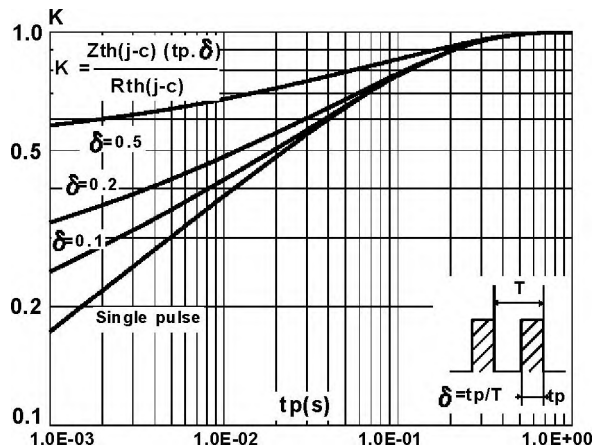

**Fig.5** : Non repetitive surge peak forward current versus overload duration. (SOT93, TO247)

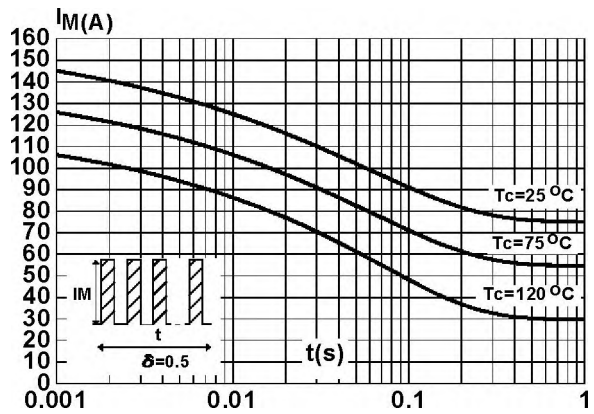

**Fig.6** : Non repetitive surge peak forward current versus overload duration. (TOP31)

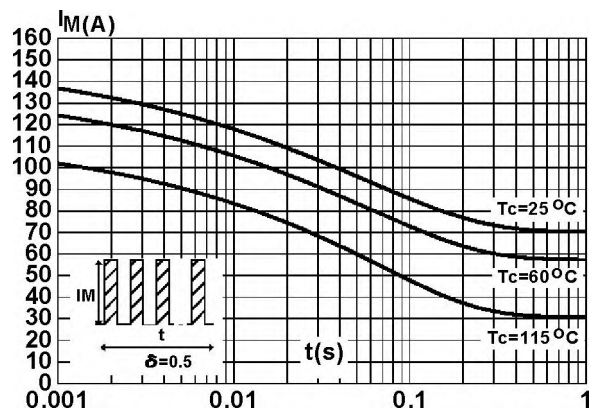

**Fig.7 :** Average current versus ambient temperature.  
(duty cycle : 0.5) (SOT93, TO247)

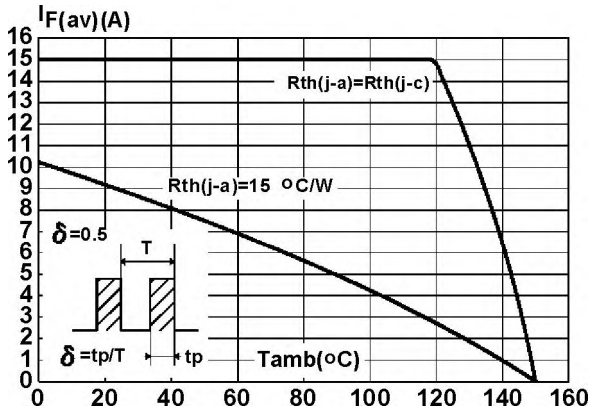

**Fig.8 :** Average current versus ambient temperature.  
(duty cycle : 0.5) (TOP31)

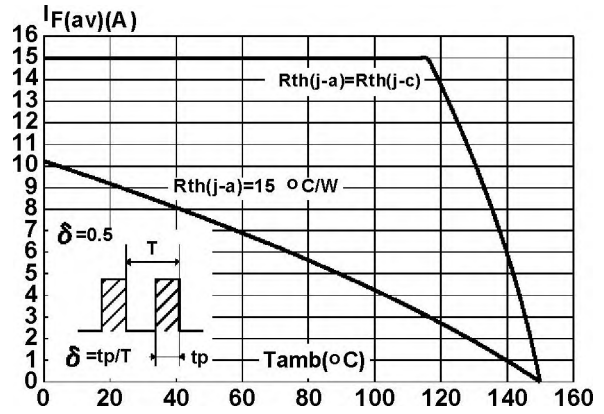

**Fig.9 :** Junction capacitance versus reverse voltage applied (Typical values).

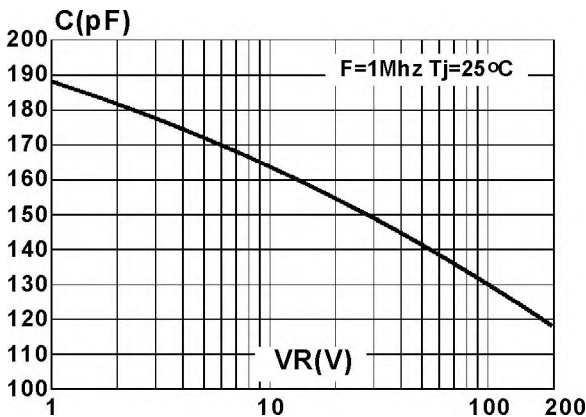

**Fig.10 :** Recovery charges versus  $dI_F/dt$ .

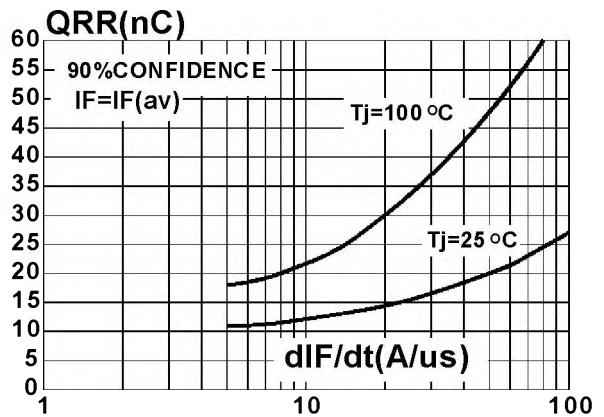

**Fig.11 :** Peak reverse current versus  $dI_F/dt$ .

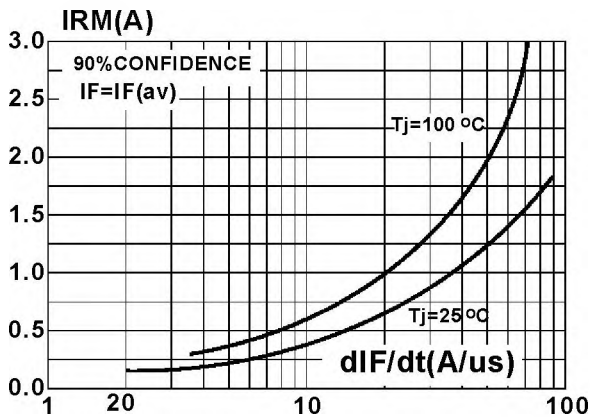

**Fig.12 :** Dynamic parameters versus junction temperature.

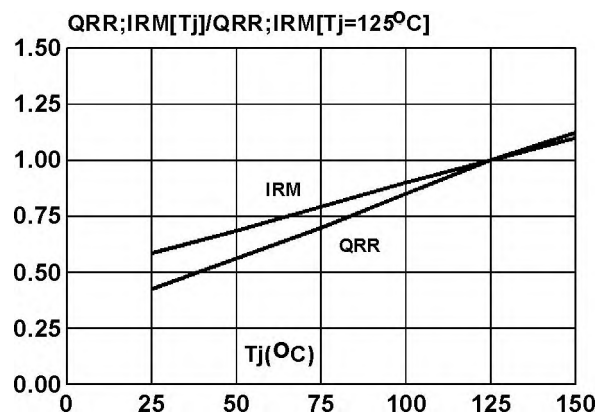

**PACKAGE MECHANICAL DATA**  
SOT93

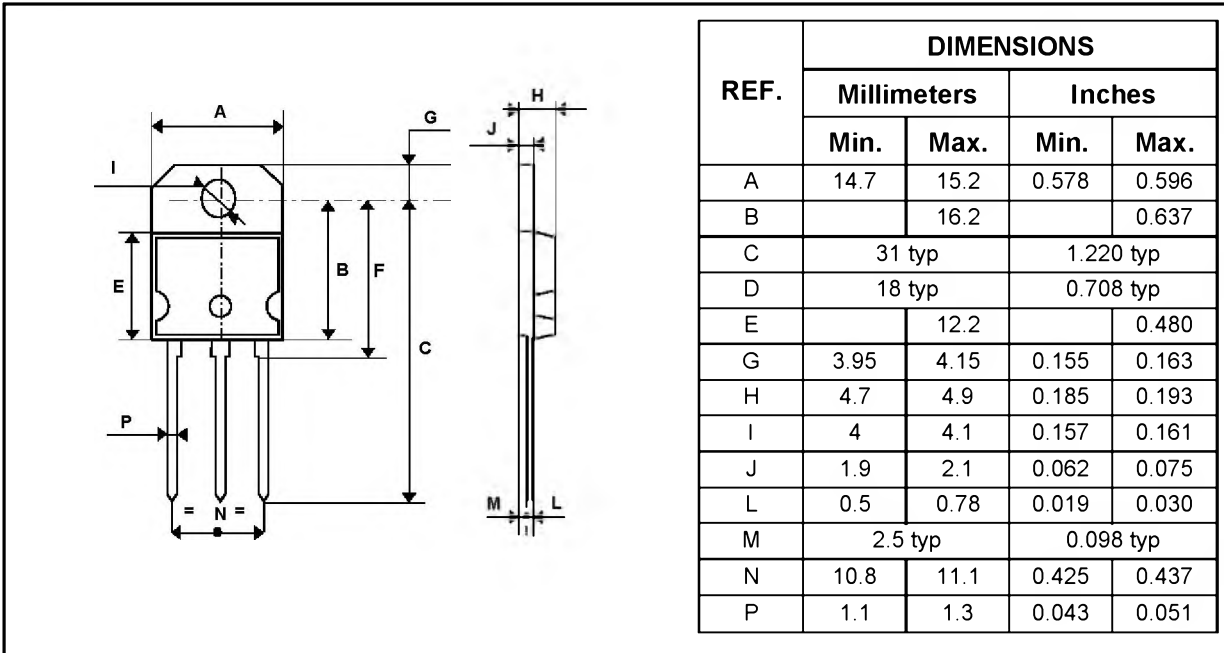

Cooling method : C  
 Marking : Type number  
 Weight : 5.3 g  
 Recommended torque value : 0.8m.N  
 Maximum torque value : 1.0m.N

**PACKAGE MECHANICAL DATA**  
TOP3I (isolated)

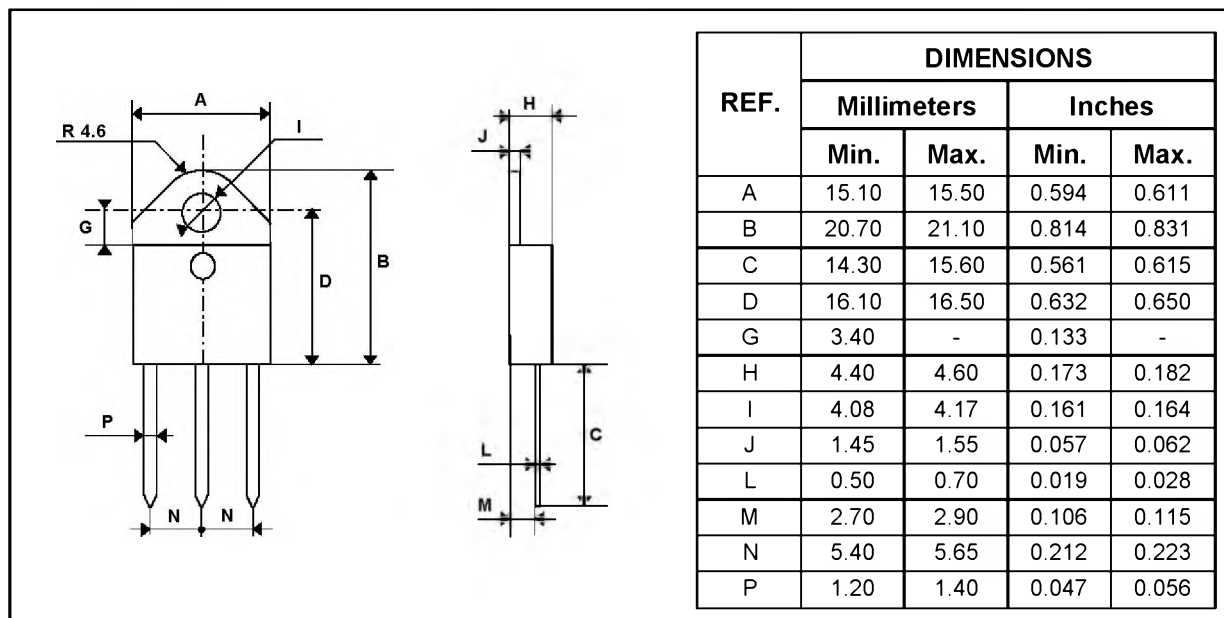

Cooling method : C  
 Marking : Type number  
 Weight : 4.7 g  
 Recommended torque value : 0.8m.N  
 Maximum torque value : 1.0m.N

**BYW99P/PI/W**

**PACKAGE MECHANICAL DATA**  
TO247

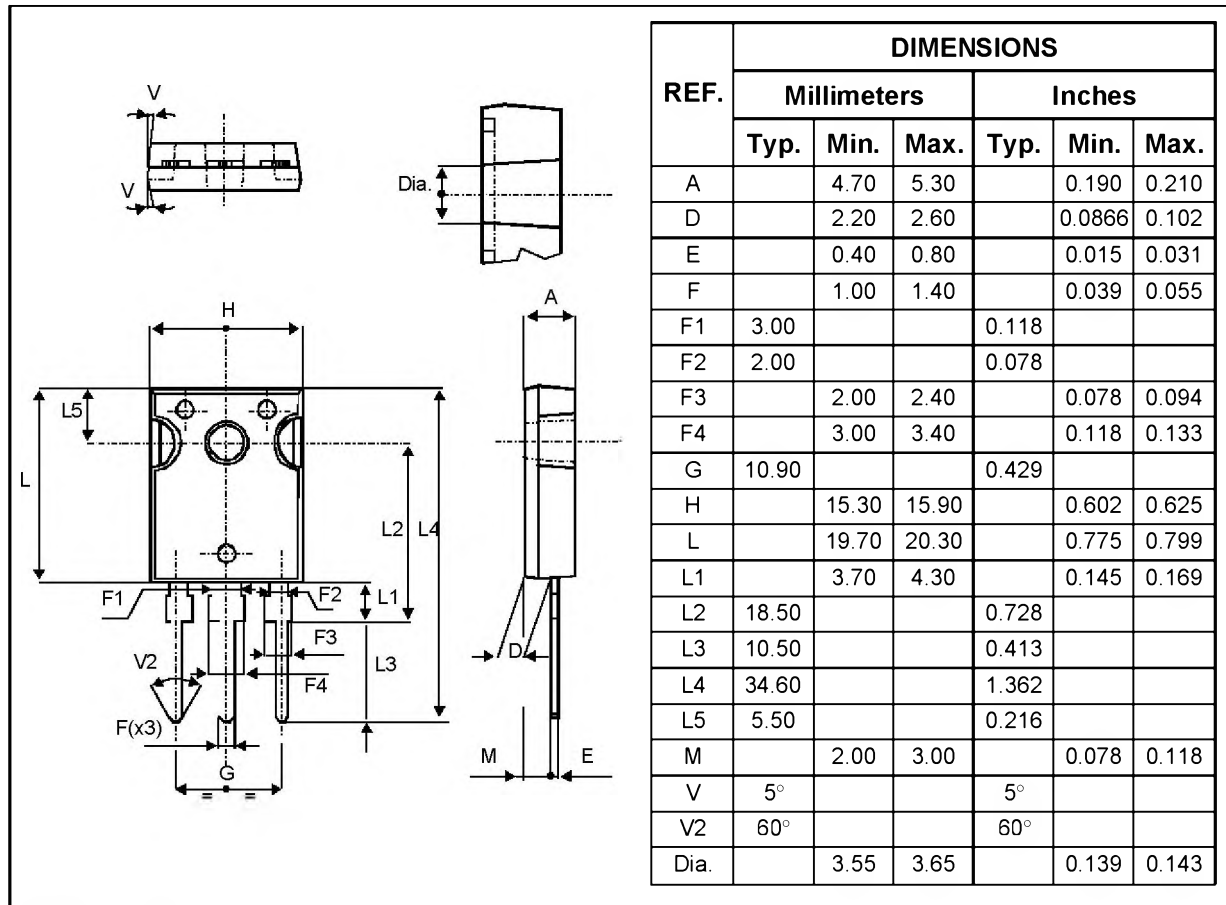

Cooling method : C  
 Marking : Type number  
 Weight : 4.4 g  
 Recommended torque value : 0.8m.N  
 Maximum torque value : 1.0m.N

Information furnished is believed to be accurate and reliable. However, SGS-THOMSON Microelectronics assumes no responsibility for the consequences of use of such information nor for any infringement of patents or other rights of third parties which may result from its use. No license is granted by implication or otherwise under any patent or patent rights of SGS-THOMSON Microelectronics. Specifications mentioned in this publication are subject to change without notice. This publication supersedes and replaces all information previously supplied. SGS-THOMSON Microelectronics products are not authorized for use as critical components in life support devices or systems without express written approval of SGS-THOMSON Microelectronics.

© 1995 SGS-THOMSON Microelectronics - Printed in Italy - All rights reserved.

SGS-THOMSON Microelectronics GROUP OF COMPANIES

Australia - Brazil - France - Germany - Hong Kong - Italy - Japan - Korea - Malaysia - Malta - Morocco - The Netherlands - Singapore - Spain - Sweden - Switzerland - Taiwan - Thailand - United Kingdom - U.S.A.