

FEATURES

- Low Reverse Recovery Charge
- High Switching Speed
- Low Forward Voltage Drop
- Isolated Base
- Dual Diodes Can Be Paralleled for 2400A Rating
- MMC Baseplate With AlN Substrates

APPLICATIONS

- Chopper Diodes
- Boost and Buck Converters
- Free-wheel Circuits
- Snubber Circuits
- Resonant Converters
- Induction Heating
- Multi-level Switch Inverters

The DFM1200FXM12-A000 is a dual 1200 volt, fast recovery diode (FRD) module. Designed for low power loss, the module is suitable for a variety of high voltage applications in motor drives and power conversion.

Fast switching times and low reverse recovery losses allow high frequency operation making the device suitable for the latest drive designs employing pwm and high frequency switching.

These modules incorporate electrically isolated base plates and low inductance construction enabling circuit designers to optimise circuit layouts and utilise grounded heat sinks for safety.

ORDERING INFORMATION

Order As:

DFM1200FXM12-A000

Note: When ordering, please use the complete part number.

KEY PARAMETERS

V_{RRM}		1200V
V_F	(typ)	1.9V
I_F	(max)	1200A
I_{FM}	(max)	2400A

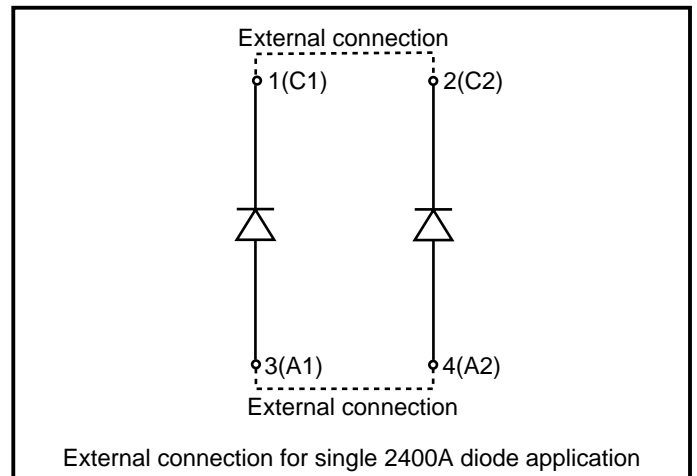

Fig. 1 Circuit diagram

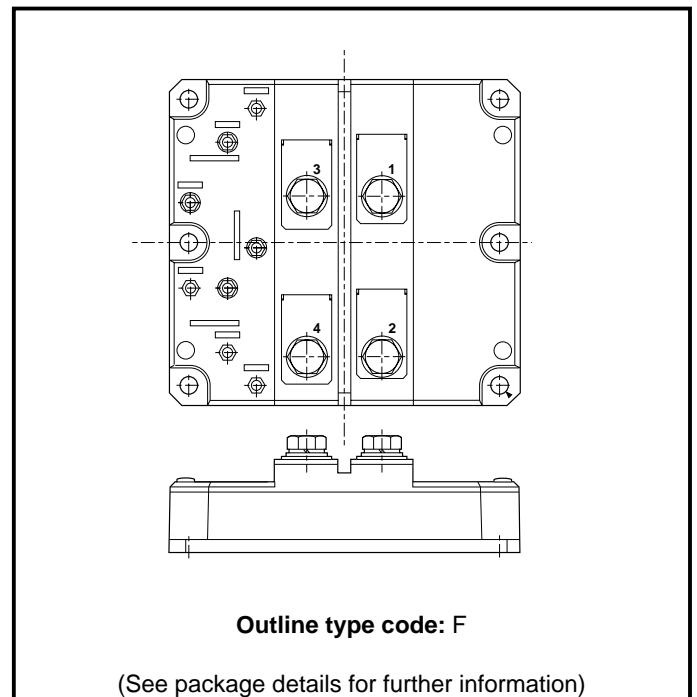

Fig. 2 Electrical connections - (not to scale)

ABSOLUTE MAXIMUM RATINGS - PER ARM

Stresses above those listed under 'Absolute Maximum Ratings' may cause permanent damage to the device. In extreme conditions, as with all semiconductors, this may include potentially hazardous rupture of the package. Appropriate safety precautions should always be followed. Exposure to Absolute Maximum Ratings may affect device reliability.

$T_{case} = 25^{\circ}\text{C}$ unless stated otherwise

Symbol	Parameter	Test Conditions	Max.	Units
V_{RRM}	Repetitive peak reverse voltage	$T_{vj} = 125^{\circ}\text{C}$	1200	V
I_F	Forward current (per arm)	DC, $T_{case} = 75^{\circ}\text{C}$	1200	A
I_{FM}	Max. forward current	$T_{case} = 110^{\circ}\text{C}$, $t_p = 1\text{ms}$	2400	A
I^2t	I^2t value fuse current rating	$V_R = 0$, $t_p = 10\text{ms}$, $T_{vj} = 125^{\circ}\text{C}$	200	kA^2s
Pmax	Maximum power dissipation	$T_{case} = 25^{\circ}\text{C}$, $T_{vj} = 125^{\circ}\text{C}$	5000	W
V_{isol}	Isolation voltage	Commoned terminals to base plate. AC RMS, 1 min, 50Hz	4	kV
Q_{pd}	Partial discharge	IEC1287. $V_1 = 1200\text{V}$, $V_2 = 900\text{V}$, 50Hz RMS	10	pC

THERMAL AND MECHANICAL RATINGS

Internal insulation: AIN
 Baseplate material: AISiC
 Creepage distance: 20mm
 Clearance: 10mm
 CTI (Critical Tracking Index): 175

Symbol	Parameter	Test Conditions	Min.	Typ.	Max.	Units
$R_{th(j-c)}$	Thermal resistance - diode (per arm)	Continuous dissipation - junction to case	-	-	20	$^{\circ}\text{C}/\text{kW}$
$R_{th(c-h)}$	Thermal resistance - case to heatsink (per module)	Mounting torque 5Nm (with mounting grease)	-	-	8	$^{\circ}\text{C}/\text{kW}$
T_j	Junction temperature	-	-	-	125	$^{\circ}\text{C}$
T_{stg}	Storage temperature range	-	-40	-	125	$^{\circ}\text{C}$
-	Screw torque	Mounting - M6	-	-	5	Nm
-		Electrical connections - M8	-	-	10	Nm

STATIC ELECTRICAL CHARACTERISTICS - PER ARM
 $T_{vj} = 25^{\circ}\text{C}$ unless stated otherwise.

Symbol	Parameter	Test Conditions	Min.	Typ.	Max.	Units
I_{RM}	Peak reverse current	$V_R = 1200\text{V}, T_{vj} = 125^{\circ}\text{C}$	-	-	20	mA
V_F	Forward voltage	$I_F = 600\text{A}$	-	1.9	2.2	V
		$I_F = 600\text{A}, T_{vj} = 125^{\circ}\text{C}$	-	2.1	2.4	V
L	Inductance	-	-	20	-	nH

STATIC ELECTRICAL CHARACTERISTICS
 $T_{vj} = 25^{\circ}\text{C}$ unless stated otherwise.

Symbol	Parameter	Test Conditions	Min.	Typ.	Max.	Units
L_M	Module inductance (externally connected in parallel)	-	-	15	-	nH

DYNAMIC ELECTRICAL CHARACTERISTICS - PER ARM
 $T_{vj} = 25^{\circ}\text{C}$ unless stated otherwise.

Symbol	Parameter	Test Conditions	Min.	Typ.	Max.	Units
I_{rr}	Peak reverse recovery current	$I_F = 1200\text{A},$ $di_F/dt = 9000\text{A}/\mu\text{s},$ $V_R = 600\text{V}$	-	800	-	A
Q_{rr}	Reverse recovery charge		-	200	-	μC
E_{rec}	Reverse recovery energy		-	80	-	mJ

 $T_{vj} = 125^{\circ}\text{C}$ unless stated otherwise.

Symbol	Parameter	Test Conditions	Min.	Typ.	Max.	Units
I_{rr}	Peak reverse recovery current	$I_F = 1200\text{A},$ $di_F/dt = 8400\text{A}/\mu\text{s},$ $V_R = 600\text{V}$	-	920	-	A
Q_{rr}	Reverse recovery charge		-	300	-	μC
E_{rec}	Reverse recovery energy		-	140	-	mJ

TYPICAL CHARACTERISTICS

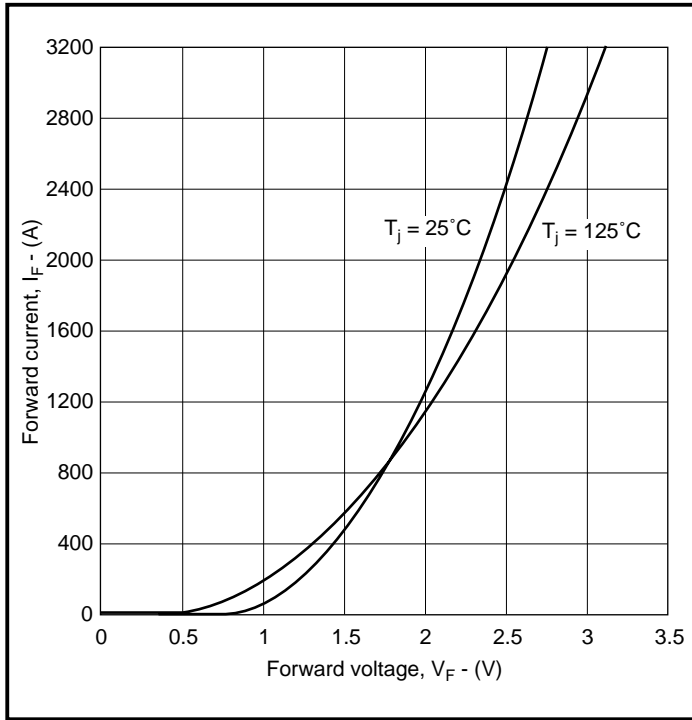

Fig. 2 Diode typical forward characteristics

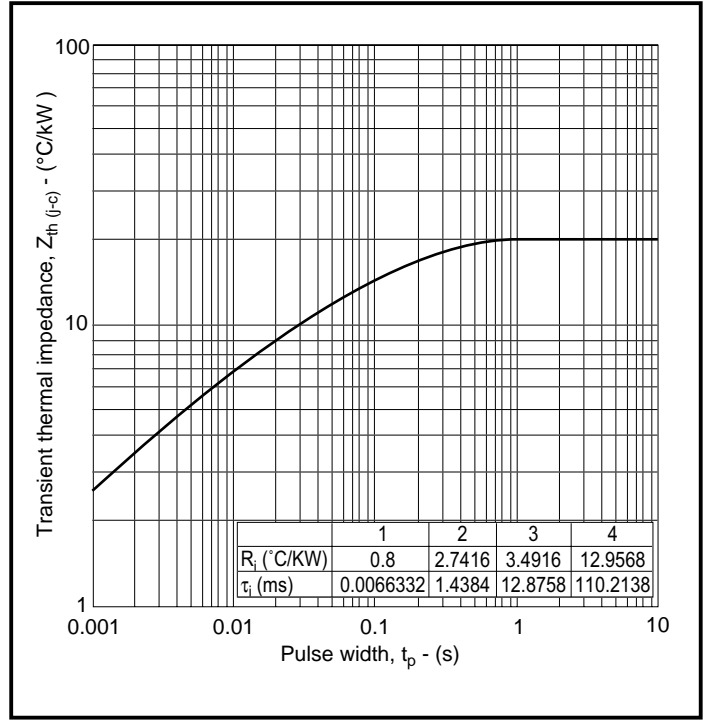

Fig. 4 Transient thermal impedance

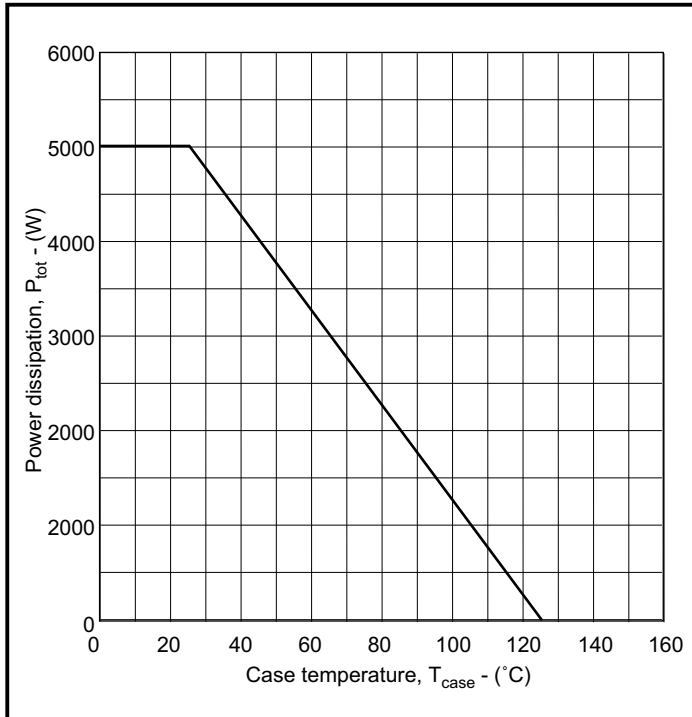

Fig. 5 Power dissipation

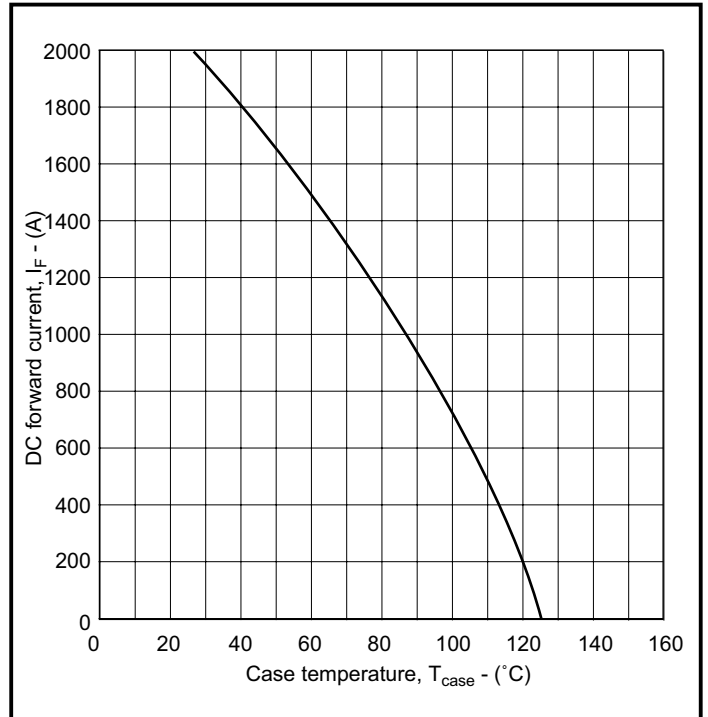

Fig. 6 DC current rating vs case temperature

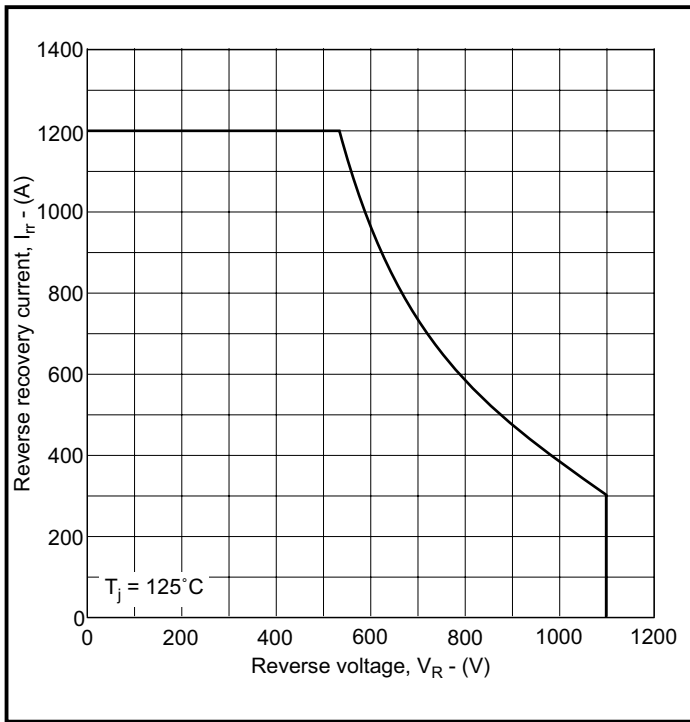
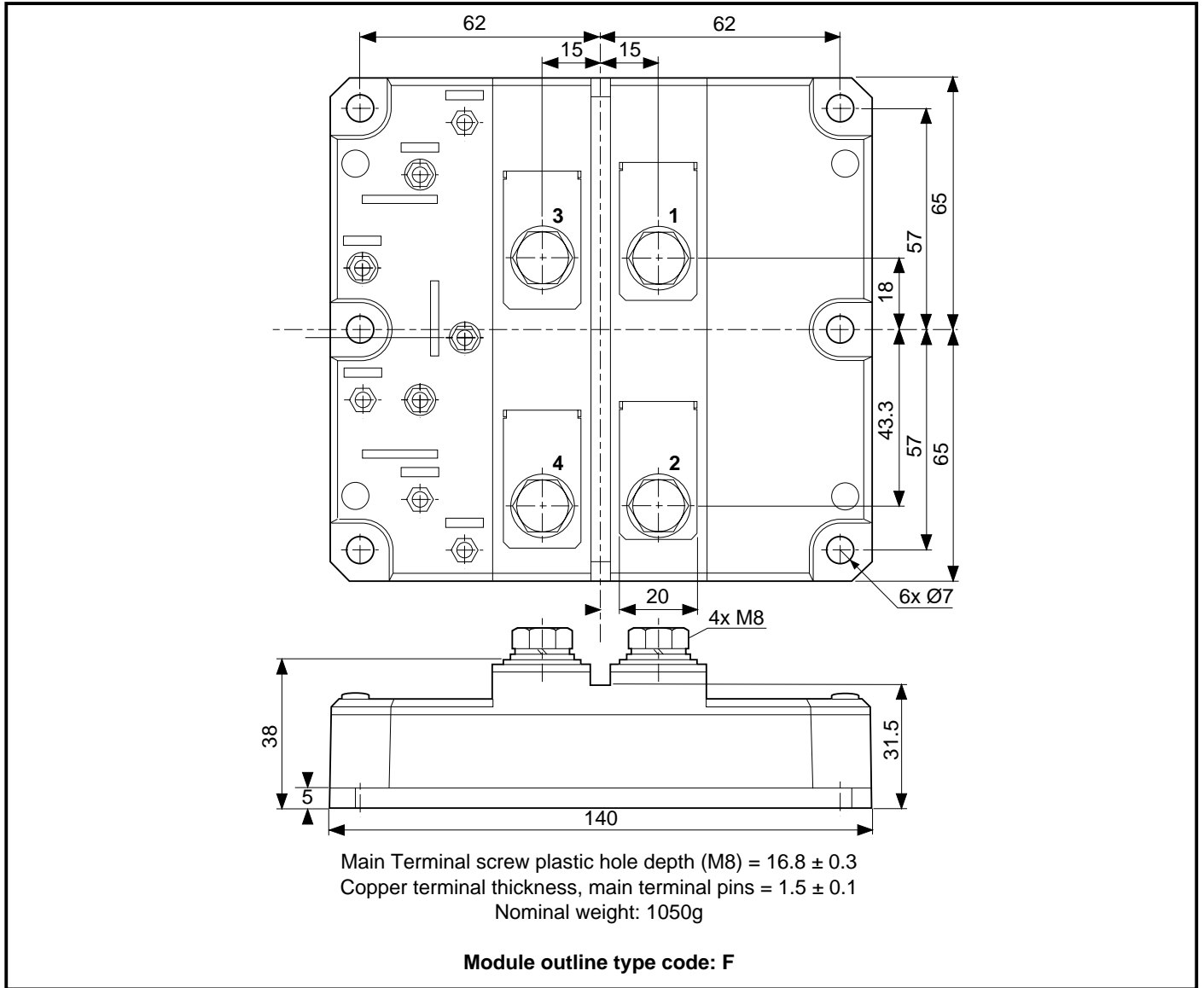

Fig. 7 RBSOA

PACKAGE DETAILS

For further package information, please contact Customer Services. All dimensions in mm, unless stated otherwise. DO NOT SCALE.



POWER ASSEMBLY CAPABILITY

The Power Assembly group was set up to provide a support service for those customers requiring more than the basic semiconductor, and has developed a flexible range of heatsink and clamping systems in line with advances in device voltages and current capability of our semiconductors.

We offer an extensive range of air and liquid cooled assemblies covering the full range of circuit designs in general use today. The Assembly group offers high quality engineering support dedicated to designing new units to satisfy the growing needs of our customers.

Using the latest CAD methods our team of design and applications engineers aim to provide the Power Assembly Complete Solution (PACs).

HEATSINKS

The Power Assembly group has its own proprietary range of extruded aluminium heatsinks which have been designed to optimise the performance of Dynex semiconductors. Data with respect to air natural, forced air and liquid cooling (with flow rates) is available on request.

For further information on device clamps, heatsinks and assemblies, please contact your nearest sales representative or Customer Services.



<http://www.dynexsemi.com>

e-mail: power_solutions@dynexsemi.com

HEADQUARTERS OPERATIONS
DYNEX SEMICONDUCTOR LTD
Doddington Road, Lincoln.
Lincolnshire. LN6 3LF. United Kingdom.
Tel: +44-(0)1522-500500
Fax: +44-(0)1522-500550

CUSTOMER SERVICE
Tel: +44 (0)1522 502753 / 502901. Fax: +44 (0)1522 500020

SALES OFFICES
Benelux, Italy & Switzerland: Tel: +33 (0)1 64 66 42 17. Fax: +33 (0)1 64 66 42 19.
France: Tel: +33 (0)2 47 55 75 52. Fax: +33 (0)2 47 55 75 59.
Germany, Northern Europe, Spain & Rest Of World: Tel: +44 (0)1522 502753 / 502901.
Fax: +44 (0)1522 500020
North America: Tel: (613) 723-7035. Fax: (613) 723-1518. Toll Free: 1.888.33.DYNEX (39639) /
Tel: (949) 733-3005. Fax: (949) 733-2986.

These offices are supported by Representatives and Distributors in many countries world-wide.
© Dynex Semiconductor 2002 TECHNICAL DOCUMENTATION – NOT FOR RESALE. PRODUCED IN UNITED KINGDOM

Datasheet Annotations:

Dynex Semiconductor annotate datasheets in the top right hand corner of the front page, to indicate product status. The annotations are as follows:-

Target Information: This is the most tentative form of information and represents a very preliminary specification. No actual design work on the product has been started.

Preliminary Information: The product is in design and development. The datasheet represents the product as it is understood but details may change.

Advance Information: The product design is complete and final characterisation for volume production is well in hand.

No Annotation: The product parameters are fixed and the product is available to datasheet specification.

This publication is issued to provide information only which (unless agreed by the Company in writing) may not be used, applied or reproduced for any purpose nor form part of any order or contract nor to be regarded as a representation relating to the products or services concerned. No warranty or guarantee express or implied is made regarding the capability, performance or suitability of any product or service. The Company reserves the right to alter without prior notice the specification, design or price of any product or service. Information concerning possible methods of use is provided as a guide only and does not constitute any guarantee that such methods of use will be satisfactory in a specific piece of equipment. It is the user's responsibility to fully determine the performance and suitability of any equipment using such information and to ensure that any publication or data used is up to date and has not been superseded. These products are not suitable for use in any medical products whose failure to perform may result in significant injury or death to the user. All products and materials are sold and services provided subject to the Company's conditions of sale, which are available on request.

All brand names and product names used in this publication are trademarks, registered trademarks or trade names of their respective owners.