

## IRK.F112.. SERIES

**FAST THYRISTOR/ DIODE and  
 THYRISTOR/THYRISTOR**

**INT-A-pak™ Power Modules**



### Features

- Fast turn-off thyristor
- Fast recovery diode
- High surge capability
- Electrically isolated baseplate
- 3000 V<sub>RMS</sub> isolating voltage
- Industrial standard package
- UL E78996 approved

### Description

These series of INT-A-pak modules are intended for applications such as self-commutated inverters, DC choppers, electronic welders, induction heating and others where fast switching characteristics are required.

### Major Ratings and Characteristics

Parameters	IRK.F112..	Units
$I_{T(AV)}$	112	A
@ $T_C$	90	°C
$I_{T(RMS)}$	250	A
$I_{TSM}$ @ 50Hz	3090	A
@ 60Hz	3237	A
$I^2t$ @ 50Hz	47.8	KA <sup>2</sup> s
@ 60Hz	43.6	KA <sup>2</sup> s
$I^2\sqrt{t}$	478	KA <sup>2</sup> √s
$t_q$	10 and 15	μs
$t_{rr}$	2	μs
$V_{DRM}/V_{RRM}$	up to 800	V
$T_J$ range	-40 to 125	°C

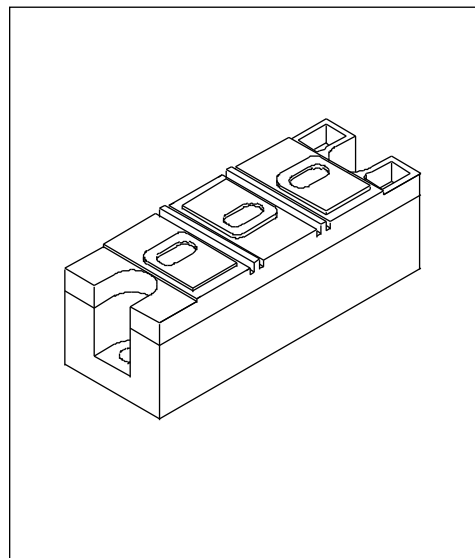

## IRK.F112.. Series

Bulletin I27091 rev. A 09/97

International  
 Rectifier

### ELECTRICAL SPECIFICATIONS

#### Voltage Ratings

Type number	Voltage Code	$V_{RRM}/V_{DRM}$ , maximum repetitive peak reverse voltage V	$V_{RSM}$ , maximum non-repetitive peak rev. voltage V	$I_{RRM}/I_{DRM}$ max. @ $T_J = 125^\circ\text{C}$ mA
IRK.F112.. Series	04	400	400	30
	08	800	800	

#### Current Carrying Capacity

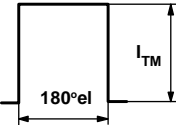
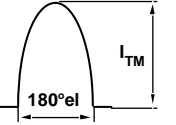
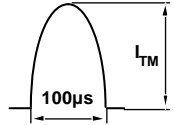
Frequency f							Units
	220	220	350	550	2060	2900	
50Hz	220	220	350	550	2060	2900	A
400Hz	285	285	425	695	1230	1785	A
2500Hz	205	205	350	550	460	552	A
5000Hz	175	170	295	448	295	448	A
10000Hz	125	120	230	337	-	-	A
Recovery voltage Vr	50	50	50	50	50	50	V
Voltage before turn-on Vd	80% $V_{DRM}$		80% $V_{DRM}$		80% $V_{DRM}$		V
Rise of on-state current di/dt	50	50	-	-	-	-	A/µs
Case temperature	90	60	90	60	90	60	°C
Equivalent values for RC circuit	47 Ω / 0.22 µF		47 Ω / 0.22 µF		47 Ω / 0.22 µF		

#### On-state Conduction

Parameter	IRK.F112..	Units	Conditions
$I_{T(AV)}$ Maximum average on-state current @ Case temperature	112	A	180° conduction, half sine wave
	90	°C	
$I_{T(RMS)}$ Maximum RMS current	250	A	$T_C = 90^\circ\text{C}$ , as AC switch
$I_{TSM}$ Maximum peak, one-cycle, non-repetitive surge current	3090	A	t = 10ms No voltage reappplied
	3237		t = 8.3ms 100% $V_{RRM}$ reappplied
	2600		t = 10ms No voltage reappplied
	2720		t = 8.3ms 100% $V_{RRM}$ reappplied
$I^2t$ Maximum $I^2t$ for fusing	47.8	KA <sup>2</sup> s	t = 10ms No voltage reappplied
	43.6		t = 8.3ms 100% $V_{RRM}$ reappplied
	33.8		t = 10ms No voltage reappplied
	30.8		t = 8.3ms 100% $V_{RRM}$ reappplied
$I^2\sqrt{t}$ Maximum $I^2\sqrt{t}$ for fusing	478	KA <sup>2</sup> √s	t = 0 to 10ms, no voltage reappplied
$V_{T(TO)1}$ Low level value of threshold voltage	1.19	V	$(16.7\% \times \pi \times I_{T(AV)} < I < \pi \times I_{T(AV)})$ , $T_J = T_J \text{ max.}$
$V_{T(TO)2}$ High level value of threshold voltage	1.43		$(I > \pi \times I_{T(AV)})$ , $T_J = T_J \text{ max.}$
$r_{t1}$ Low level value of on-state slope resistance	1.67	mW	$(16.7\% \times \pi \times I_{T(AV)} < I < \pi \times I_{T(AV)})$ , $T_J = T_J \text{ max.}$
$r_{t2}$ High level value of on-state slope resistance	1.12		$(I > \pi \times I_{T(AV)})$ , $T_J = T_J \text{ max.}$
$V_{TM}$ Maximum on-state voltage drop	1.77	V	$I_{pk} = 350\text{A}$ , $T_J = T_J \text{ max.}$ , $t_p = 10\text{ms}$ sine pulse
$I_H$ Maximum holding current	600	mA	$T_J = 25^\circ\text{C}$ , $I_T > 30\text{A}$
$I_L$ Typical latching current	1000	mA	$T_J = 25^\circ\text{C}$ , $V_A = 12\text{V}$ , $R_a = 6\Omega$ , $I_g = 1\text{A}$

**Switching**

Parameter	IRK.F112..	Units	Conditions
di/dt Maximum non-repetitive rate of rise	800	A/μs	Gate drive 20V, 20Ω, tr ≤ 1ms, V <sub>D</sub> = 80% V <sub>DRM</sub> T <sub>J</sub> = 125°C
t <sub>rr</sub> Maximum recovery time	2	μs	I <sub>TM</sub> = 350A, di/dt = -25A/μs, V <sub>R</sub> = 50V, T <sub>J</sub> = 25°C
t <sub>q</sub> Maximum turn-off time	N 10	L 15 μs	I <sub>TM</sub> = 350A, T <sub>J</sub> = 125°C, di/dt = -25A/μs, V <sub>R</sub> = 50V, dv/dt = 400V/μs linear to 80% V <sub>DRM</sub>

**Blocking**

Parameter	IRK.F112..	Units	Conditions
dv/dt Maximum critical rate of rise of off-state voltage	1000	V/μs	T <sub>J</sub> = 125°C., exponential to 67% V <sub>DRM</sub>
V <sub>INS</sub> RMS isolation voltage	3000	V	50 Hz, circuit to base, T <sub>J</sub> = 25°C, t = 1 s
I <sub>R<sub>RRM</sub></sub> I <sub>DRM</sub> Maximum peak reverse and off-state leakage current	30	mA	T <sub>J</sub> = 125°C, rated V <sub>DRM</sub> /V <sub>R<sub>RRM</sub></sub> applied

**Triggering**

Parameter	IRK.F112..	Units	Conditions
P <sub>GM</sub> Maximum peak gate power	60	W	f = 50 Hz, d% = 50
P <sub>G(AV)</sub> Maximum peak average gate power	10	W	T <sub>J</sub> = 125°C, f = 50Hz, d% = 50
I <sub>GM</sub> Maximum peak positive gate current	10	A	T <sub>J</sub> = 125°C, t <sub>p</sub> ≤ 5ms
- V <sub>GM</sub> Maximum peak negative gate voltage	5	V	
I <sub>GT</sub> Max. DC gate current required to trigger	200	mA	T <sub>J</sub> = 25°C, V <sub>ak</sub> 12V, Ra = 6
V <sub>GT</sub> DC gate voltage required to trigger	3	V	
I <sub>GD</sub> DC gate current not to trigger	20	mA	T <sub>J</sub> = 125°C, rated V <sub>DRM</sub> applied
V <sub>GD</sub> DC gate voltage not to trigger	0.25	V	

**Thermal and Mechanical Specifications**

Parameter	IRK.F112..	Units	Conditions
T <sub>J</sub> Max. junction operating temperature range	- 40 to 125	°C	
T <sub>stg</sub> Max. storage temperature range	- 40 to 150		
R <sub>thJC</sub> Max. thermal resistance, junction to case	0.17	K/W	Per junction, DC operation
R <sub>thC-hs</sub> Max. thermal resistance, case to heatsink	0.035	K/W	Mounting surface flat and greased Per module
T Mounting torque ± 10%	IAP to heatsink	4 - 6 (35 - 53)	A mounting compound is recommended. The torque should be rechecked after a period of 3 hours to allow for the spread of the compound. Use of cable lugs is not recommended, busbars should be used and restrained during tightening. Threads must be lubricated with a compound
	busbar to IAP	4 - 6 (35 - 53)	
wt Approximate weight	500 (17.8)	Nm (lb*in) g (oz)	

## IRK.F112.. Series

Bulletin I27091 rev. A 09/97

International  
**IR** Rectifier

### $\Delta R_{thJC}$ Conduction

(The following table shows the increment of thermal resistance  $R_{thJC}$  when devices operate at different conduction angles than DC)

Conduction angle	Sinusoidal conduction	Rectangular conduction	Units	Conditions
180°	0.015	0.012	K/W	$T_J = 125^\circ\text{C}$
120°	0.018	0.020		
90°	0.024	0.027		
60°	0.036	0.037		
30°	0.060	0.060		

### Ordering Information Table

Device Code										
	<b>IRK</b>	<b>T</b>	<b>F</b>	<b>11</b>	<b>2</b>	<b>-</b>	<b>08</b>	<b>H</b>	<b>L</b>	<b>N</b>
	①	②	③	④	⑤		⑥	⑦	⑧	⑨
<b>1</b>	- Module type									
<b>2</b>	- Circuit configuration									
<b>3</b>	- Fast SCR									
<b>4</b>	- Current rating: $I_{T(AV)} \times 10$ rounded									
<b>5</b>	- 1 = option with spacers and longer terminal screws 2 = option with standard terminal screws									
<b>6</b>	- Voltage code: Code $\times 100 = V_{RRM}$ (See Voltage Ratings Table)									
<b>7</b>	- dv/dt code: H $\leq 400\text{V}/\mu\text{s}$									
<b>8</b>	- $t_q$ code: N $\leq 10\mu\text{s}$ L $\leq 15\mu\text{s}$									
<b>9</b>	- None = Standard devices N = Aluminum nitride substrate									

**NOTE: To order the Optional Hardware see Bulletin I27900**

Outline Table

- All dimensions in millimeters (inches)  
 - Dimensions are nominal  
 - Full engineering drawings are available on request  
 - UL identification number for gate and cathode wire: UL 1385  
 - UL identification number for package: UL 94V0

For all types	A	B	C	D	E
IRK...1	25 (0.98)	----	----	41 (1.61)	47 (1.85)
IRK...2	23 (0.91)	30 (1.18)	36 (1.42)	----	----

IRKTF.. IRKHF.. IRKLF.. IRKUF.. IRKV.. IRKVF.. IRKKF.. IRKNF..

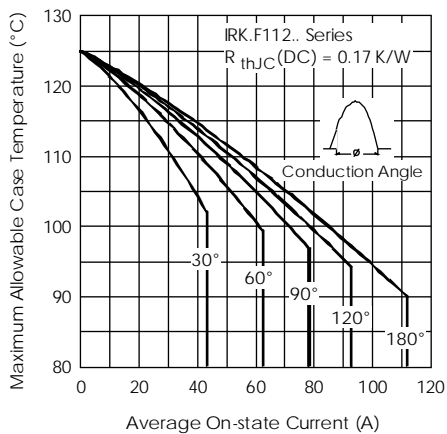

Fig. 1 - Current Ratings Characteristics

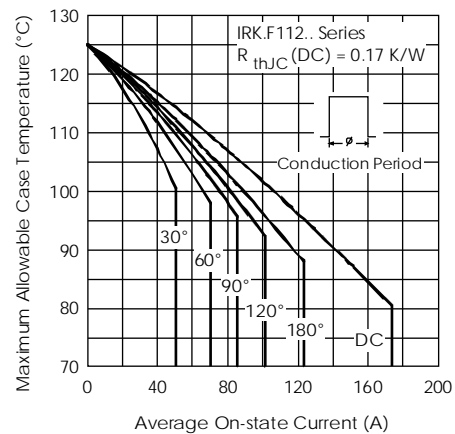

Fig. 2 - Current Ratings Characteristics

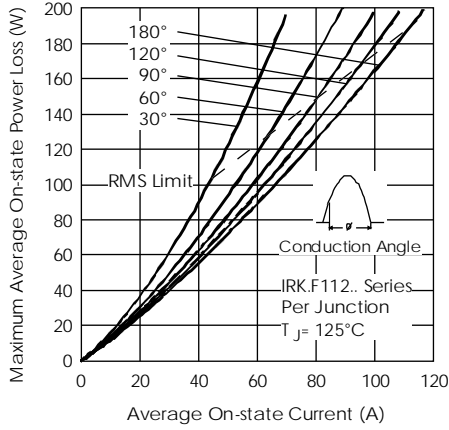

Fig. 3 - On-state Power Loss Characteristics

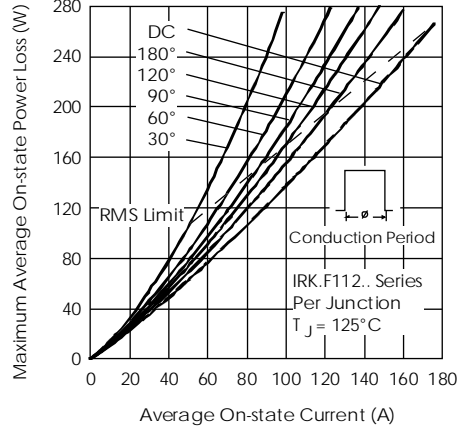

Fig. 4 - On-state Power Loss Characteristics

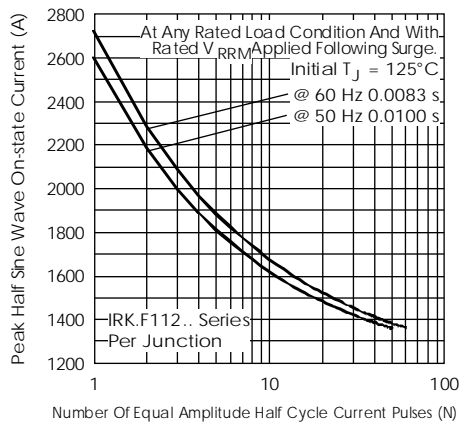

Fig. 5 - Maximum Non-Repetitive Surge Current

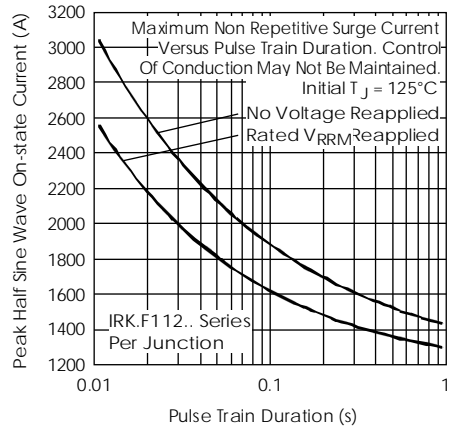

Fig. 6 - Maximum Non-Repetitive Surge Current

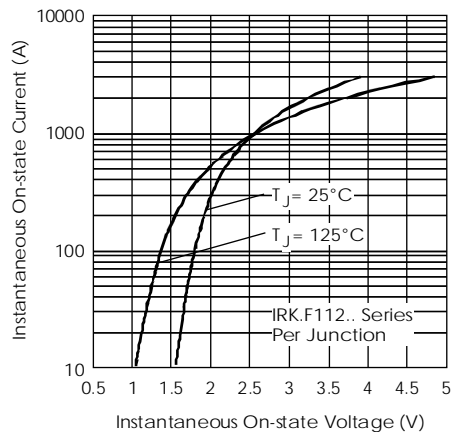

Fig. 7 - On-state Voltage Drop Characteristics

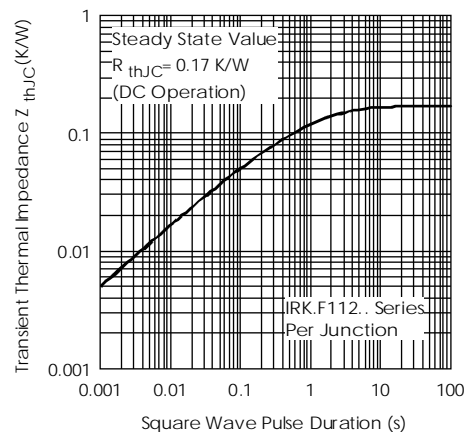

Fig. 8 - Thermal Impedance  $Z_{thJC}$  Characteristic

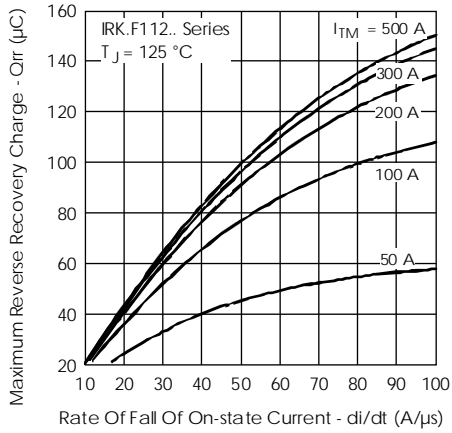

Fig. 9 - Reverse Recovery Charge Characteristics

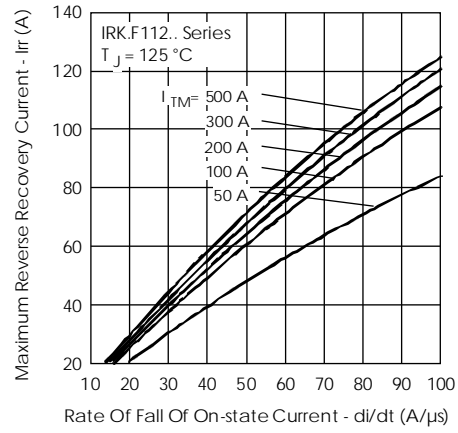

Fig. 10 - Reverse Recovery Current Characteristics

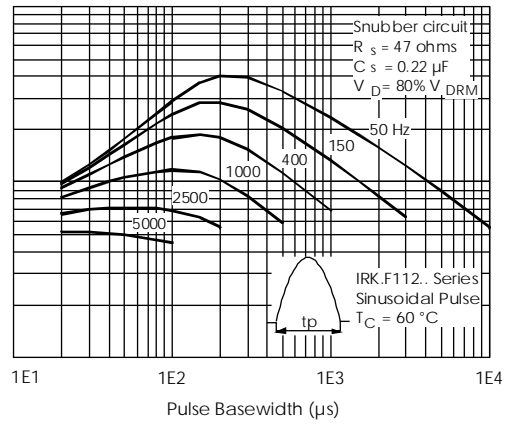
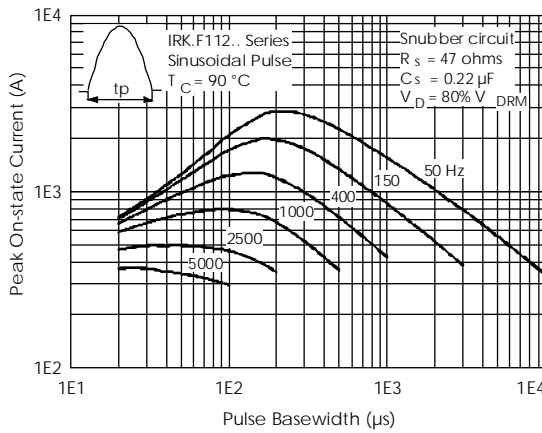

Fig. 11 - Frequency Characteristics

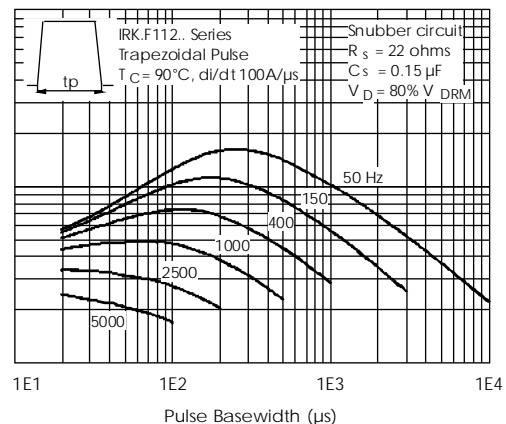
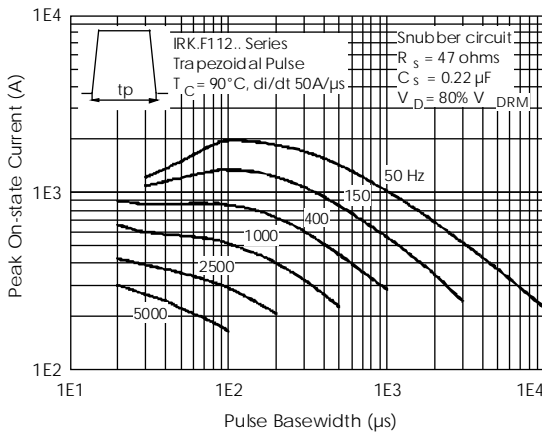

Fig. 12 - Frequency Characteristics

# IRK.F112.. Series

Bulletin I27091 rev. A 09/97

International  
**IR** Rectifier

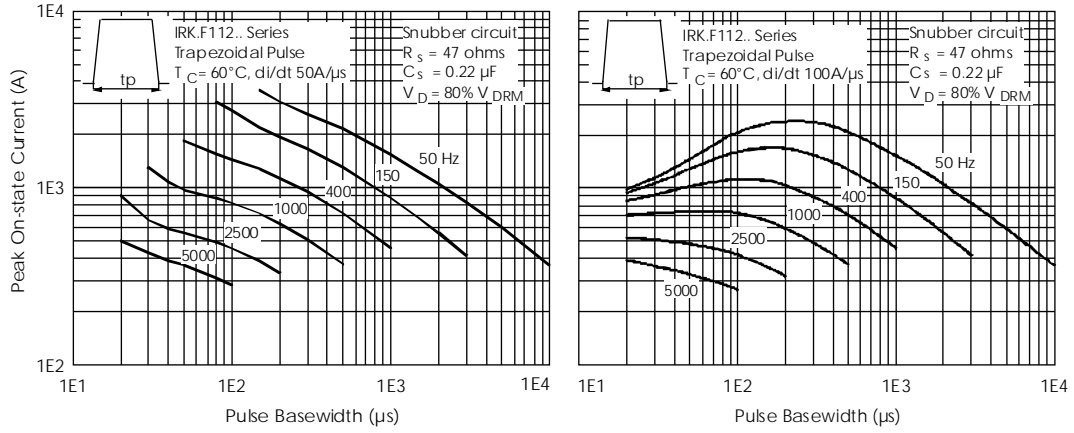

Fig. 13 - Frequency Characteristics

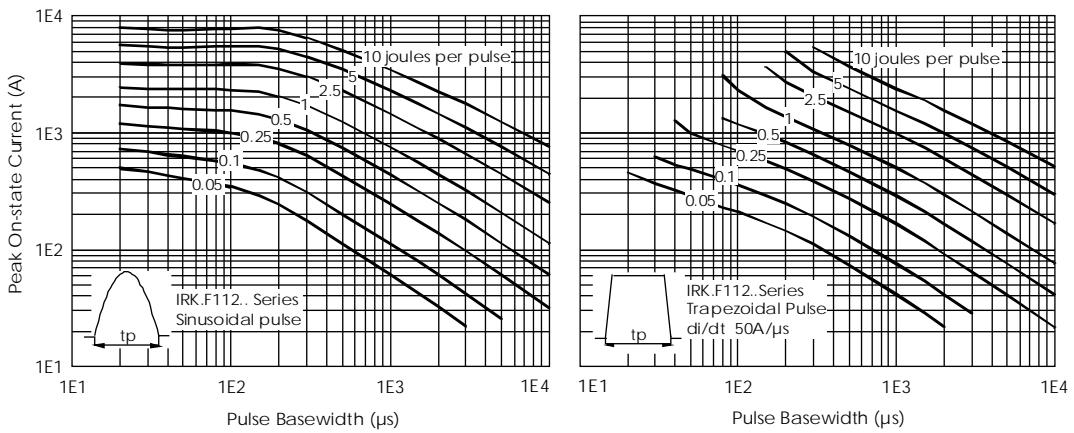

Fig. 14 - Maximum On-state Energy Power Loss Characteristics

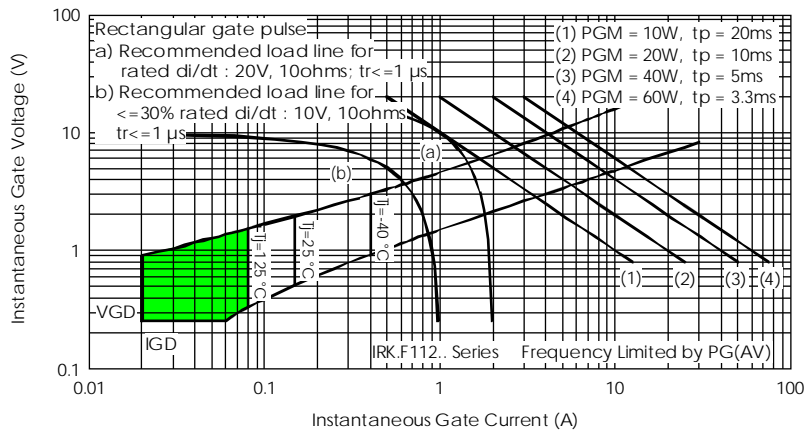

Fig. 15 - Gate Characteristics