

MM3Z2V4B-MM3Z75VB

Zener Diodes

Features

- Wide Zener Voltage Range Selection, 2.4V to 75V
- VZ Tolerance Selection of $\pm 2\%$ (B Series)
- Very Small and Thin SMD package
- Matte Tin(Sn) finish, Pb Free

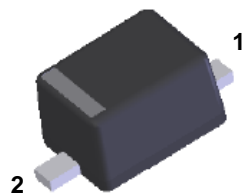

* Band Denotes Cathode **SOD-323F**

Connection Diagram

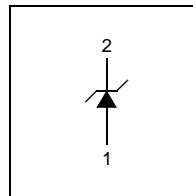

Absolute Maximum Ratings $T_A = 25^\circ\text{C}$ unless otherwise noted

Symbol	Parameter	Value	Units
P_D	Power Dissipation	200	mW
T_{STG}	Storage Temperature Range	-65 to +150	$^\circ\text{C}$
T_J	Maximum Junction Temperature	150	$^\circ\text{C}$
I_{ZM}	Maximum Regulator Current	P_D/V_Z	mA

* These ratings are limiting values above which the serviceability of the diode may be impaired.

Thermal Characteristics

Symbol	Parameter	Value	Unit
$R_{\theta JA}$	Thermal Resistance, Junction to Ambient	595	$^\circ\text{C}/\text{W}$

* Device mounted on FR-4 PCB minimum land pad.

Electrical Characteristics $T_A = 25^\circ\text{C}$ unless otherwise specified

Symbol	Parameter/ Test condition	Min.	Typ.	Max.	Unit
V_F	Forward Voltage / $I_F=10\text{mA}$	--	--	1.0	V

Package Marking and Ordering Information

Device Marking	Device	Package	Packing	Reel Size	Tape Width	Quantity
Refer to Product table list	Refer to Product table list	SOD-323F	Tape & Reel	7"	12mm	3,000

Electrical Characteristics $T_A=25^\circ\text{C}$ unless otherwise noted

Device Type	Device Marking	V_Z (V) @ I_{ZT}			$Z_{ZT}(\Omega)$ @ I_{ZT}	I_{ZT} (mA)	$Z_{ZK}(\Omega)$ @ I_{ZK}	I_{ZK} (mA)	$I_R(\mu\text{A})$ @ V_R	V_R (V)
		Min.	Typ.	Max.	Max.	-	Max.	-	Max	-
MM3Z2V4B	0Z	2.35	2.4	2.45	94	5	564	1	45	1
MM3Z2V7B	1Z	2.65	2.7	2.75	94	5	564	1	18	1
MM3Z3V0B	2Z	2.94	3.0	3.06	89	5	564	1	9	1
MM3Z3V3B	3Z	3.23	3.3	3.37	89	5	564	1	4.5	1
MM3Z3V6B	4Z	3.53	3.6	3.67	84	5	564	1	4.5	1
MM3Z3V9B	5Z	3.82	3.9	3.98	84	5	564	1	2.7	1
MM3Z4V3B	6Z	4.21	4.3	4.39	84	5	564	1	2.7	1
MM3Z4V7B	7Z	4.61	4.7	4.79	75	5	470	1	2.7	2
MM3Z5V1B	8Z	5.00	5.1	5.20	56	5	451	1	1.8	2
MM3Z5V6B	9Z	5.49	5.6	5.71	37	5	376	1	0.9	2
MM3Z6V2B	AZ	6.08	6.2	6.32	9	5	141	1	2.7	4
MM3Z6V8B	BZ	6.66	6.8	6.94	14	5	75	1	1.8	4
MM3Z7V5B	CZ	7.35	7.5	7.65	14	5	75	1	0.9	5
MM3Z8V2B	DZ	8.04	8.2	8.36	14	5	75	1	0.63	5
MM3Z9V1B	EZ	8.92	9.1	9.28	14	5	94	1	0.45	6
MM3Z10VB	FZ	9.80	10	10.20	18	5	141	1	0.18	7
MM3Z11VB	GZ	10.78	11	11.22	18	5	141	1	0.09	8
MM3Z12VB	HZ	11.76	12	12.24	23	5	141	1	0.09	8
MM3Z13VB	JZ	12.74	13	13.26	28	5	160	1	0.09	8
MM3Z15VB	KZ	14.70	15	15.30	28	5	188	1	0.045	10.5
MM3Z16VB	LZ	15.68	16	16.32	37	5	188	1	0.045	11.2
MM3Z18VB	MZ	17.64	18	18.36	42	5	212	1	0.045	12.6
MM3Z20VB	NZ	19.60	20	20.40	51	5	212	1	0.045	14.0
MM3Z22VB	PZ	21.56	22	22.44	51	5	235	1	0.045	15.4
MM3Z24VB	RZ	23.52	24	24.48	65	5	235	1	0.045	16.8
MM3Z27VB	SZ	26.46	27	27.54	75	2	282	0.5	0.045	18.9
MM3Z30VB	TZ	29.40	30	30.60	75	2	282	0.5	0.045	21.0
MM3Z33VB	UZ	32.34	33	33.66	75	2	306	0.5	0.045	23.0
MM3Z36VB	VZ	35.28	36	36.72	84	2	329	0.5	0.045	25.2
MM3Z39VB	WZ	38.22	39	39.78	122	2	329	0.5	0.045	27.3
MM3Z43VB	XZ	42.14	43	43.86	141	2	353	0.5	0.045	30.1
MM3Z47VB	YZ	46.06	47	47.94	160	2	353	0.5	0.045	33.0
MM3Z51VB	_Z	49.98	51	52.02	169	2	376	0.5	0.045	35.7
MM3Z56VB	=Z	54.88	56	57.12	188	2	400	0.5	0.045	39.2
MM3Z62VB	≡Z	60.76	62	63.24	202	2	423	0.5	0.045	43.4
MM3Z68VB	>Z	66.64	68	69.36	226	2	447	0.5	0.045	47.6
MM3Z75VB	<Z	73.5	75	76.50	240	2	470	0.5	0.045	52.5

Notes :

1. The Zener Voltage (V_Z) is tested under pulse condition of 10mS.
2. The device numbers listed have a standard tolerance on the nominal zener voltage of $\pm 2\%$.
3. The zener impedance is derived from the 60-cycle ac voltage, which results when an ac current having an rms value equal to 10% of the dc zener current (I_{ZT} or I_{ZK}) is superimposed to I_{ZT} or I_{ZK} .

Typical Performance Characteristics

Figure 1. Zener current vs. Zener Voltage

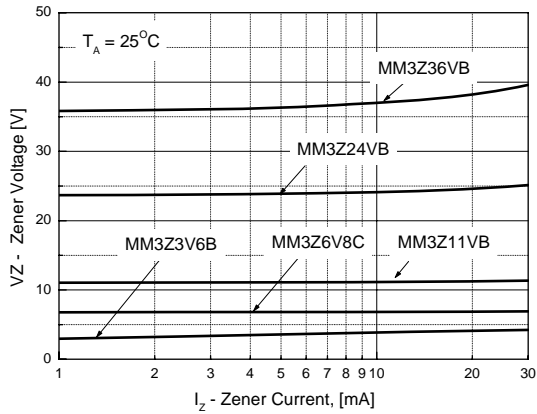

Figure 2. Zener current vs. Zener Impedance

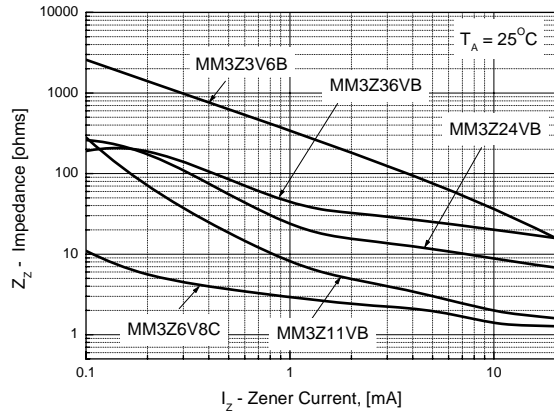

Figure 3. MM3Z3V6B
Zener current vs. Zener Voltage

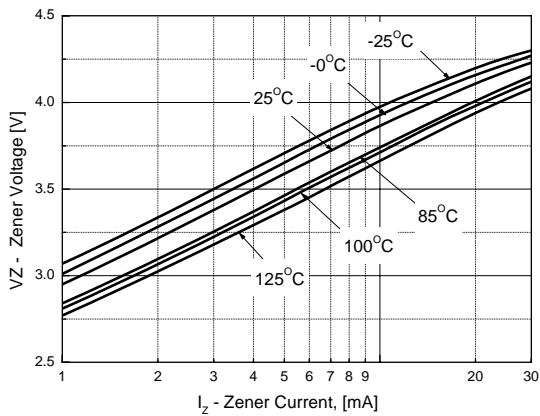

Figure 4. MM3Z6V8C
Zener current vs. Zener Voltage

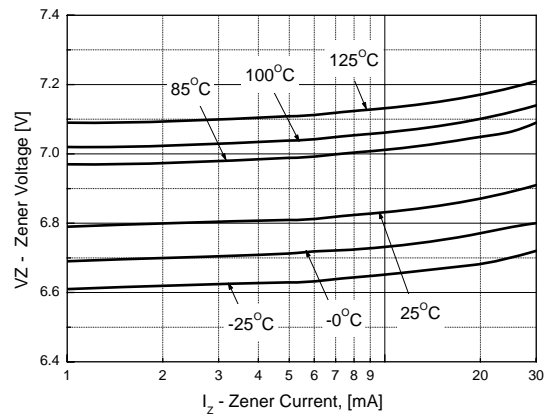

Figure 5. MM3Z11VB
Zener current vs. Zener Voltage

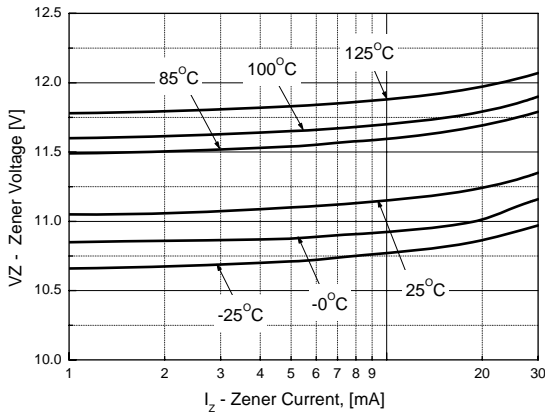
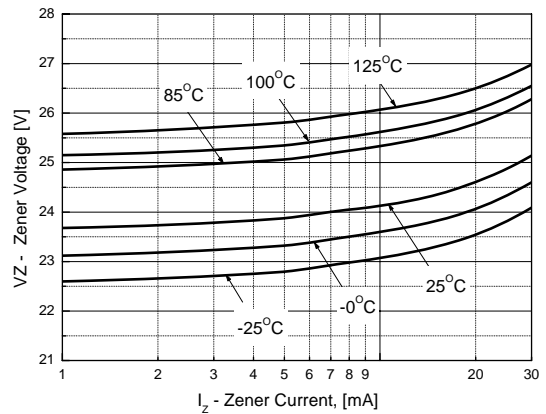
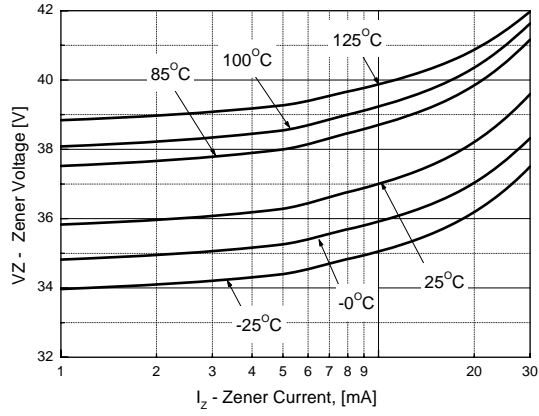

Figure 6. MM3Z24VB
Zener current vs. Zener Voltage



Typical Performance Characteristics (Continued)

Figure 7. MM3Z36VB
Zener current vs. Zener Voltage



Physical Dimensions

SOD-323F

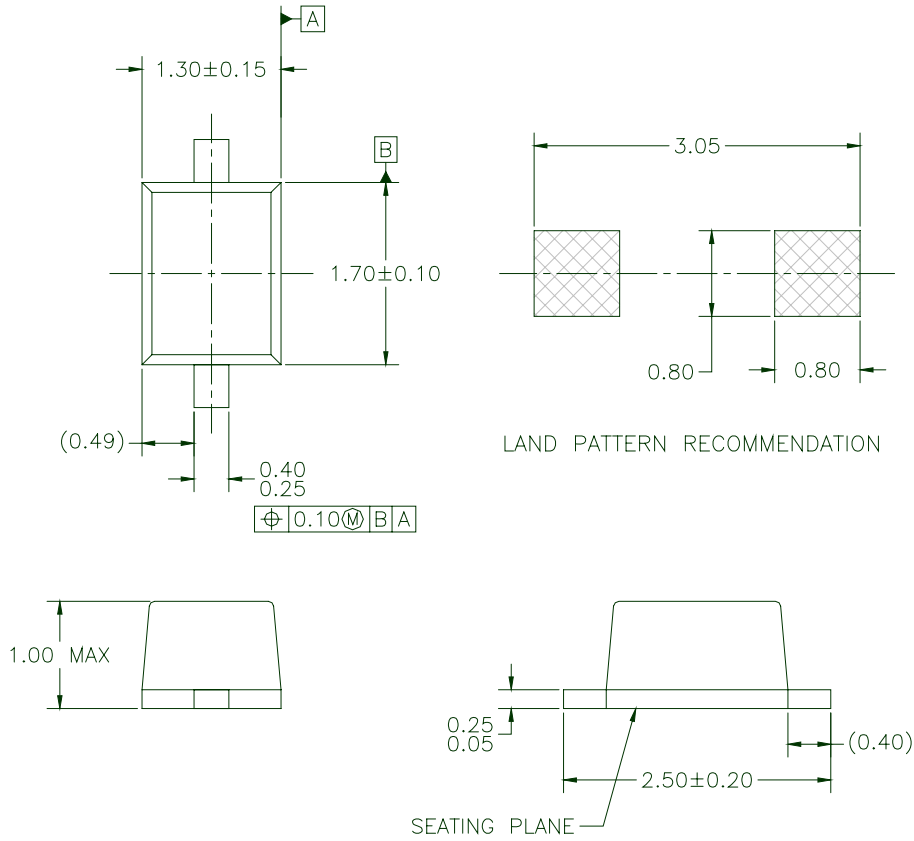

NOTES: UNLESS OTHERWISE SPECIFIED

- A) THIS PACKAGE IS COMPLIANT TO JEITA SC90 STANDARD EXCEPT FOR THE OVERALL PACKAGE HEIGHT.
- B) ALL DIMENSIONS ARE IN MILLIMETERS.
- C) DIMENSIONS ARE EXCLUSIVE OF BURRS, MOLD FLASH AND TIE BAR EXTRUSIONS.
- D) DIMENSIONING AND TOLERANCING PER ASME Y14.5M - 1994.

Dimensions in Millimeters



TRADEMARKS

The following includes registered and unregistered trademarks and service marks, owned by Fairchild Semiconductor and/or its global subsidiaries, and is not intended to be an exhaustive list of all such trademarks.

AccuPower™	F-PFS™	Power-SPM™	<p>SYSTEM GENERAL® The Power Franchise® the power franchise TinyBoost™ TinyBuck™ TinyCalc™ TinyLogic® TINYOPTO™ TinyPower™ TinyPWM™ TinyWire™ TriFault Detect™ TRUECURRENT™* µSerDes™ µSerDes™ UHC® Ultra FRFET™ UniFET™ VCX™ VisualMax™ XS™</p>
Auto-SPM™	FRFET®	PowerTrench®	
Build it Now™	Global Power Resource SM	PowerXST™	
CorePLUS™	Green FPS™	Programmable Active Droop™	
CorePOWER™	Green FPS™ e-Series™	QFET®	
CROSSVOLT™	Gmax™	QS™	
CTL™	GTO™	Quiet Series™	
Current Transfer Logic™	IntelliMAX™	RapidConfigure™	
DEUXPEED®	ISOPLANAR™	Saving our world, 1mW/W/kW at a time™	
Dual Cool™	MegaBuck™	SignalWise™	
EcoSPARK®	MICROCOUPLER™	SmartMax™	
EfficientMax™	MicroFET™	SMART START™	
ESBC™	MicroPak™	SPM®	
Fairchild®	MicroPak2™	STEALTH™	
Fairchild Semiconductor®	MillerDrive™	SuperFET®	
FACT Quiet Series™	MotionMax™	SuperSOT™-3	
FACT®	Motion-SPM™	SuperSOT™-6	
FAST®	OptoHiT™	SuperSOT™-8	
FastvCore™	OPTOLOGIC®	SupreMOS®	
FETBench™	OPTOPLANAR®	SyncFET™	
FlashWriter®*	PDP SPM™	Sync-Lock™	
FPS™			

* Trademarks of System General Corporation, used under license by Fairchild Semiconductor.

DISCLAIMER

FAIRCHILD SEMICONDUCTOR RESERVES THE RIGHT TO MAKE CHANGES WITHOUT FURTHER NOTICE TO ANY PRODUCTS HEREIN TO IMPROVE RELIABILITY, FUNCTION, OR DESIGN. FAIRCHILD DOES NOT ASSUME ANY LIABILITY ARISING OUT OF THE APPLICATION OR USE OF ANY PRODUCT OR CIRCUIT DESCRIBED HEREIN; NEITHER DOES IT CONVEY ANY LICENSE UNDER ITS PATENT RIGHTS, NOR THE RIGHTS OF OTHERS. THESE SPECIFICATIONS DO NOT EXPAND THE TERMS OF FAIRCHILD'S WORLDWIDE TERMS AND CONDITIONS, SPECIFICALLY THE WARRANTY THEREIN, WHICH COVERS THESE PRODUCTS.

LIFE SUPPORT POLICY

FAIRCHILD'S PRODUCTS ARE NOT AUTHORIZED FOR USE AS CRITICAL COMPONENTS IN LIFE SUPPORT DEVICES OR SYSTEMS WITHOUT THE EXPRESS WRITTEN APPROVAL OF FAIRCHILD SEMICONDUCTOR CORPORATION.

As used herein:

1. Life support devices or systems are devices or systems which, (a) are intended for surgical implant into the body or (b) support or sustain life, and (c) whose failure to perform when properly used in accordance with instructions for use provided in the labeling, can be reasonably expected to result in a significant injury of the user.
2. A critical component in any component of a life support, device, or system whose failure to perform can be reasonably expected to cause the failure of the life support device or system, or to affect its safety or effectiveness.

ANTI-COUNTERFEITING POLICY

Fairchild Semiconductor Corporation's Anti-Counterfeiting Policy. Fairchild's Anti-Counterfeiting Policy is also stated on our external website, www.fairchildsemi.com, under Sales Support.

Counterfeiting of semiconductor parts is a growing problem in the industry. All manufacturers of semiconductor products are experiencing counterfeiting of their parts. Customers who inadvertently purchase counterfeit parts experience many problems such as loss of brand reputation, substandard performance, failed applications, and increased cost of production and manufacturing delays. Fairchild is taking strong measures to protect ourselves and our customers from the proliferation of counterfeit parts. Fairchild strongly encourages customers to purchase Fairchild parts either directly from Fairchild or from Authorized Fairchild Distributors who are listed by country on our web page cited above. Products customers buy either from Fairchild directly or from Authorized Fairchild Distributors are genuine parts, have full traceability, meet Fairchild's quality standards for handling and storage and provide access to Fairchild's full range of up-to-date technical and product information. Fairchild and our Authorized Distributors will stand behind all warranties and will appropriately address any warranty issues that may arise. Fairchild will not provide any warranty coverage or other assistance for parts bought from Unauthorized Sources. Fairchild is committed to combat this global problem and encourage our customers to do their part in stopping this practice by buying direct or from authorized distributors.

PRODUCT STATUS DEFINITIONS

Definition of Terms

Datasheet Identification	Product Status	Definition
Advance Information	Formative / In Design	Datasheet contains the design specifications for product development. Specifications may change in any manner without notice.
Preliminary	First Production	Datasheet contains preliminary data; supplementary data will be published at a later date. Fairchild Semiconductor reserves the right to make changes at any time without notice to improve design.
No Identification Needed	Full Production	Datasheet contains final specifications. Fairchild Semiconductor reserves the right to make changes at any time without notice to improve the design.
Obsolete	Not In Production	Datasheet contains specifications on a product that is discontinued by Fairchild Semiconductor. The datasheet is for reference information only.