

STANDARD RECOVERY DIODES

Stud Version

Features

- Wide current range
- High voltage ratings up to 3200V
- High surge current capabilities
- Stud cathode and stud anode version
- Standard JEDEC types

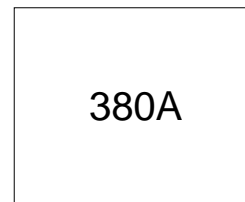

Typical Applications

- Converters
- Power supplies
- Machine tool controls
- High power drives
- Medium traction applications

Major Ratings and Characteristics

Parameters	SD300N/R		Units
	16 to 20	25 to 32	
$I_{F(AV)}$	380	380	A
@ T_C	100	70	°C
$I_{F(RMS)}$	595	425	A
I_{FSM} @ 50Hz	6050	6050	A
@ 60Hz	6335	6335	A
I^2t @ 50Hz	183	183	KA ² s
@ 60Hz	167	167	KA ² s
V_{RRM} range	1600 to 2000	2500 to 3200	V
T_J	- 40 to 180	- 40 to 150	°C

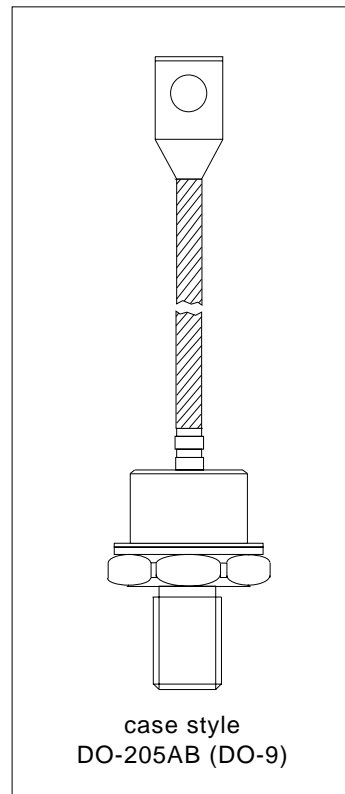

ELECTRICAL SPECIFICATIONS

Voltage Ratings

Type number	Voltage Code	V_{RRM} , maximum repetitive peak reverse voltage V	V_{RSM} , maximum non-repetitive peak rev. voltage V	I_{RRM} max. @ $T_J = T_J$ max. mA
SD300N/R	16	1600	1700	15
	20	2000	2100	
	25	2500	2600	
	28	2800	2900	
	32	3200	3300	

Forward Conduction

Parameter	SD300N/R		Units	Conditions		
	16 to 20	25 to 32				
$I_{F(AV)}$ Max. average forward current @ Case temperature	380	270	A	180° conduction, half sine wave		
	100	100	°C			
$I_{F(AV)}$ Max. average forward current @ Case temperature	300	380	A	180° conduction, half sine wave		
	125	70	°C			
$I_{F(RMS)}$ Max. RMS forward current	595	425	A	DC @ $T_C = 88^\circ\text{C}$ (02 to 24), $T_C = 91^\circ\text{C}$ (25 to 32)		
I_{FSM} Max. peak, one-cycle forward, non-repetitive surge current	6050	6050	A	t = 10ms	No voltage	Sinusoidal half wave, Initial $T_J = T_J$ max.
	6335	6335		t = 8.3ms	reapplied	
	5090	5090		t = 10ms	100% V_{RRM}	
	5330	5330		t = 8.3ms	reapplied	
I^2t Maximum I^2t for fusing	183	183	KA ² s	t = 10ms	No voltage	
	167	167		t = 8.3ms	reapplied	
	129	129		t = 10ms	100% V_{RRM}	
	118	118		t = 8.3ms	reapplied	
I^2/\sqrt{t} Maximum I^2/\sqrt{t} for fusing	1830	1830	KA ² /s	t = 0.1 to 10ms, no voltage reapplied		
$V_{F(TO)1}$ Low level value of threshold voltage	0.95	0.95	V	(16.7% $\times \pi \times I_{F(AV)} < I < \pi \times I_{F(AV)}$), $T_J = T_J$ max.		
$V_{F(TO)2}$ High level value of threshold voltage	1.05	1.05		(I $> \pi \times I_{F(AV)}$), $T_J = T_J$ max.		
r_{f1} Low level value of forward slope resistance	0.75	0.75	mΩ	(16.7% $\times \pi \times I_{F(AV)} < I < \pi \times I_{F(AV)}$), $T_J = T_J$ max.		
r_{f2} High level value of forward slope resistance	0.66	0.66		(I $> \pi \times I_{F(AV)}$), $T_J = T_J$ max.		
V_{FM} Max. forward voltage drop	1.83	1.83	V	$I_{pk} = 1180\text{A}$, $T_J = T_J$ max, $t_p = 10\text{ms}$ sinusoidal wave		

Thermal and Mechanical Specifications

Parameter	SD300N/R		Units	Conditions
	16 to 20	25 to 32		
T _J Max. junction operating temperature range	-40 to 180	-40 to 150	°C	
T _{stg} Max. storage temperature range	-55 to 200	-55 to 200		
R _{thJC} Max. thermal resistance, junction to case	0.11		K/W	DC operation
R _{thCS} Max. thermal resistance, case to heatsink	0.04			Mounting surface, smooth, flat and greased
T Max. allowed mounting torque ±10%	27		Nm	Not lubricated threads
wt Approximate weight	250		g	
Case style	DO-205AB (DO-9)			See Outline Table

ΔR_{thJC} Conduction

(The following table shows the increment of thermal resistance R_{thJC} when devices operate at different conduction angles than DC)

Conduction angle	Sinusoidal conduction		Rectangular conduction		Units	Conditions
	16 to 20	25 to 32	16 to 20	25 to 32		
180°	0.019	0.019	0.013	0.013	K/W	T _J = T _J max.
120°	0.023	0.023	0.023	0.023		
90°	0.028	0.028	0.030	0.030		
60°	0.042	0.042	0.044	0.044		
30°	0.073	0.073	0.074	0.074		

Ordering Information Table

Device Code

SD	30	0	N	32	P	C
1	2	3	4	5	6	7

- 1** - Diode
- 2** - Essential part number
- 3** - 0 = Standard recovery
- 4** - N = Stud Normal Polarity (Cathode to Stud)
R = Stud Reverse Polarity (Anode to Stud)
- 5** - Voltage code: Code x 100 = V_{RRM} (See Voltage Ratings table)
- 6** - P = Stud base DO-205AB (DO-9) 3/4" 16UNF-2A
- 7** - C = Ceramic Housing

NOTE: For metric Device M16 x 1.5 Contact Factory

SD300N/R Series

Bulletin I2081 rev. C 03/03

Outline Table

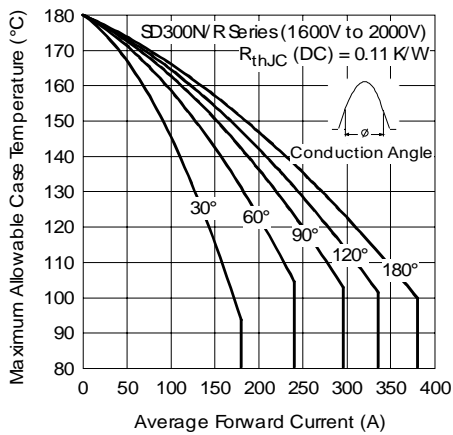
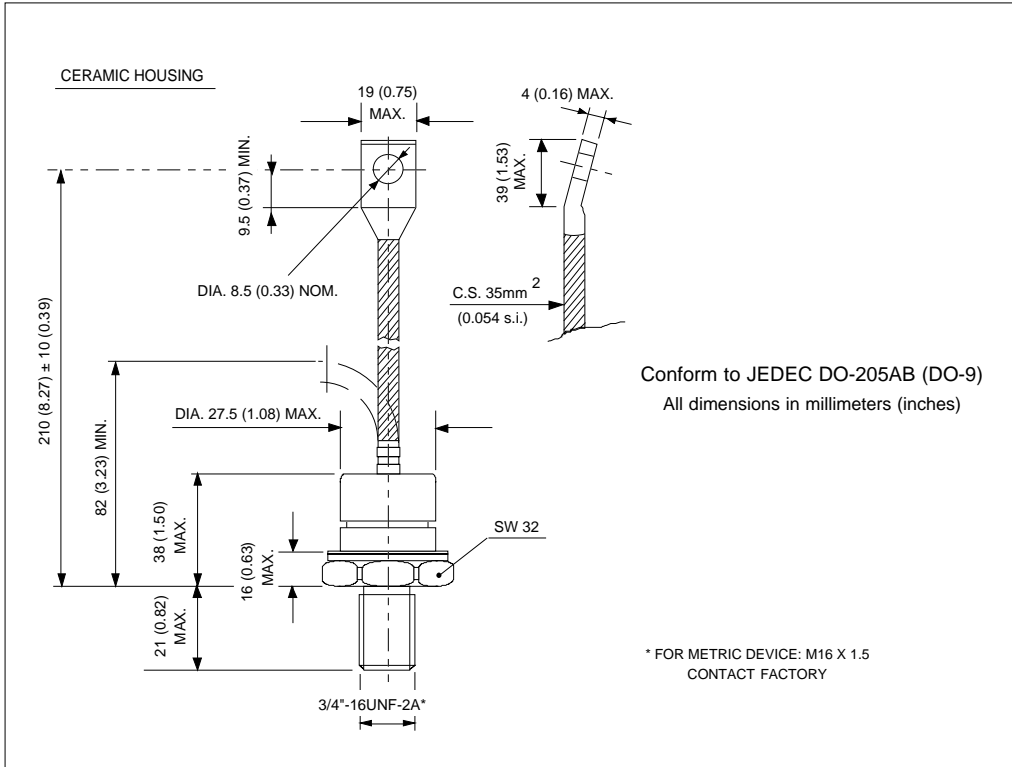

Fig. 1 - Current Ratings Characteristics

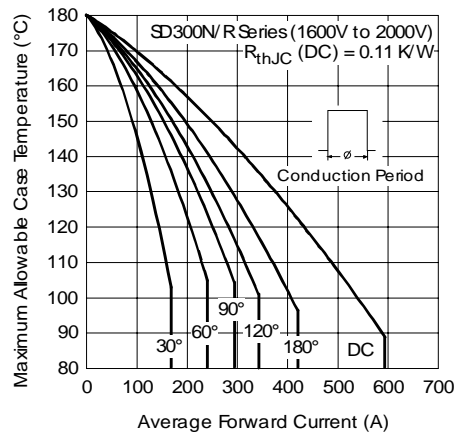

Fig. 2 - Current Ratings Characteristics

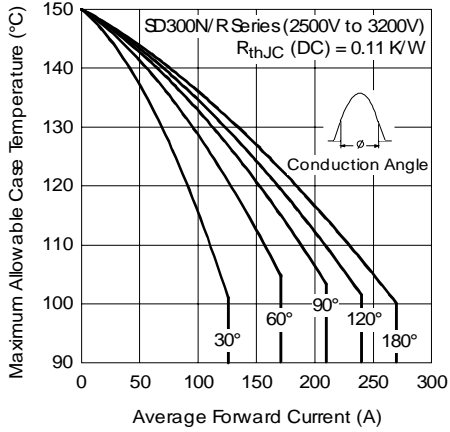

Fig. 3 - Current Ratings Characteristics

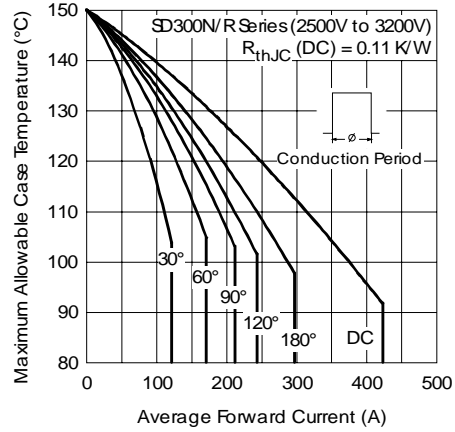

Fig. 4 - Current Ratings Characteristics

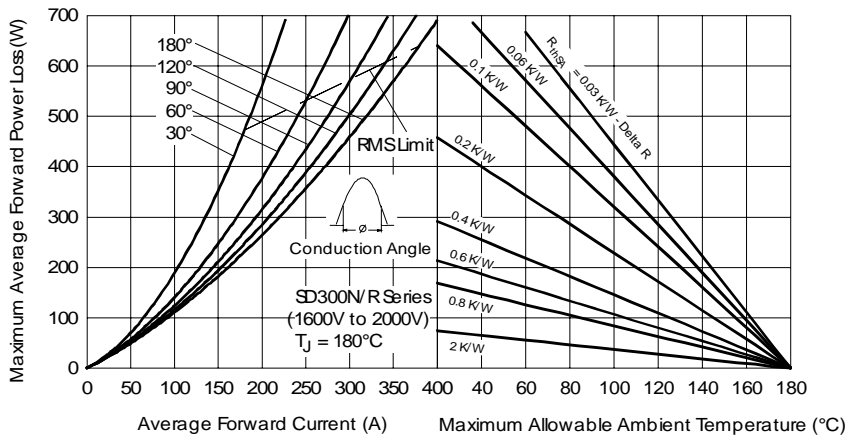

Fig. 5 - Forward Power Loss Characteristics

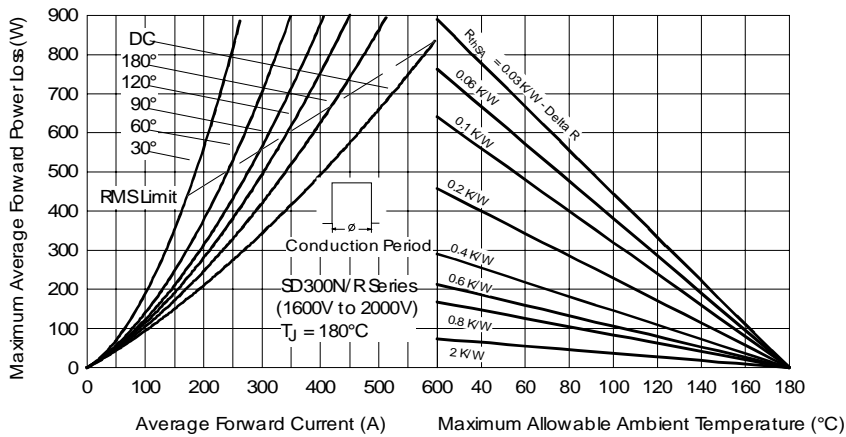

Fig. 6 - Forward Power Loss Characteristics

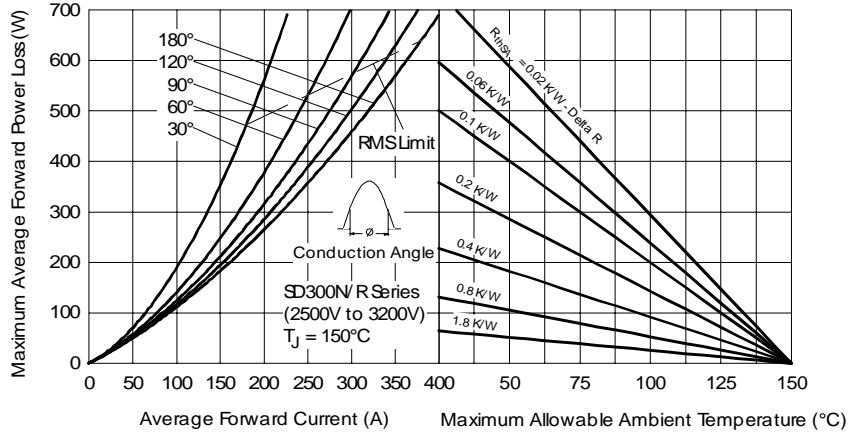

Fig. 7 - Forward Power Loss Characteristics

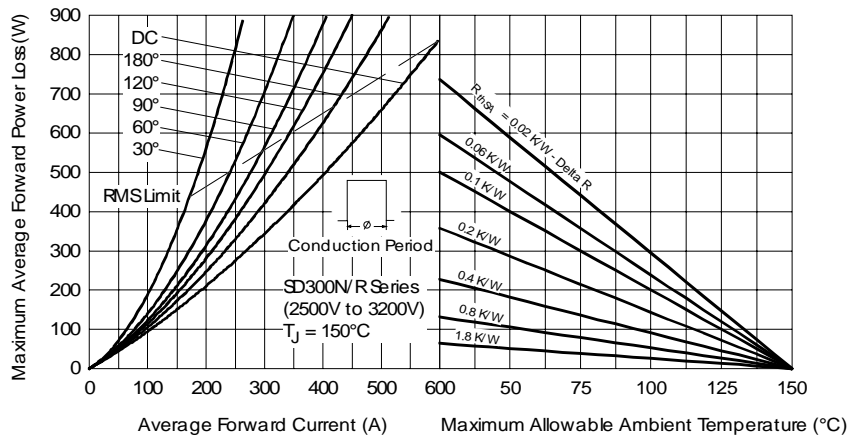

Fig. 8 - Forward Power Loss Characteristics

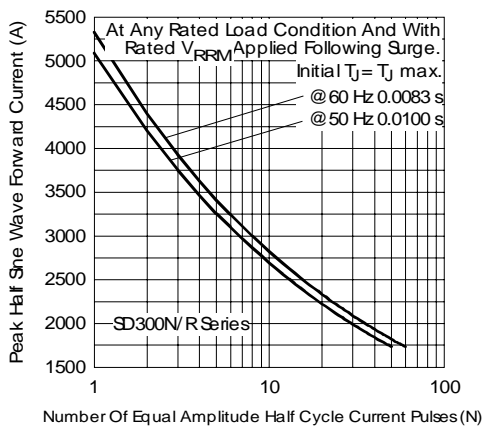

Fig. 9 - Maximum Non-Repetitive Surge Current

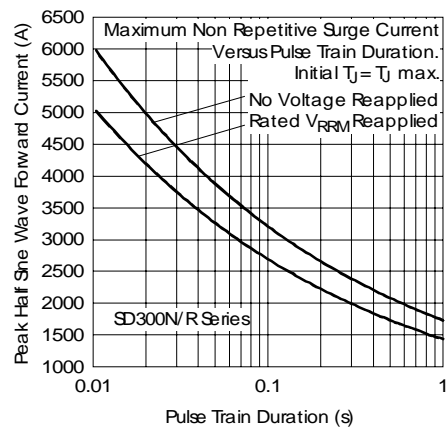

Fig. 10 - Maximum Non-Repetitive Surge Current

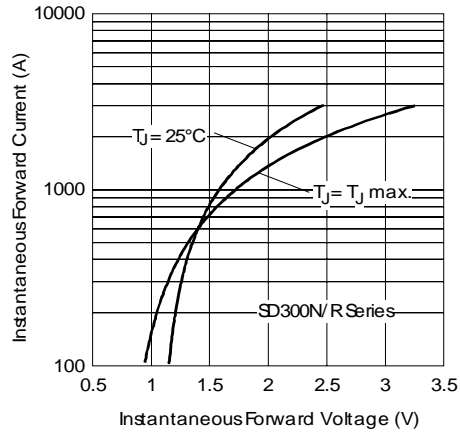

Fig. 11 - Forward Voltage Drop Characteristics

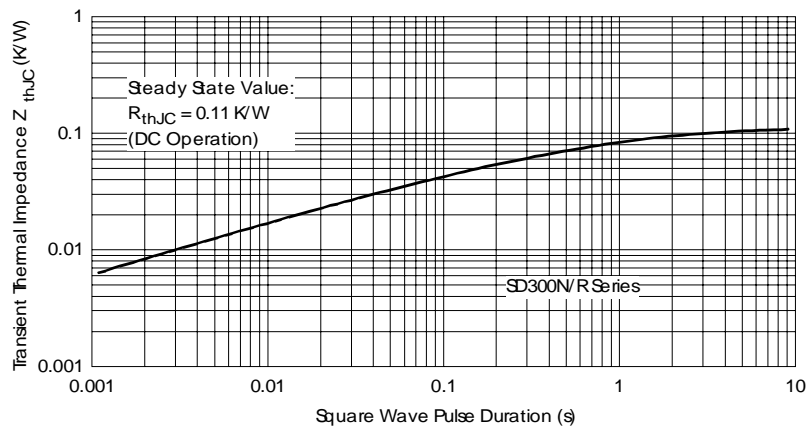

Fig. 12 - Thermal Impedance Z_{thJC} Characteristics

Data and specifications subject to change without notice.
 This product has been designed and qualified for Industrial Level.
 Qualification Standards can be found on IR's Web site.