



LOW DROP OR-ing POWER SCHOTTKY RECTIFIERS

MAIN PRODUCT CHARACTERISTICS

$I_{F(AV)}$	20 A
V_{RRM}	15 V
V_F (max)	0.33 V

FEATURES AND BENEFITS

- VERY LOW FORWARD VOLTAGE DROP FOR LESS POWER DISSIPATION AND REDUCED HEATSINK SIZE
- REVERSE VOLTAGE SUITED TO OR-RING OF 3V, 5V and 12V RAILS

DESCRIPTION

Packaged in TO-220AC or D²PAK, this device is especially intended for use as an OR-ing diode in fault tolerant power supplies equipment.

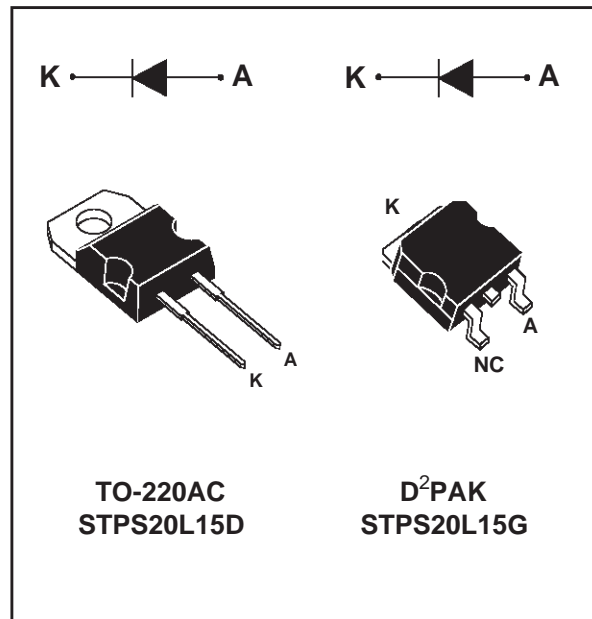

ABSOLUTE RATINGS (limiting values)

Symbol	Parameter		Value	Unit
V_{RRM}	Repetitive peak reverse voltage		15	V
$I_{F(RMS)}$	RMS forward current		30	A
$I_{F(AV)}$	Average forward current	$T_C = 85^\circ\text{C}$ $\delta = 0.5$ $V_R = 15\text{V}$	20	A
I_{FSM}	Surge non repetitive forward current	$t_p = 10\text{ ms}$ Sinusoidal	310	A
I_{RRM}	Repetitive peak reverse current	$t_p = 2\ \mu\text{s}$ $F = 1\text{ kHz}$	2	A
I_{RSM}	Non repetitive peak reverse current	$t_p = 100\ \mu\text{s}$	3	A
E_{as}	Non repetitive avalanche energy	$T_a = 25^\circ\text{C}$ $I_{as} = 2\text{ A}$ $L = 6\text{ mH}$	9	mJ
I_{ar}	Repetitive avalanche current	- $V_a = 3x\ V_R$ typ. - Current decaying linearly to 0 in $1\ \mu\text{s}$ - frequency limited by T_j max	2	A
T_{stg}	Storage temperature range		- 65 to + 150	$^\circ\text{C}$
T_j	Maximum junction temperature		125	
dV/dt	Critical rate of rise of reverse voltage		10000	$\text{V}/\mu\text{s}$

STPS20L15D/G

THERMAL RESISTANCES

Symbol	Parameter	Value	Unit
$R_{th(j-c)}$	Junction to case	1.6	$^{\circ}\text{C}/\text{W}$

STATIC ELECTRICAL CHARACTERISTICS (Per Diode)

Symbol	Tests Conditions	Tests Conditions	Min.	Typ.	Max.	Unit	
I_R^*	Reverse leakage current	$T_j = 25^{\circ}\text{C}$	$V_R = 15\text{V}$		6	mA	
		$T_j = 100^{\circ}\text{C}$	$V_R = 15\text{V}$		200		670
V_F^*	Forward voltage drop	$T_j = 25^{\circ}\text{C}$	$I_F = 19\text{A}$			0.41	V
		$T_j = 25^{\circ}\text{C}$	$I_F = 40\text{A}$			0.52	
		$T_j = 125^{\circ}\text{C}$	$I_F = 19\text{A}$		0.28	0.33	
		$T_j = 125^{\circ}\text{C}$	$I_F = 40\text{A}$		0.42	0.50	

Pulse test : * $t_p = 380\ \mu\text{s}$, $\delta < 2\%$

To evaluate the maximum conduction losses use the following equation :

$$P = 0.19 \times I_{F(AV)} + 8.5 \cdot 10^{-3} \times I_{F(RMS)}^2$$

Fig. 1: Average forward power dissipation versus average forward current.

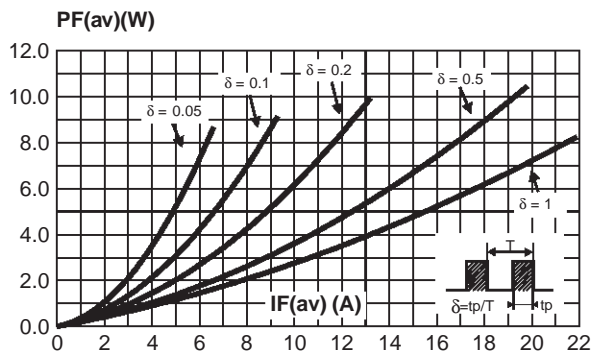

Fig. 2: Average forward current versus ambient temperature ($\delta = 0.5$).

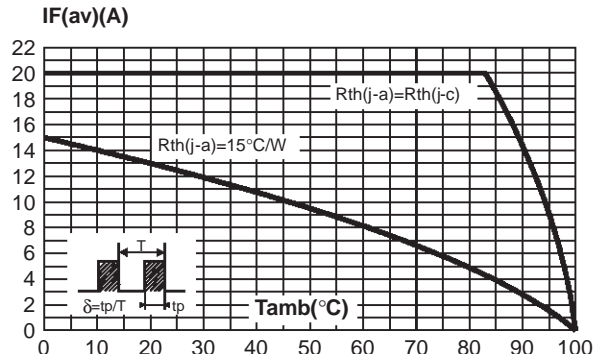

Fig. 3: Non repetitive surge peak forward current versus overload duration (maximum values).

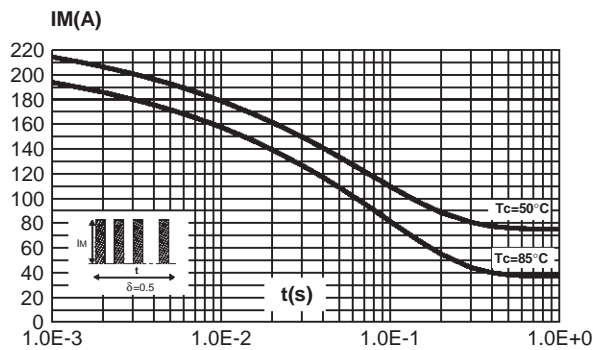

Fig. 4: Relative variation of thermal impedance junction to case versus pulse duration.

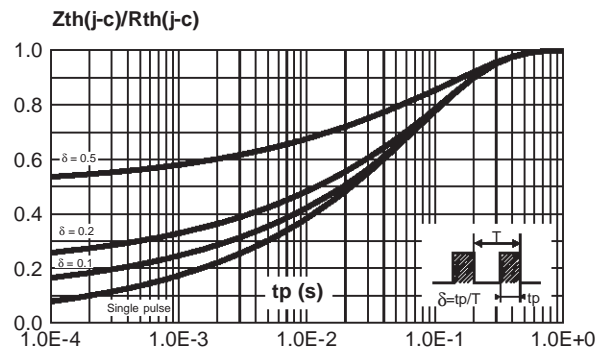

Fig. 5: Reverse leakage current versus reverse voltage applied (typical values).

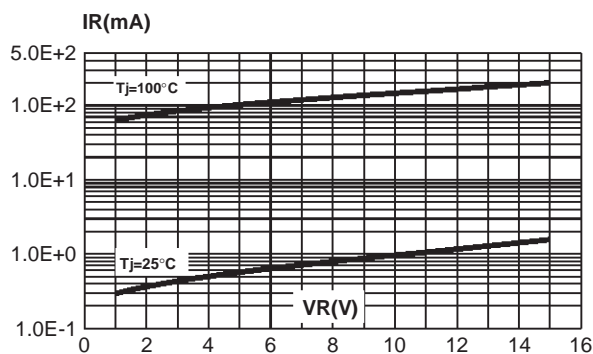

Fig. 6: Junction capacitance versus reverse voltage applied (typical values).

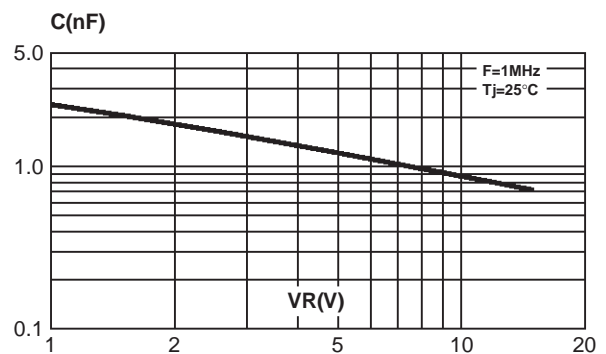

Fig. 7: Forward voltage drop versus forward current (maximum values).

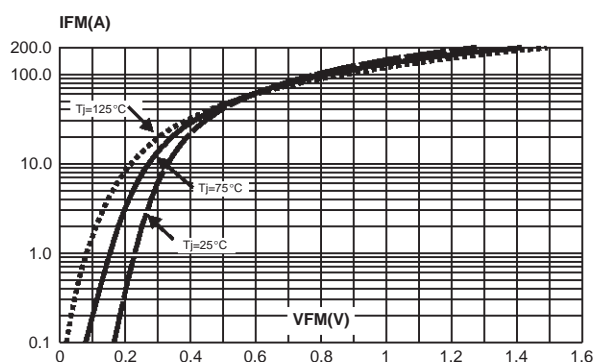
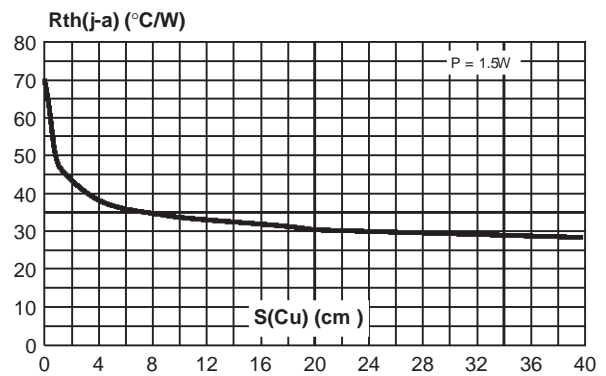
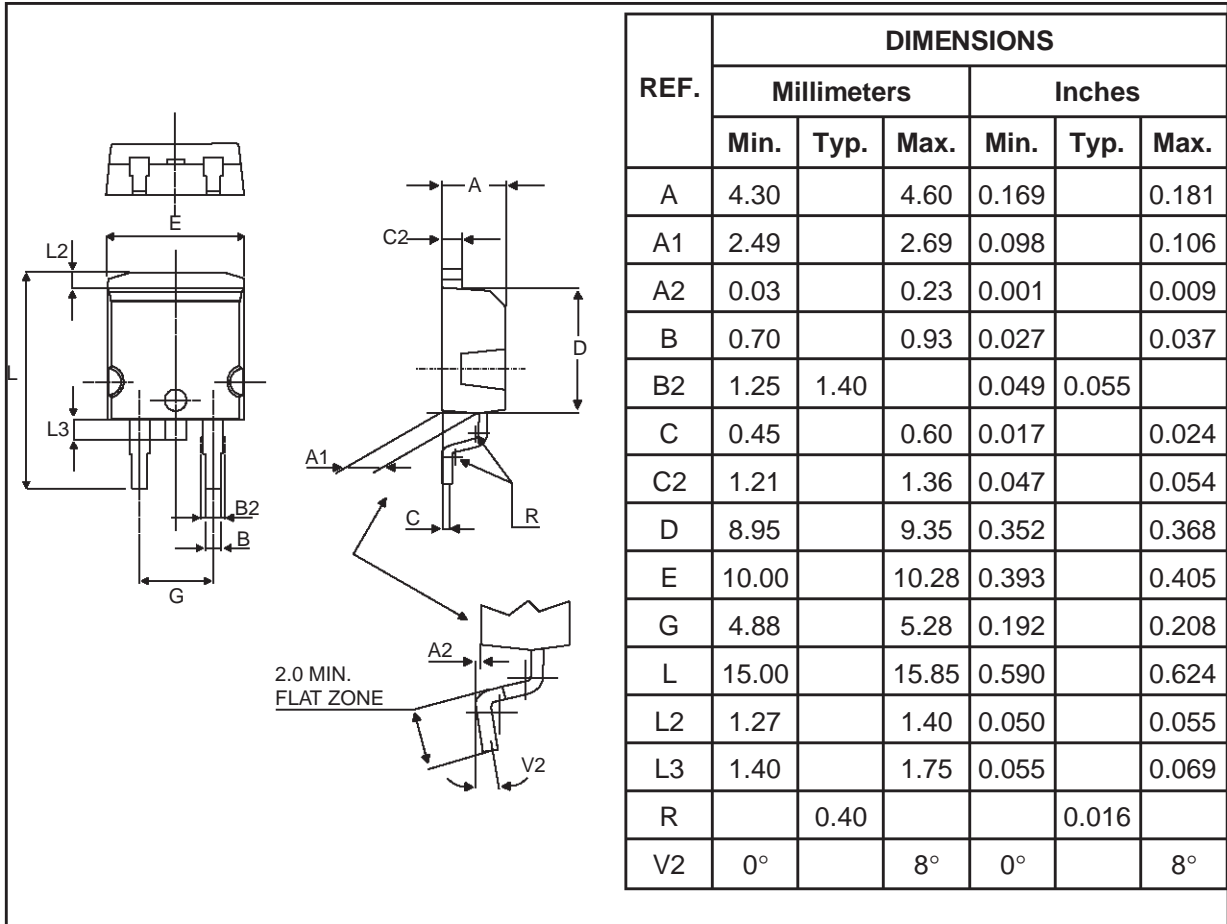

Fig. 8: Thermal resistance junction to ambient versus copper surface under tab (Epoxy printed circuit board FR4, copper thickness : 35 μm). (STPS20L15G only)



STPS20L15D/G

PACKAGE MECHANICAL DATA D²PAK



FOOT PRINT DIMENSIONS (in millimeters)

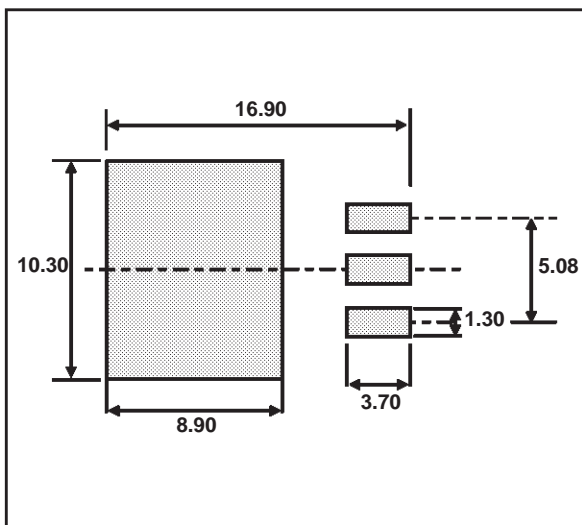

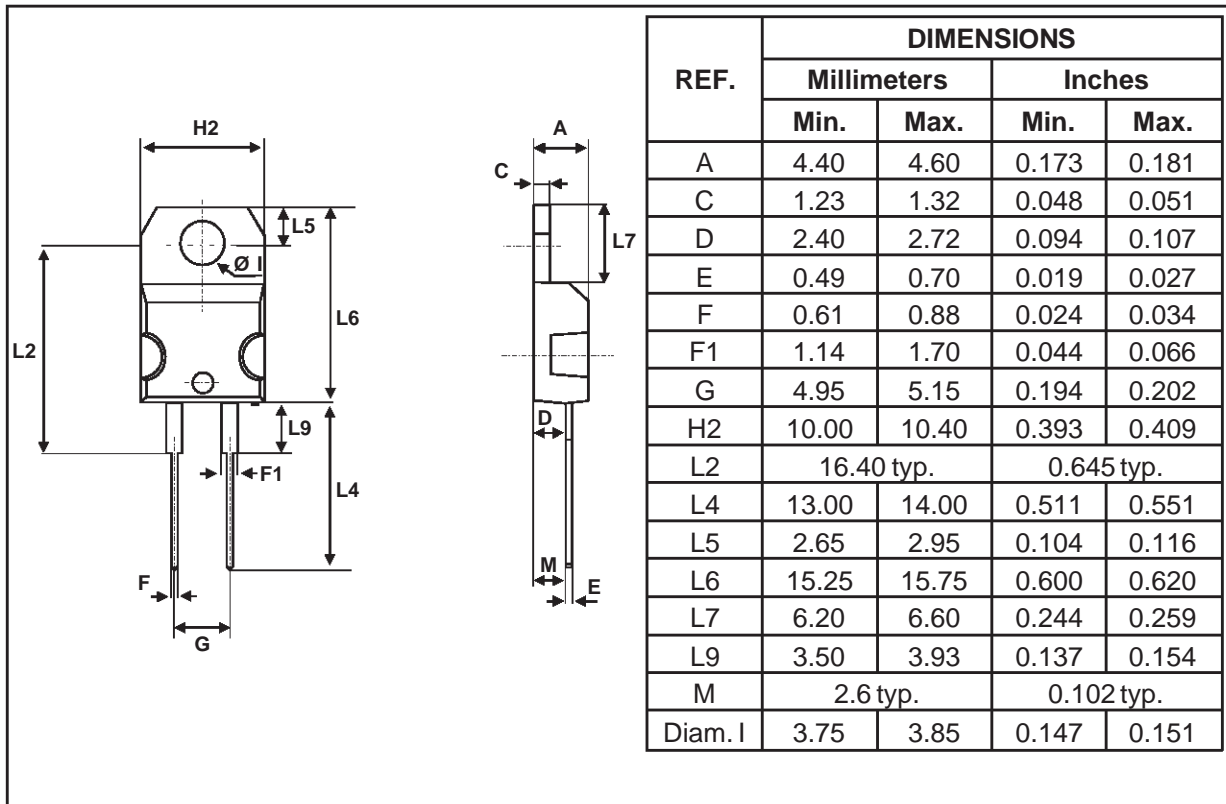
PACKAGE MECHANICAL DATA
 TO-220AC

Information furnished is believed to be accurate and reliable. However, STMicroelectronics assumes no responsibility for the consequences of use of such information nor for any infringement of patents or other rights of third parties which may result from its use. No license is granted by implication or otherwise under any patent or patent rights of STMicroelectronics. Specifications mentioned in this publication are subject to change without notice. This publication supersedes and replaces all information previously supplied. STMicroelectronics products are not authorized for use as critical components in life support devices or systems without express written approval of STMicroelectronics.

The ST logo is a registered trademark of STMicroelectronics

© 1998 STMicroelectronics - Printed in Italy - All rights reserved.

STMicroelectronics GROUP OF COMPANIES

Australia - Brazil - Canada - China - France - Germany - Italy - Japan - Korea - Malaysia - Malta - Mexico - Morocco -
 The Netherlands - Singapore - Spain - Sweden - Switzerland - Taiwan - Thailand - United Kingdom - U.S.A.

<http://www.st.com>