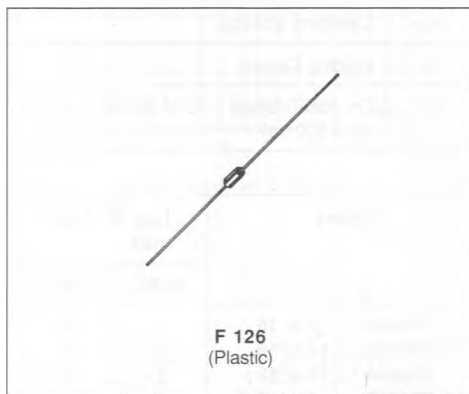

- BIDIRECTIONAL DEVICE USED TO **TELEPHONE PROTECTION**
- CHARACTERISTIC OF STAND-OFF AND BREAKDOWN VOLTAGE SIMILAR TO A TRANSIL (V_{off})
- HIGH FLOWOUT CAPABILITY BECAUSE OF ITS BREAKOVER CHARACTERISTIC (V_{on})

ABSOLUTE RATINGS (limiting values) ($T_J = 25\text{ }^\circ\text{C}$ - $L = 10\text{ mm}$)

Symbol	Parameter		Value	Unit
P	Power Dissipation on Infinite Heatsink	$T_{amb} = 50\text{ }^\circ\text{C}$	1.7	W
I_{pp}	Peak Pulse Current	1 ms expo	50	A
		8-20 μs expo	100	
I_{TSM}	Non Repetitive Surge Peak on-state Current	$t_p = 20\text{ ms}$	30	A
di/dt	Critical Rate of Rise of on-state Current	Non Repetitive	100	A/ μs
dv/dt	Critical Rate of Rise of off-state Voltage	67 % $V_{(BR)}$ min	5	kV/ μs
T_{stg} T_J	Storage and Operating Junction Temperature Range		- 40 to 150	$^\circ\text{C}$
			150	$^\circ\text{C}$
T_L	Maximum Lead Temperature for Soldering During 10 s at 4 mm from Case		230	$^\circ\text{C}$

THERMAL RESISTANCES

Symbol	Parameter		Value	Unit
$R_{th(j-l)}$	Junction-leads on Infinite Heatsink	$L = 10\text{ mm}$	60	$^\circ\text{C/W}$
$R_{th(j-a)}$	Junction-ambient on Printed Circuit		100	$^\circ\text{C/W}$

ELECTRICAL CHARACTERISTICS
($T_j = 25\text{ }^\circ\text{C}$)

Symbol	Parameter
V_{RM}	Stand-off Voltage
V_{BR}	Breakdown Voltage
V_{BO}	Clamping Voltage
I_H	Holding Current
V_T	On-state Voltage : 2.5 V typ. @ $I_T = 1\text{ A}$ ($t_p = 300\text{ }\mu\text{s}$)

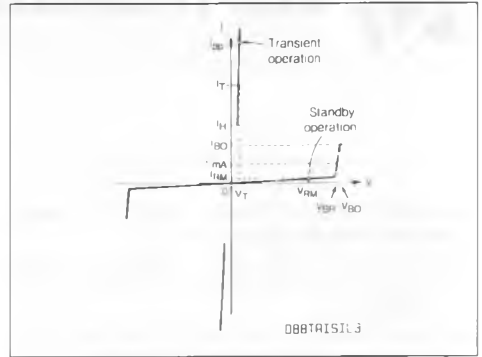

Types	I_{RM} @ V_{RM} max.		$V_{(BR)}$ @ I_R min.		V_{BO} max.	I_{BO} max.	I_H min.
	(μA)	(V)	(V)	(mA)	(V)	(mA)	(mA)
TPA62A - 12 or 18	2	56	62	1	82	800	12 Suffix for 120 mA
(1) TPA62B - 12 or 18	2	56	62	1	75	800	
TPA68A - 12 or 18	2	61	68	1	90	800	
(1) TPA68B - 12 or 18	2	61	68	1	82	800	
(1) TPA75A - 12 or 18	2	67	75	1	100	800	
(1) TPA75B - 12 or 18	2	67	75	1	91	800	
(1) TPA82A - 12 or 18	2	74	82	1	109	300	
(1) TPA82B - 12 or 18	2	74	82	1	99	300	
(1) TPA91A - 12 or 18	2	82	91	1	121	300	
(1) TPA91B - 12 or 18	2	82	91	1	110	300	
P TPA100A - 12 or 18	2	90	100	1	133	300	
TPA100B - 12 or 18	2	90	100	1	121	300	
TPA110A - 12 or 18	2	99	110	1	147	300	
TPA110B - 12 or 18	2	99	110	1	133	300	
P TPA120A - 12 or 18	2	108	120	1	160	300	
TPA120B - 12 or 18	2	108	120	1	145	300	
P TPA130A - 12 or 18	2	117	130	1	173	300	
TPA130B - 12 or 18	2	117	130	1	157	300	
(1) TPA150A - 12 or 18	2	135	150	1	200	300	
(1) TPA150B - 12 or 18	2	135	150	1	181	300	
(1) TPA160A - 12 or 18	2	144	160	1	213	300	
(1) TPA160B - 12 or 18	2	144	160	1	193	300	
(1) TPA180A - 12 or 18	2	162	180	1	240	300	
(1) TPA180B - 12 or 18	2	162	180	1	217	300	
(1) TPA200A - 12 or 18	2	180	200	1	267	300	
(1) TPA200B - 12 or 18	2	180	200	1	241	300	
P TPA220A - 12 or 18	2	198	220	1	293	300	
TPA220B - 12 or 18	2	198	220	1	265	300	
P TPA240A - 12 or 18	2	216	240	1	320	300	
TPA240B - 12 or 18	2	216	240	1	289	300	
P TPA270A - 12 or 18	2	243	270	1	360	300	
TPA270B - 12 or 18	2	243	270	1	325	300	

P : Preferred device.
(1) : These volages are on request. Consult us.

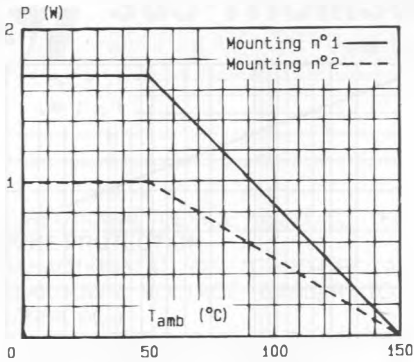

Fig.1 - Power dissipation versus ambient temperature.

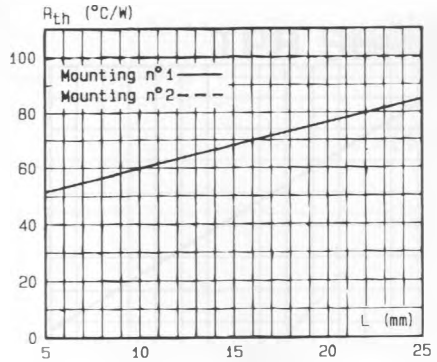

Fig.2 - Thermal resistance versus lead length.

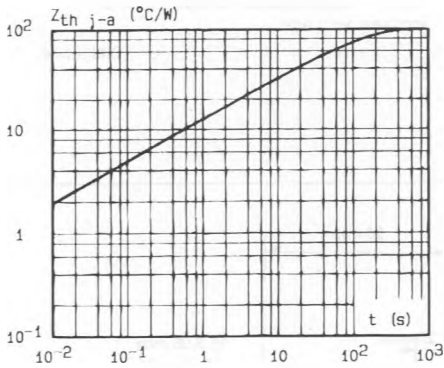

Fig.3 - Transient thermal impedance junction-ambient for mounting n°2 versus pulse duration (L = 10 mm).

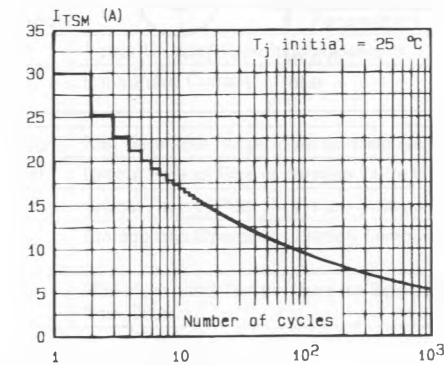
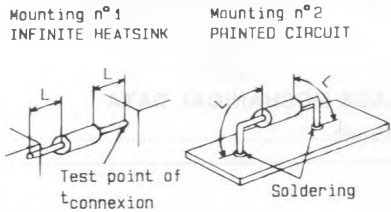

Fig.4 - Non repetitive surge peak on-state current versus number of cycles.

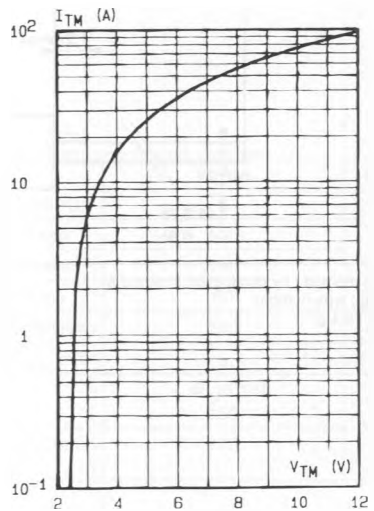

Fig.5 - Peak forward current versus peak forward voltage drop (typical values).

088TPAP3

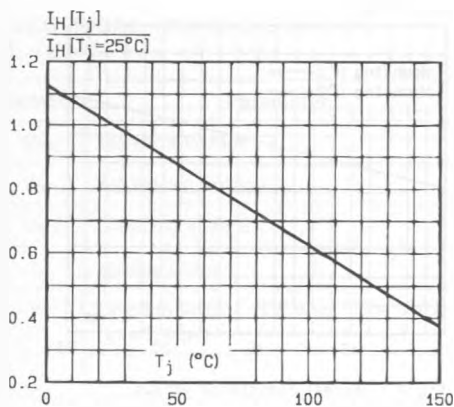

Fig.6 - Relative variation of holding current versus junction temperature.

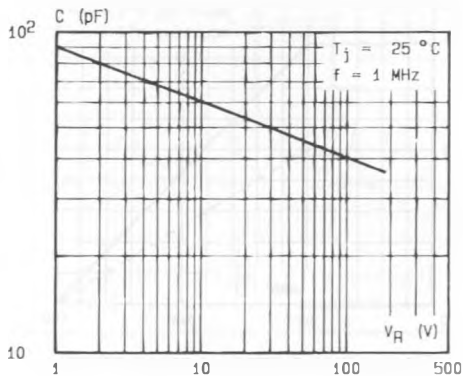
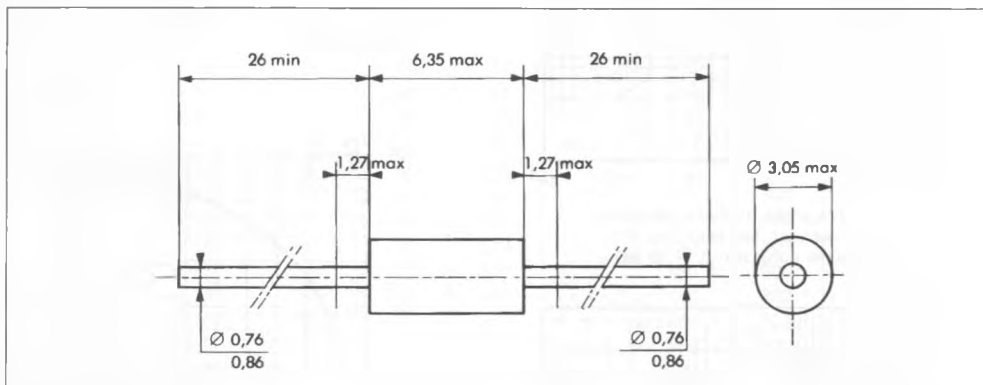

Fig.7 - Capacitance versus reverse applied voltage.

DB8TPA4

PACKAGE MECHANICAL DATA

F 126 Plastic



Cooling method : by conduction (method A)
 Marking : type number
 Weight : 0.4 g