



19X8

TRIODE-PENTODE CONVERTER

9-Pin Miniature Type

TENTATIVE DATA

RCA-19X8 is a multi-unit tube of the 9-pin miniature type containing a medium- μ triode and a sharp-cutoff pentode in one envelope. It is designed primarily for use as a combined oscillator and mixer tube in "transformerless" AM/FM receivers. The 19X8 has a 150-milliampere heater which permits series-string heater operation with other tubes having 150-milliamperes heaters.

The pentode mixer unit of the 19X8 provides low grid-No. 1-to-plate capacitance as compared with a triode mixer and also has low output capacitance. The low value of capacitance between grid No. 1 and plate minimizes feedback problems often encountered in mixer circuits operating into high-impedance plate loads. The low value of output capacitance enables the tube to work into a high-impedance plate circuit with resultant increase in mixer gain.

The 19X8 offers versatility to designers of AM/FM receivers. In the AM section, the pentode unit may be used as a pentode mixer to provide high gain; in the FM section, the pentode unit may be used either as a pentode mixer or as a triode-connected mixer depending on signal-to-noise considerations. Because triode mixers have relatively low equivalent noise resistance, they are preferred for receiver designs which do not include an rf stage. For receiver designs with an rf stage, a pentode mixer not only provides higher gain but better performance because in such designs the noise introduced by the mixer is negligible. For both the AM and the FM sections, the triode unit of the 19X8 makes a satisfactory oscillator.

GENERAL DATA

Electrical:

Heater, for Unipotential Cathode:			
Voltage (AC or DC)	18.9	volts	
Current	0.15	ampere	
Direct Interelectrode Capacitances:			
	Without External Shield	With External Shield#	
Triode Unit:			
Grid to Plate	1.4	1.4	$\mu\mu\text{f}$
Input	2.0	2.6	$\mu\mu\text{f}$
Output	0.5	1.0	$\mu\mu\text{f}$
Pentode Unit:			
Grid No. 1 to Plate	0.09 max.	0.06 max.	$\mu\mu\text{f}$
Input	4.3	4.5	$\mu\mu\text{f}$
Output	0.7	1.4	$\mu\mu\text{f}$
Pentode Grid No. 1 to Triode Plate			
	0.045 max.	0.035 max.	$\mu\mu\text{f}$
Pentode Plate to Triode Plate			
	0.040 max.	0.008 max.	$\mu\mu\text{f}$
Heater to Cathode			
	5.2	5.2	$\mu\mu\text{f}$

Direct Interelectrode Capacitances (Cont'd):			
	Without External Shield	With External Shield#	
Pentode Unit Connected as Triode:▲			
Grid No. 1 to Plate	1.4	1.3	$\mu\mu\text{f}$
Input	3.0	3.2	$\mu\mu\text{f}$
Output	1.6	2.0	$\mu\mu\text{f}$

Characteristics:

<i>Triode Unit:</i>			
Plate Voltage	100	volts	
Cathode-Bias Resistor	100	ohms	
Amplification Factor	40		
Plate Resistance (Approx.)	6900	ohms	
Transconductance	5800	μmhos	
Grid-No. 1 Bias (Approx.)			
for Plate Current of 10 μamp	-10	volts	
Plate Current	8.5	ma	
<i>Pentode Unit:</i>			
Plate Voltage	250	volts	
Grid No. 3 (Suppressor)	Connected to Cathode at Socket		
Grid-No. 2 Voltage			
	150	volts	
Cathode-Bias Resistor	200	ohms	
Plate Resistance (Approx.)	750000	ohms	
Transconductance	4600	μmhos	
Grid-No. 1 Bias (Approx.)			
for Plate Current of 10 μamp	-10	volts	
Plate Current	7.7	ma	
Grid-No. 2 Current	1.6	ma	
<i>Pentode Unit Connected as Triode:</i>			
Plate Voltage	150	volts	
Grid No. 3	Connected to Cathode at Socket		
Grid No. 2			
	Tied to Plate		
Cathode-Bias Resistor	250	ohms	
Amplification Factor	42		
Plate Resistance (Approx.)	7900	ohms	
Transconductance	4000	μmhos	
Grid-No. 1 Bias (Approx.)			
for Plate Current of 10 μamp	-10	volts	
Plate Current	7.8	ma	

CONVERTER SERVICE

Maximum Ratings, Design-Center Values:

<i>Triode Unit as Oscillator</i>			
PLATE VOLTAGE	250 max.	volts	
GRID VOLTAGE (Negative bias value)	40 max.	volts	
(Positive bias value)	0 max.	volts	
PLATE DISSIPATION	1.5 max.	watts	
GRID INPUT	0.5 max.	watt	
PEAK HEATER-CATHODE VOLTAGE:			
Heater negative with respect to cathode	100 max.	volts	
Heater positive with respect to cathode	100 max.	volts	
<i>Pentode Unit as Mixer</i>			
PLATE VOLTAGE	250 max.	volts	
GRID-No. 3 (SUPPRESSOR) VOLTAGE	0 max.	volts	
GRID-No. 2 SUPPLY VOLTAGE	250 max.	volts	
GRID-No. 2 (SCREEN) VOLTAGE	See Fig. 1		
GRID-No. 1 (CONTROL-GRID) VOLTAGE:			
Negative bias value	40 max.	volts	
Positive bias value	0 max.	volts	
PLATE DISSIPATION	2.0 max.	watts	
GRID-No. 2 INPUT	0.4 max.	watt	
PEAK HEATER-CATHODE VOLTAGE:			
Heater negative with respect to cathode	100 max.	volts	
Heater positive with respect to cathode	100 max.	volts	



Pentode Unit as Triode-Connected Mixer[▲]

PLATE VOLTAGE.	250 max.	volts
GRID-NO.1 (CONTROL-GRID) VOLTAGE:		
Negative bias value.	40 max.	volts
Positive bias value.	0 max.	volts
PLATE DISSIPATION.	2.4 max.	watts
PEAK HEATER-CATHODE VOLTAGE:		
Heater negative with respect to cathode.	100 max.	volts
Heater positive with respect to cathode.	100 max.	volts

Typical Operation:

Triode Unit as 250-Mc Oscillator:●

Plate Voltage.	150	volts
Grid Resistor.	2700	ohms
Plate Current.	13	ma
Grid Current.	3.6	ma
Power Output (Approx.)	0.5	watt

Pentode Unit as Mixer:*

Plate Voltage.	150	volts
Grid No.3 (Suppressor)	Connected to Cathode at Socket	
Grid-No.2 Voltage.	150	volts
Mixer Grid-No.1 Supply Voltage	-3.5	volts
Oscillator Voltage at Mixer		
Grid No.1.	2.6 rms	volts
Mixer Grid-No.1-Circuit Resistance	120000	ohms
Conversion Transconductance.	2100	μmhos
Plate Current.	6.2	ma
Grid-No.2 Current.	1.8	ma
Grid-No.1 Current.	2.0	μamp

Pentode Unit as Triode-Connected Mixer:▲

Plate Voltage.	150	volts
Grid-No.1 Supply Voltage	-3.5	volts
Oscillator Voltage at Grid No.1	2.6 rms	volts
Grid-No.1-Circuit Resistance	120000	ohms
Conversion Transconductance.	2800	μmhos
Plate Current.	7.8	ma
Grid-No.1 Current.	2.0	μamp

Maximum Circuit Values:

Grid-No.1-Circuit Resistance:		
For fixed-bias operation	0.1 max.	megohm
For cathode-bias operation	0.5 max.	megohm

- * According to RTMA Standard ET-109A with external shield No.315 tied to cathode.
- ▲ Grid No.3 connected to cathode; grid No.2 connected to plate.
- * With separate excitation and triode unit grounded.
- In FM receivers, it is generally desirable to operate the oscillator with less power input than shown in the tabulated data in order to avoid over excitation and excessive oscillator radiation.

OPERATING CONSIDERATIONS

The maximum ratings in the tabulated data for the 19X8 are working design-center maximums established according to the standard design-center system of rating electron tubes. Tubes so rated will give satisfactory performance in equipment designed so that these maximum ratings will not be exceeded when the equipment is operated from ac or dc power-line supplies whose normal voltage including normal variations fall within ± 10 per cent of line-center voltage value of 117 volts.

When the 19X8 is used as the converter in AM broadcast receivers, it is important that the tuned plate-load impedance of the first if coil does not exceed 75000 ohms. Any higher value will cause excessive degeneration due to the feedback in the pentode mixer unit.

DIMENSIONAL OUTLINE

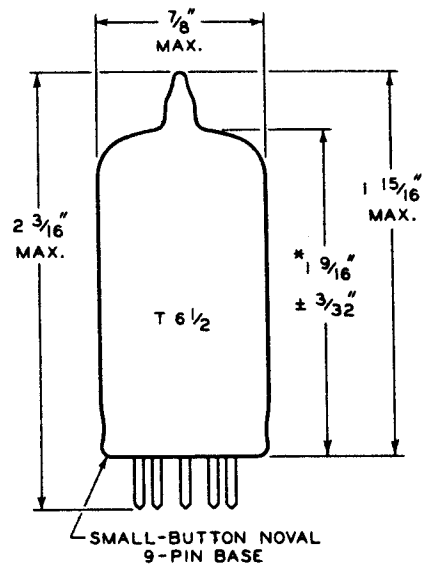

* MEASURED FROM BASE SEAT TO BULB-TOP LINE AS DETERMINED BY RING GAUGE OF 7/16" I.D.

**SOCKET CONNECTIONS
Bottom View**

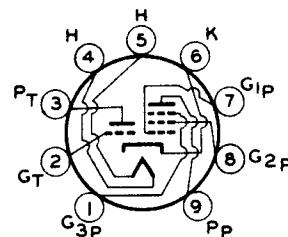

- PIN 1: PENTODE GRID No.3
- PIN 2: TRIODE GRID
- PIN 3: TRIODE PLATE
- PIN 4: HEATER
- PIN 5: HEATER
- PIN 6: CATHODE
- PIN 7: PENTODE GRID No.1
- PIN 8: PENTODE GRID No.2
- PIN 9: PENTODE PLATE

Devices and arrangements shown or described herein may use patents of RCA or others. Information contained herein is furnished without responsibility by RCA for its use and without prejudice to RCA's patent rights.

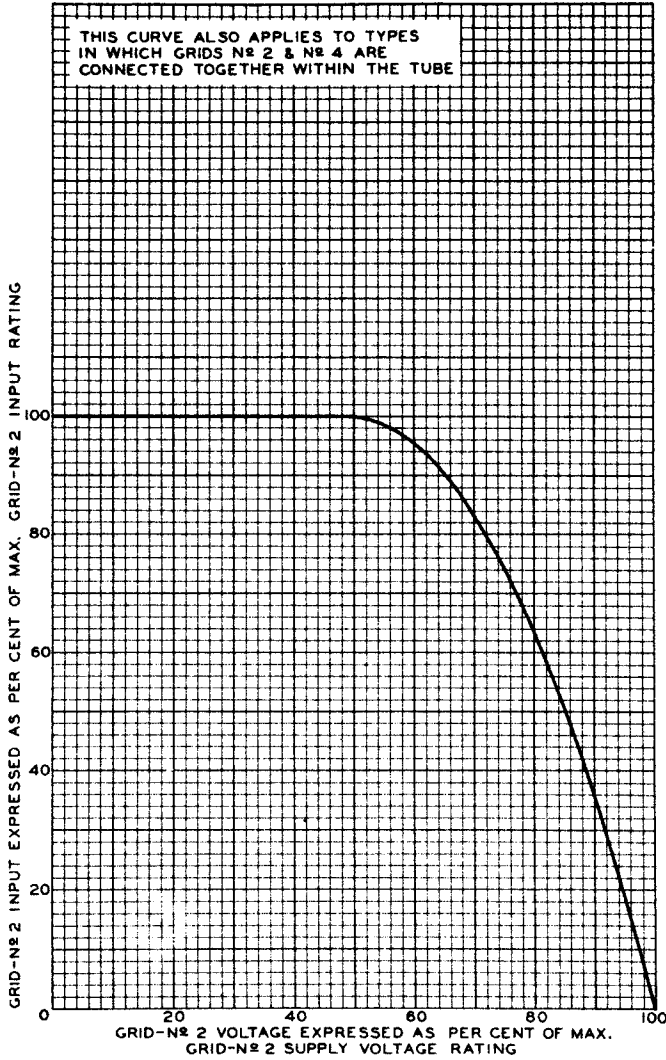

92CM-7586

Fig. 1 - Grid-No. 2 Input Rating Curve of Type 19X8.

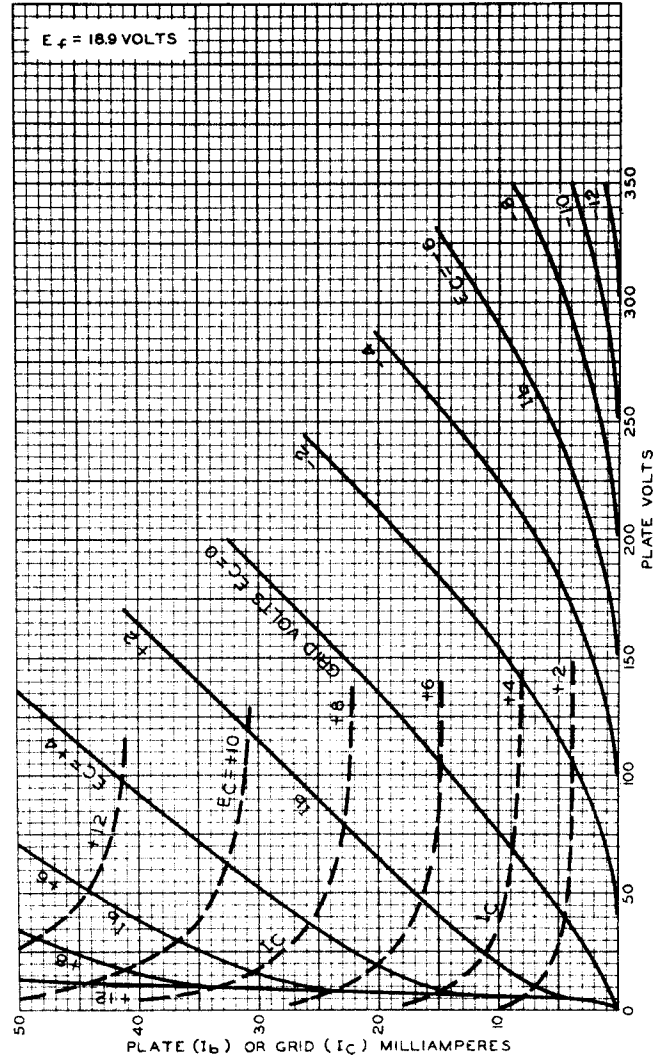

92CM-7779

Fig. 2 - Average Plate Characteristics of 19X8 Triode Unit.

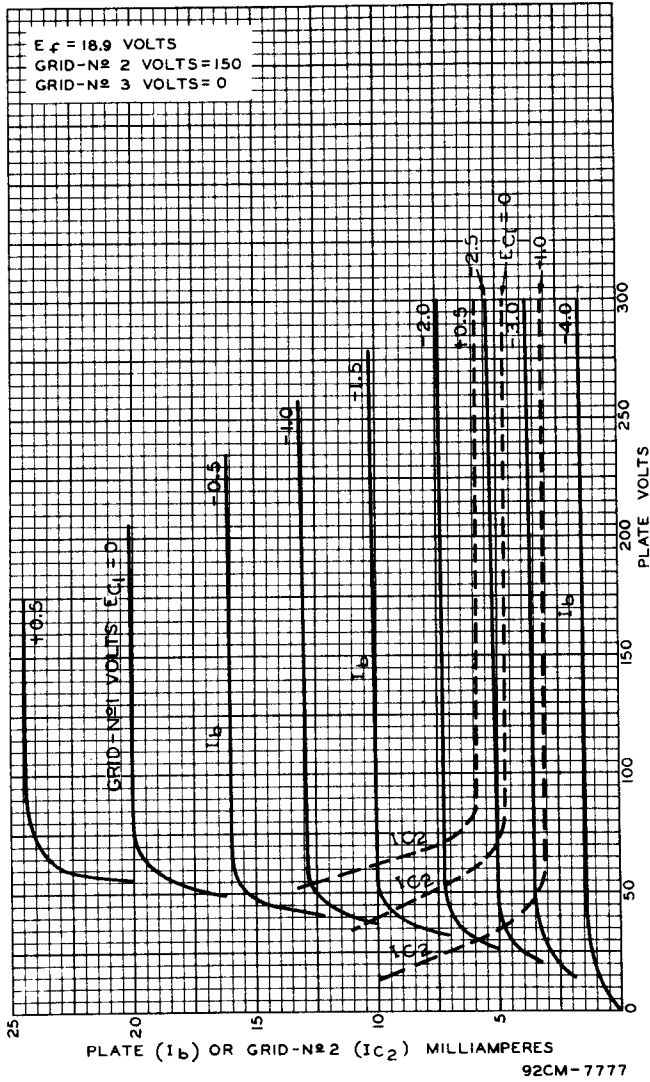

Fig. 3 - Average Plate Characteristics of 19X8 Pentode Unit.

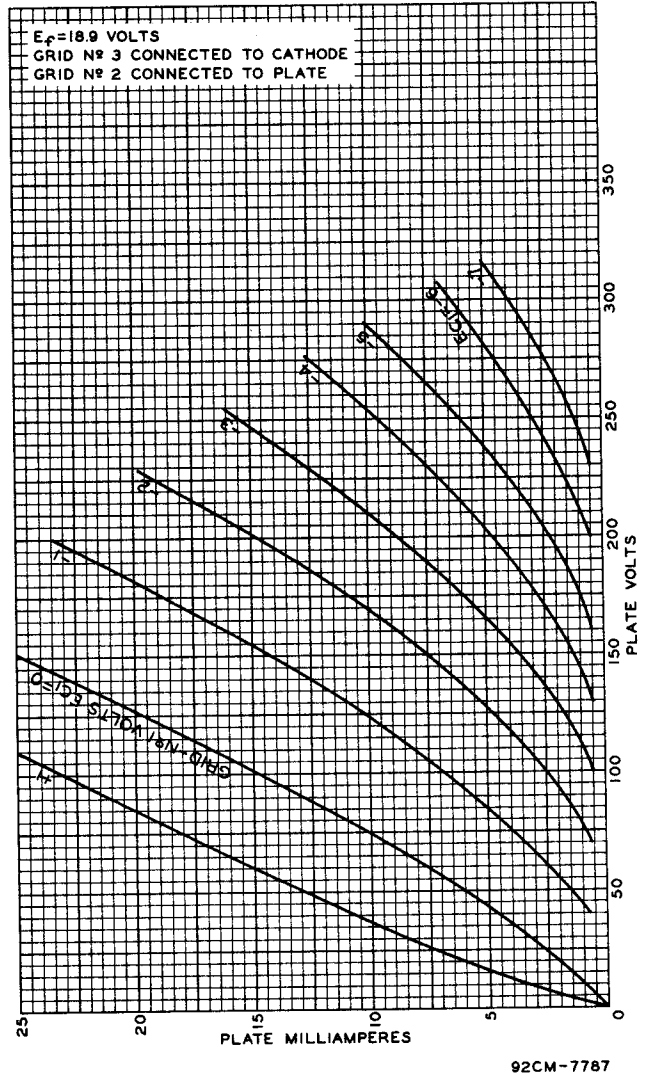
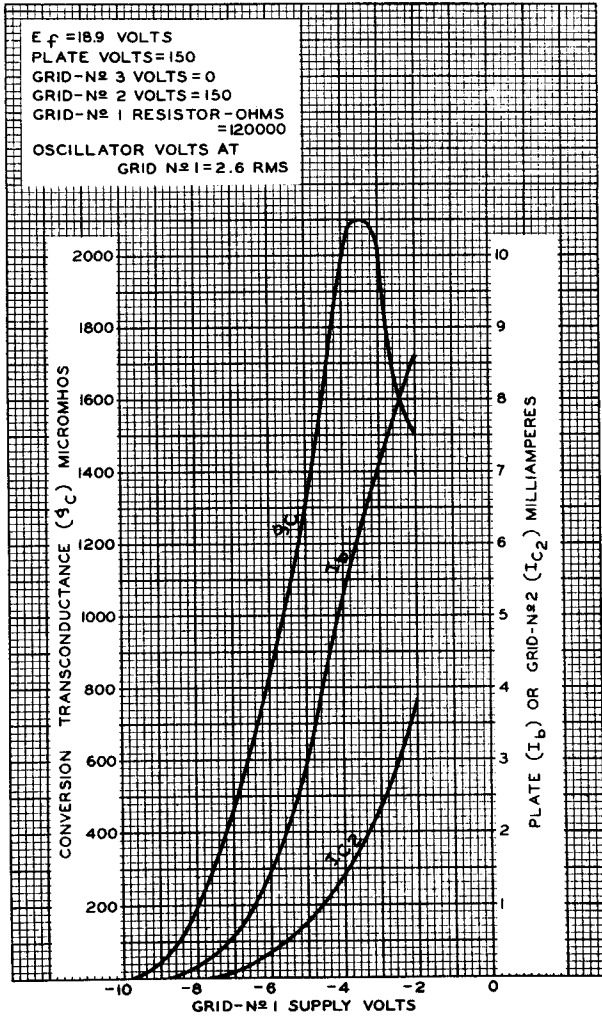
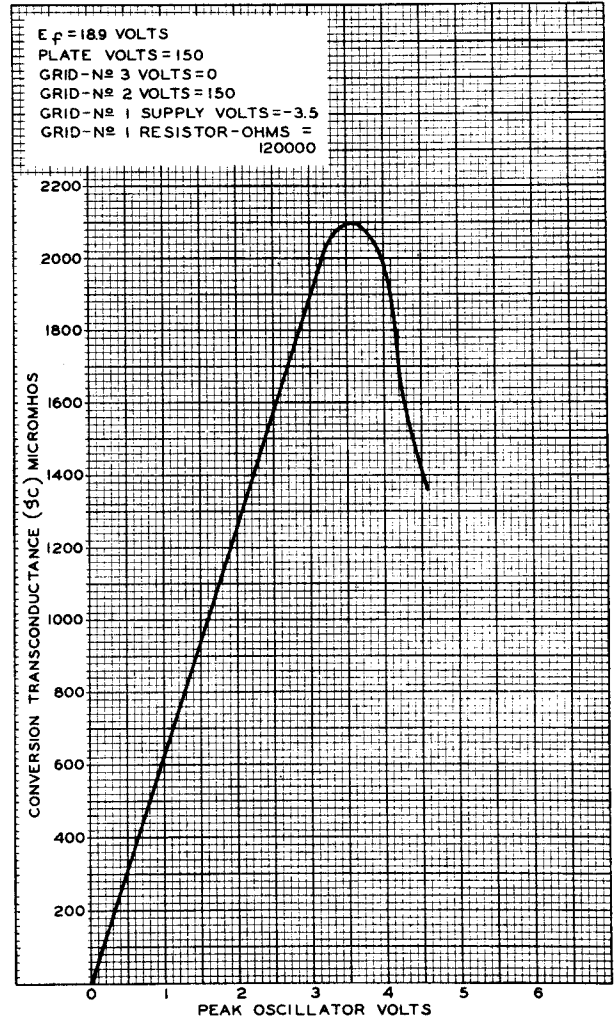

Fig. 4 - Average Plate Characteristics of 19X8 Pentode Unit Connected as Triode.



92CM-7780

Fig. 5 - Operation Characteristic with Separate Oscillator Excitation of 19X8 Pentode Unit.



92CM-7778

Fig. 6 - Operation Characteristic with Separate Oscillator Excitation of 19X8 Pentode Unit.

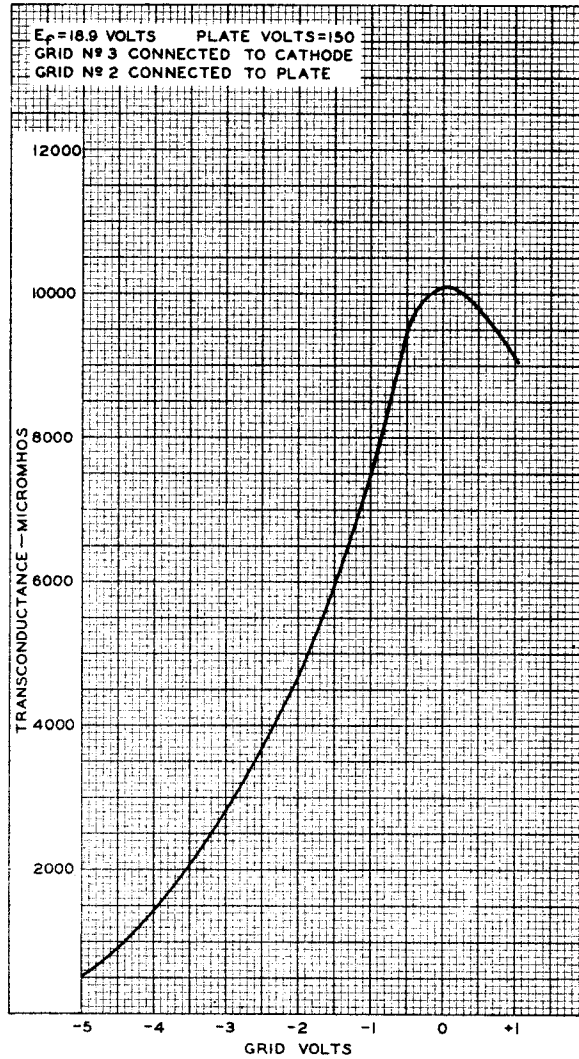

92CM-7788

Fig. 7 - Average Characteristic of 19X8
 Pentode Unit Connected as Triode.