

(Units : mm)

## • DIP22

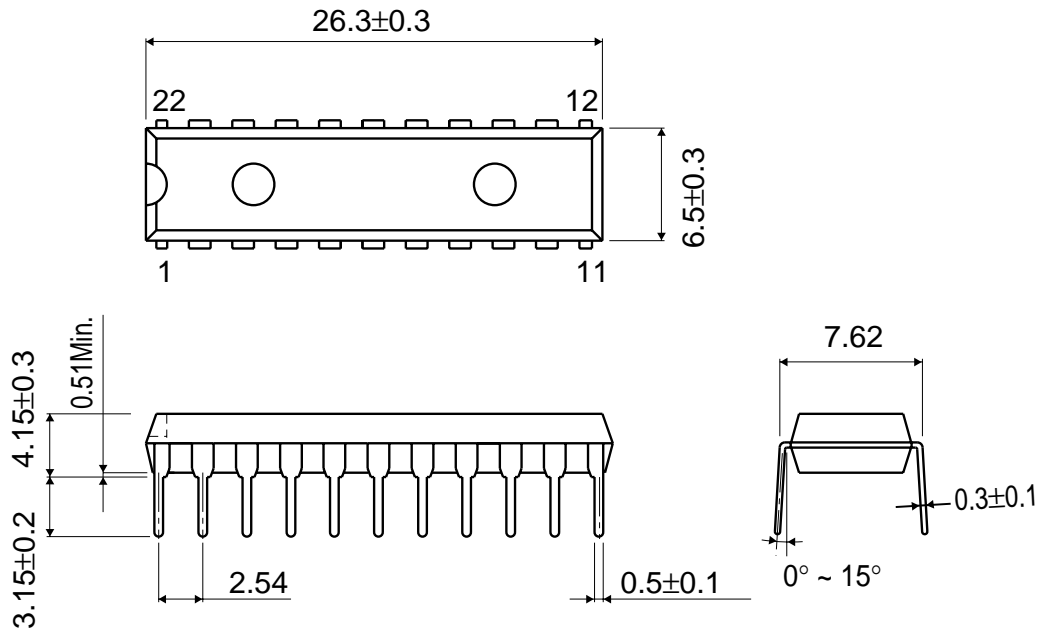

\* The contents described herein are subject to change without notice.