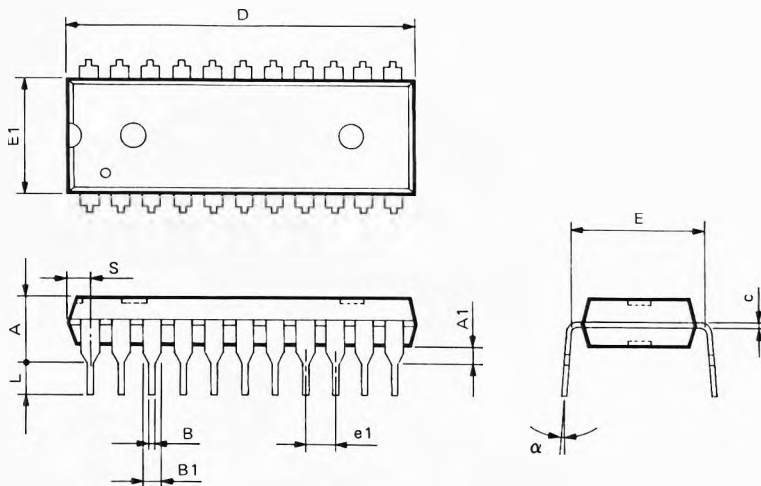

P-DIP 22L Outline Dimension

Symbol	Dimensions in inch	Dimensions in mm
A	0.190 max.	4.826 Max.
A1	0.020 Min.	0.508 Min.
B	0.018 + 0.004 - 0.002	0.457 + 0.102 - 0.051
B1	0.060 + 0.004 - 0.002	1.524 + 0.102 - 0.051
c	0.010 + 0.004 - 0.002	0.254 + 0.102 - 0.051
D	1.090 (1.120 Max.)	27.686 (28.448 Max.)
E	0.400 ± 0.010	10.160 ± 0.254
E1	0.350 (0.375 Max.)	8.890 (9.525 Max.)
e1	0.100 ± 0.010	2.540 ± 0.254
L	0.130 ± 0.010	3.302 ± 0.254
α	0° ~ 15°	0° ~ 15°
S	0.065 Max.	1.651 Max.