

N-Channel Enhancement-Mode MOS Transistors

Product Summary

Part Number	$V_{(BR)DSS}$ Min (V)	$r_{DS(on)}$ Max (Ω)	$V_{GS(th)}$ (V)	I_D (A)
2N6659	35	1.8 @ $V_{GS} = 10$ V	0.8 to 2	1.4
2N6660	60	3 @ $V_{GS} = 10$ V	0.8 to 2	1.1
VQ1004J/P	60	3.5 @ $V_{GS} = 10$ V	0.8 to 2.5	0.46

Features

- Low On-Resistance: 1.3 Ω
- Low Threshold: 1.7 V
- Low Input Capacitance: 35 pF
- Fast Switching Speed: 8 ns
- Low Input and Output Leakage

Benefits

- Low Offset Voltage
- Low-Voltage Operation
- Easily Driven Without Buffer
- High-Speed Circuits
- Low Error Voltage

Applications

- Direct Logic-Level Interface: TTL/CMOS
- Drivers: Relays, Solenoids, Lamps, Hammers, Displays, Memories, Transistors, etc.
- Battery Operated Systems
- Solid-State Relays

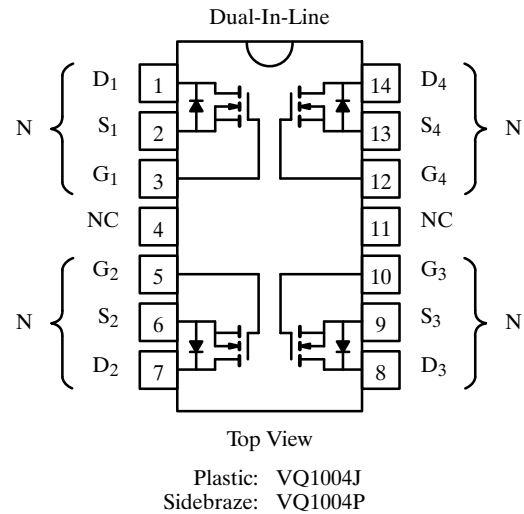
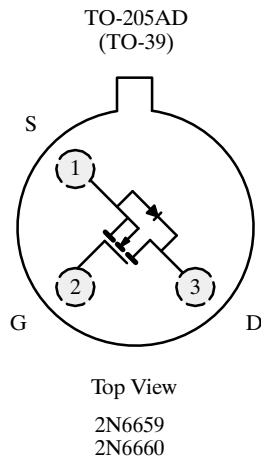

Absolute Maximum Ratings ($T_C = 25^\circ\text{C}$ Unless Otherwise Noted)

Parameter	Symbol	2N6659	2N6660	Single		Total Quad	Unit	
				VQ1004J	VQ1004P	VQ1004J/P		
Drain-Source Voltage	V_{DS}	35	60	60	60		V	
Gate-Source Voltage	V_{GS}	± 20	± 20	± 30	± 20			
Continuous Drain Current ($T_J = 150^\circ\text{C}$)	I_D	$T_C = 25^\circ\text{C}$	1.4	1.1	0.46	± 0.46	A	
		$T_C = 100^\circ\text{C}$	1	0.8	0.26	0.26		
Pulsed Drain Current ^a	I_{DM}	3	3	2	2			
Power Dissipation	P_D	$T_C = 25^\circ\text{C}$	6.25	6.25	1.3	1.3	2	W
		$T_C = 100^\circ\text{C}$	2.5	2.5	0.52	0.52	0.8	
Maximum Junction-to-Ambient ^b	R_{thJA}	170	170	0.96	0.96	62.5	$^\circ\text{C}/\text{W}$	
Maximum Junction-to-Case	R_{thJC}	20	20				$^\circ\text{C}/\text{W}$	
Operating Junction and Storage Temperature Range	T_J, T_{stg}	-55 to 150						$^\circ\text{C}$

Notes

- a. Pulse width limited by maximum junction temperature.
b. This parameter not registered with JEDEC.

2N6659/2N6660, VQ1004J/P

Specifications^a

Parameter	Symbol	Test Conditions	Typ ^b	Limits						Unit	
				2N6659		2N6660		VQ1004J/P			
				Min	Max	Min	Max	Min	Max		
Static											
Drain-Source Breakdown Voltage	$V_{(BR)DSS}$	$V_{GS} = 0\text{ V}, I_D = 10\ \mu\text{A}$	75	35		60		60		V	
Gate-Threshold Voltage	$V_{GS(th)}$	$V_{DS} = V_{GS}, I_D = 1\ \text{mA}$	1.7	0.8	2	0.8	2	0.8	2.5		
Gate-Body Leakage	I_{GSS}	$V_{DS} = 0\ \text{V}, V_{GS} = \pm 15\ \text{V}$ $T_C = 125^\circ\text{C}$			± 100		± 100		± 100	nA	
					± 500		± 500		± 500		
Zero Gate Voltage Drain Current	I_{DSS}	$V_{DS} = 60\ \text{V}, V_{GS} = 0\ \text{V}$ $V_{DS} = 35\ \text{V}, V_{GS} = 0\ \text{V}$ $V_{DS} = 48\ \text{V}, V_{GS} = 0\ \text{V}$ $T_C = 125^\circ\text{C}$ $V_{DS} = 28\ \text{V}, V_{GS} = 0\ \text{V}$ $T_C = 125^\circ\text{C}$					10			μA	
					10						
								500			500
					500						
On-State Drain Current ^c	$I_{D(on)}$	$V_{DS} = 10\ \text{V}, V_{GS} = 10\ \text{V}$	3	1.5		1.5		1.5		A	
Drain-Source On-Resistance ^c	$r_{DS(on)}$	$V_{GS} = 5\ \text{V}, I_D = 0.3\ \text{A}^e$ $V_{GS} = 10\ \text{V}, I_D = 1\ \text{A}$ $T_C = 125^\circ\text{C}^e$	2		5		5		5	Ω	
			1.3		1.8		3		3.5		
			2.4		3.6		4.2		4.9		
Forward Transconductance ^c	g_{fs}	$V_{DS} = 10\ \text{V}, I_D = 0.5\ \text{A}$	350	170		170		170		mS	
Common Source Output Conductance ^c	g_{os}	$V_{DS} = 10\ \text{V}, I_D = 0.1\ \text{A}$	1								
Diode Forward Voltage	V_{SD}	$I_S = 0.99\ \text{A}, V_{GS} = 0\ \text{V}$	0.8							V	
Dynamic											
Input Capacitance	C_{iss}	$V_{DS} = 24\ \text{V}, V_{GS} = 0\ \text{V}$ $f = 1\ \text{MHz}$	35		50		50		60	pF	
Output Capacitance	C_{oss}		25		40		40		50		
Reverse Transfer Capacitance	C_{rss}		7		10		10		10		
Drain-Source Capacitance	C_{ds}		30		40		40				
Switching^d											
Turn-On Time	t_{ON}	$V_{DD} = 25\ \text{V}, R_L = 23\ \Omega$ $I_D \cong 1\ \text{A}, V_{GEN} = 10\ \text{V}$ $R_G = 25\ \Omega$	8		10		10		10	ns	
Turn-Off Time	t_{OFF}		8.5		10		10		10		

Notes

- $T_A = 25^\circ\text{C}$ unless otherwise noted.
- For DESIGN AID ONLY, not subject to production testing.
- Pulse test: $PW \leq 80\ \mu\text{s}$ duty cycle $\leq 1\%$.
- Switching time is essentially independent of operating temperature.
- This parameter not registered with JEDEC on 2N6659 and 2N6660.

VNDQ06

Typical Characteristics (25°C Unless Otherwise Noted)

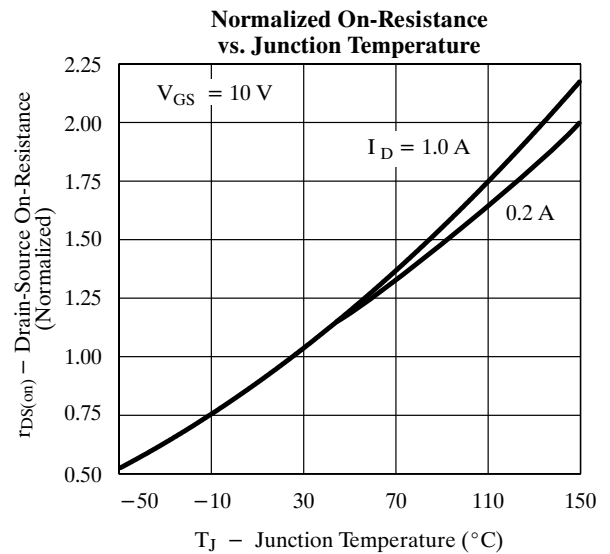
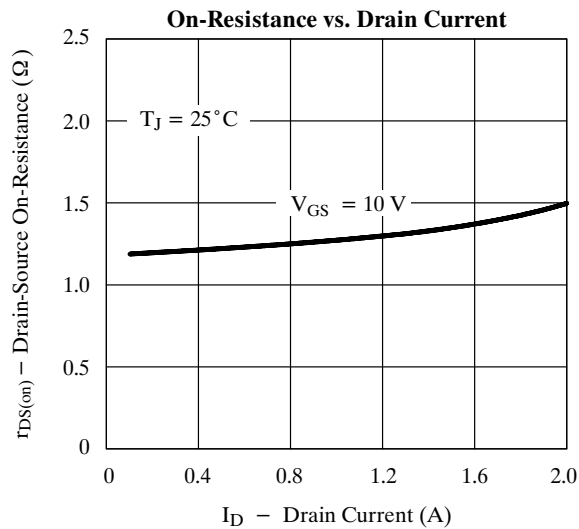
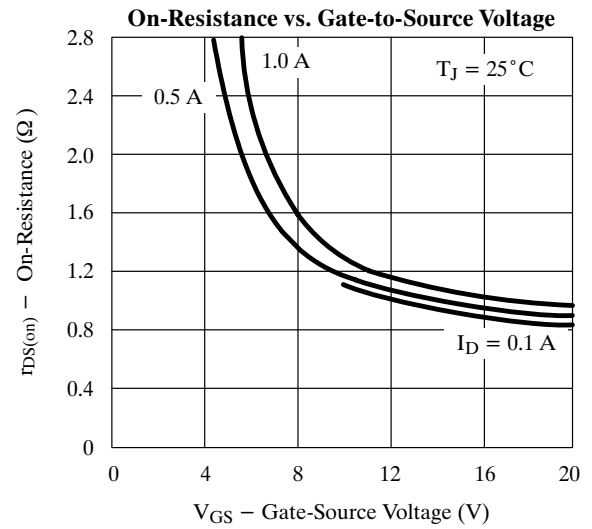
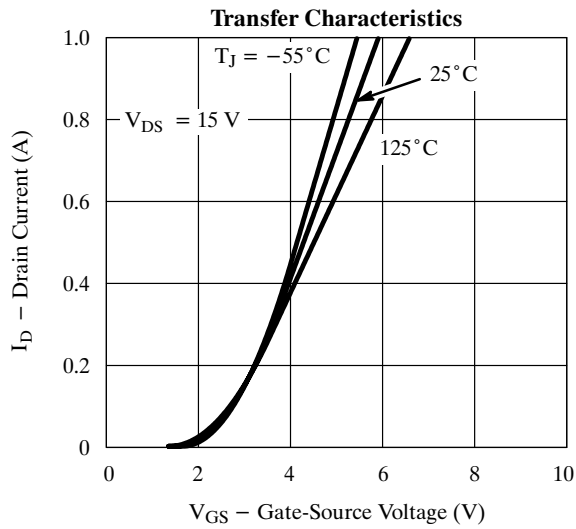
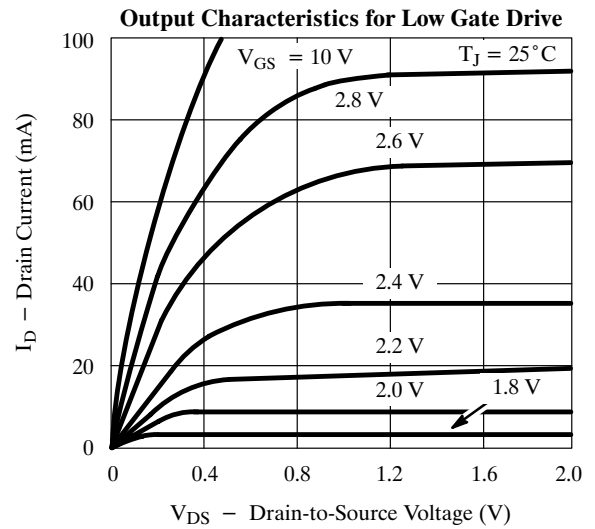
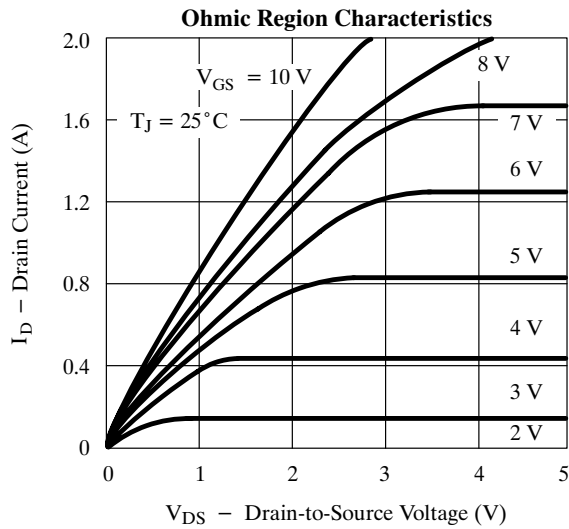

2N6659/2N6660, VQ1004J/P

Typical Characteristics (25°C Unless Otherwise Noted)

