

TOSHIBA Transistor Silicon NPN Epitaxial Planar Type (PCT process)

2SC2715

High Frequency Amplifier Applications

- High power gain: $G_{pe} = 2\text{dB}$ (typ.) ($f = 10.7\text{ MHz}$)
- Recommended for FM IF, OSC stage and AM CONV. IF stage.

Maximum Ratings ($T_a = 25^\circ\text{C}$)

Characteristics	Symbol	Rating	Unit
Collector-base voltage	V_{CBO}	35	V
Collector-emitter voltage	V_{CEO}	30	V
Emitter-base voltage	V_{EBO}	4	V
Collector current	I_C	50	mA
Base current	I_B	10	mA
Collector power dissipation	P_C	150	mW
Junction temperature	T_j	125	$^\circ\text{C}$
Storage temperature range	T_{stg}	-55~125	$^\circ\text{C}$

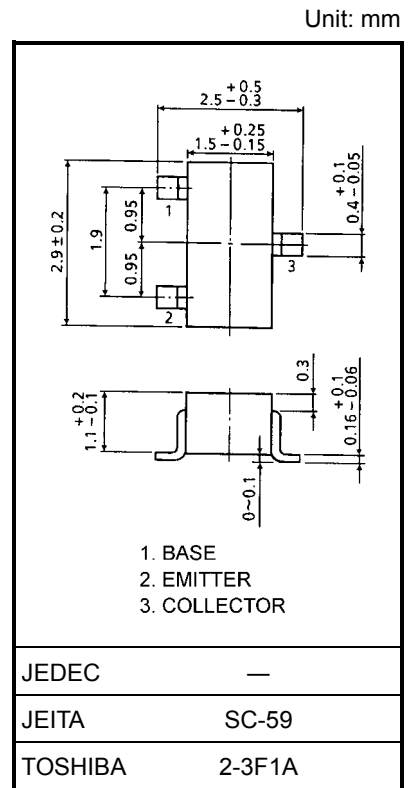

Electrical Characteristics ($T_a = 25^\circ\text{C}$)

Weight: 0.012 g (typ.)

Characteristics	Symbol	Test Condition	Min	Typ.	Max	Unit
Collector cut-off current	I_{CBO}	$V_{CB} = 35\text{ V}, I_E = 0$	—	—	0.1	μA
Emitter cut-off current	I_{EBO}	$V_{EB} = 4\text{ V}, I_C = 0$	—	—	0.1	μA
DC current gain	h_{FE} (Note)	$V_{CE} = 12\text{ V}, I_C = 2\text{ mA}$	40	—	240	
Collector-emitter saturation voltage	$V_{CE}(\text{sat})$	$I_C = 10\text{ mA}, I_B = 1\text{ mA}$	—	—	0.4	V
Base-emitter voltage	V_{BE}	$I_C = 10\text{ mA}, I_B = 1\text{ mA}$	—	—	1.0	V
Transition frequency	f_T	$V_{CE} = 10\text{ V}, I_C = 1\text{ mA}$	100	—	400	MHz
Collector output capacitance	C_{ob}	$V_{CB} = 10\text{ V}, I_E = 0, f = 1\text{ MHz}$	—	2.0	3.2	pF
Collector-base time constant	$C_c \cdot r_{bb'}$	$V_{CE} = 10\text{ V}, I_E = -1\text{ mA}, f = 30\text{ MHz}$	—	—	50	ps
Power gain	G_{pe}	$V_{CC} = 6\text{ V}, I_E = -1\text{ mA}, f = 10.7\text{ MHz}$ (Figure 1)	27	30	33	dB

Note: h_{FE} classification R: 40~80, O: 70~140, Y: 120~240

y Parameter (typ.)

(1) (common emitter $f = 455 \text{ MHz}$, $T_a = 25^\circ\text{C}$)

Characteristics	Symbol	2SC2715-R	2SC2715-O	2SC2715-Y	Unit
Collector-emitter voltage	V_{CE}	6	6	6	V
Emitter current	I_E	-1	-1	-1	mA
Input conductance	g_{ie}	0.58	0.41	0.26	mS
Input capacitance	C_{ie}	53	46	38	pF
Output conductance	g_{oe}	1.9	2.7	4.8	μS
Output capacitance	C_{oe}	2.6	2.8	3.6	pF
Forward transfer admittance	$ y_{fe} $	38	38	38	mS
Phase angle of forward transfer admittance	θ_{fe}	-0.79	-0.83	-0.92	$^\circ$
Reverse transfer admittance	$ y_{re} $	5.7	5.7	6.2	μS
Phase angle of reverse transfer admittance	θ_{re}	-90	-90	-90	$^\circ$

(2) (common emitter $f = 10.7 \text{ MHz}$, $T_a = 25^\circ\text{C}$)

Characteristics	Symbol	2SC2715-R	2SC2715-O	2SC2715-Y	Unit
Collector-emitter voltage	V_{CE}	6	6	6	V
Emitter current	I_E	-1	-1	-1	mA
Input conductance	g_{ie}	1.04	0.85	0.65	mS
Input capacitance	C_{ie}	49	43	36	pF
Output conductance	g_{oe}	10	15	28	μS
Output capacitance	C_{oe}	2.7	2.9	3.6	pF
Forward transfer admittance	$ y_{fe} $	37	37	37	mS
Phase angle of forward transfer admittance	θ_{fe}	-9.6	-10.4	-11.5	$^\circ$
Reverse transfer admittance	$ y_{re} $	120	120	140	μS
Phase angle of reverse transfer admittance	θ_{re}	-90	-90	-90	$^\circ$

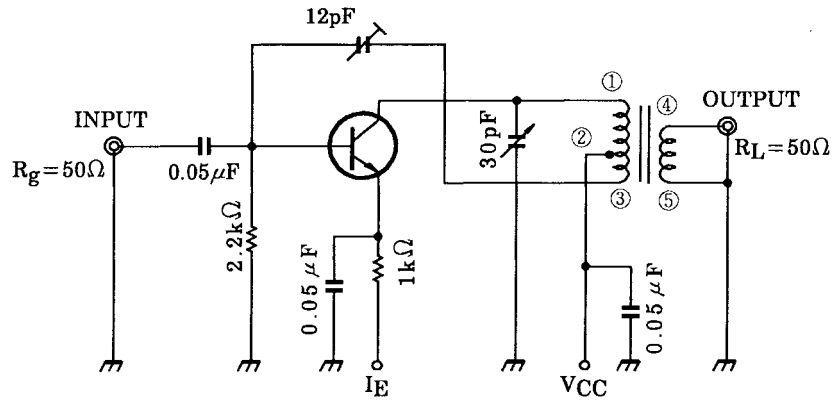

- T : ①-② 0.1mmφ UEW 20T
 ②-③ 0.1mmφ UEW 8T
 ④-⑤ 0.1mmφ UEW 2T

Figure 1 NF, Gpe Test Circuit

Marking

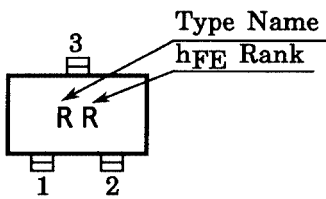

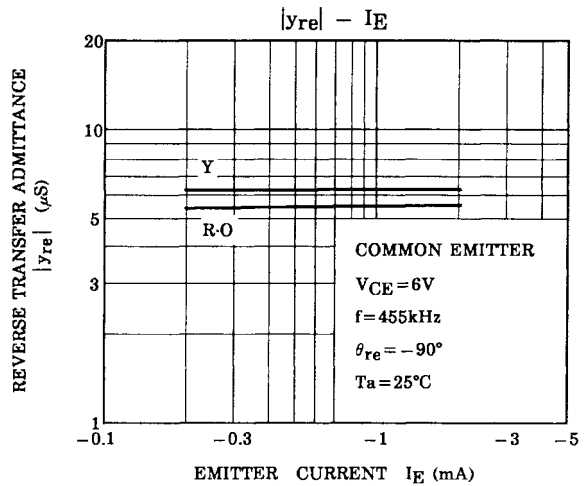
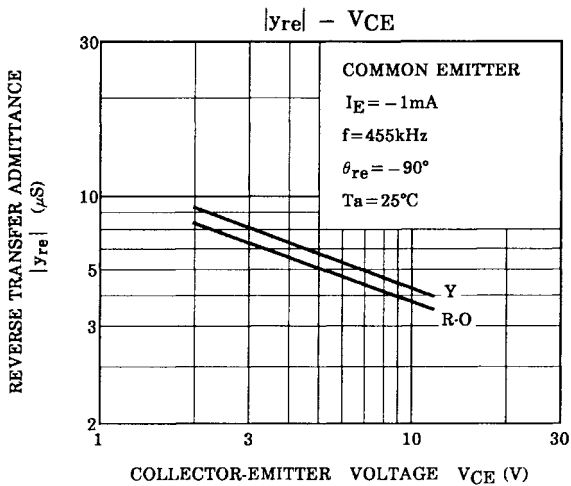
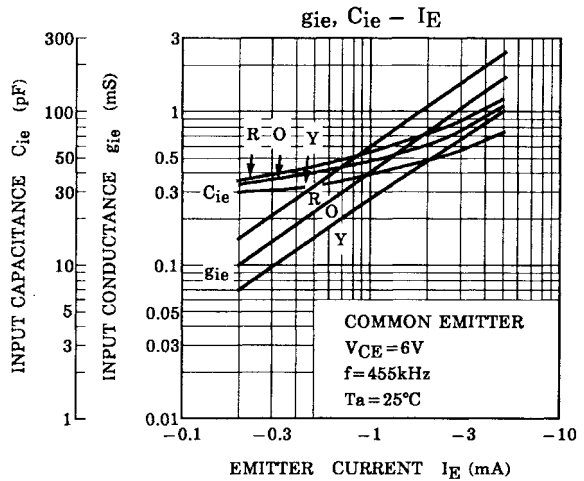
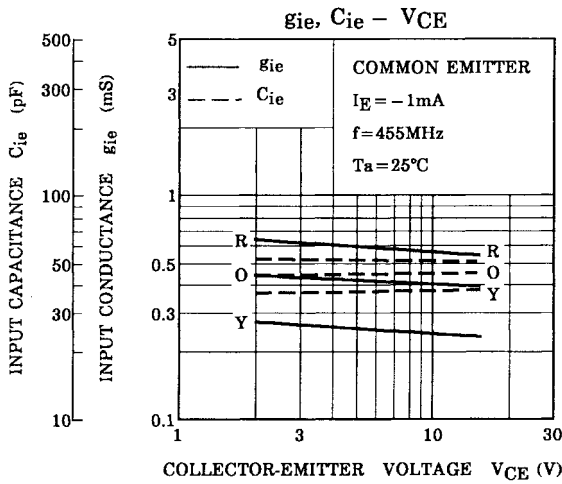
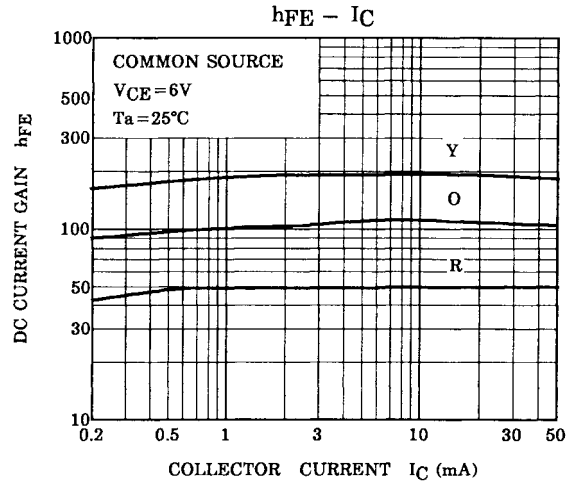
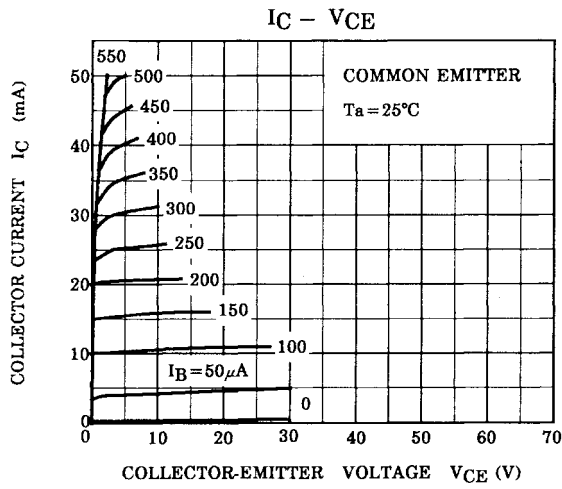

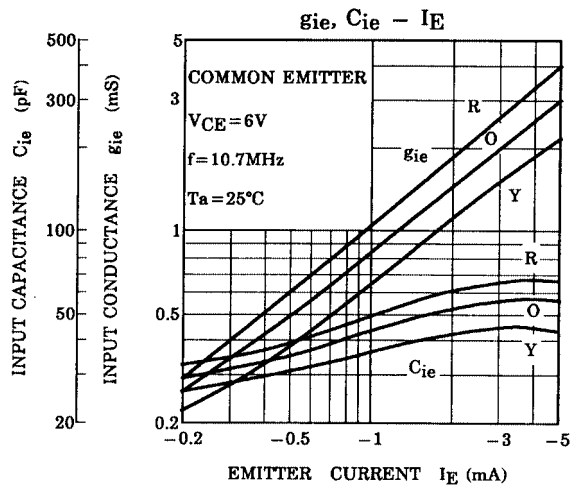
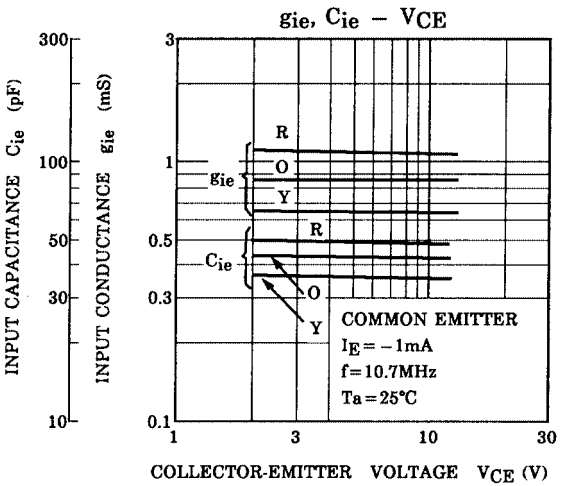
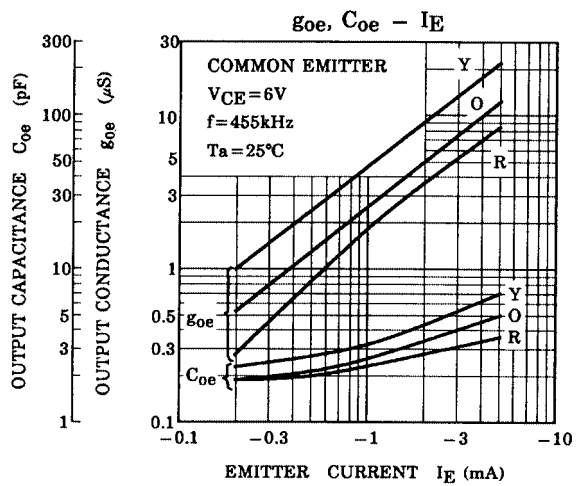
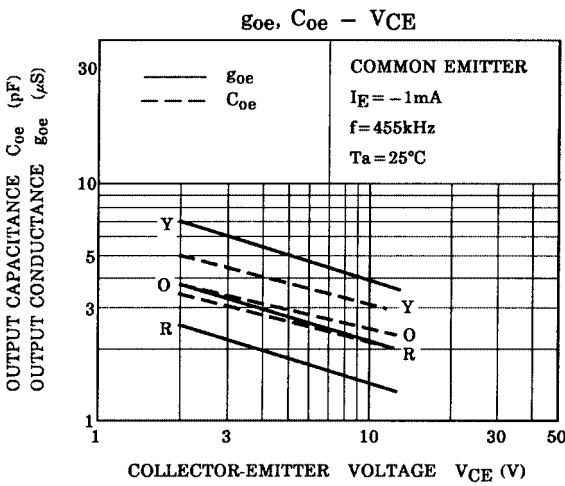
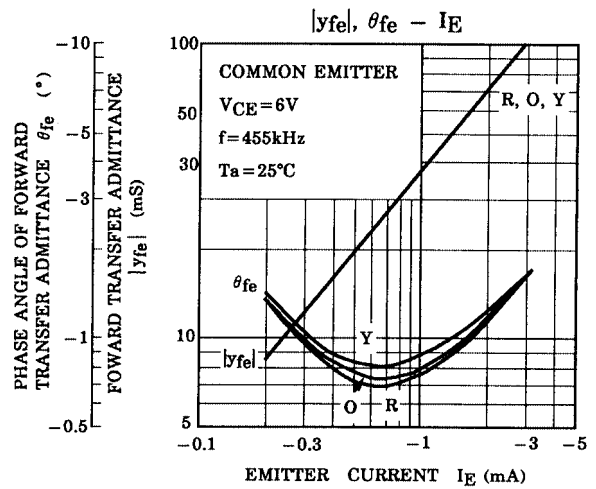
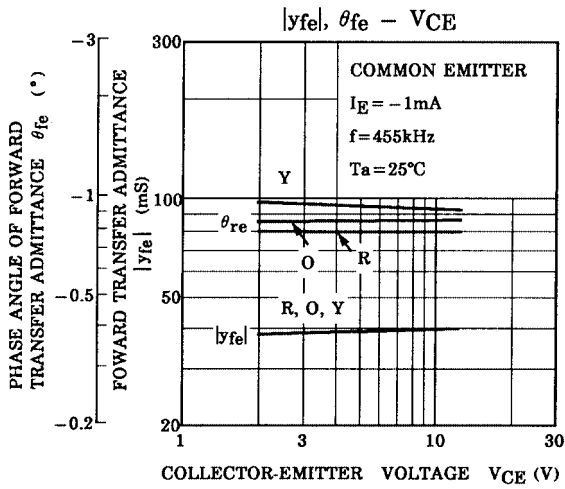

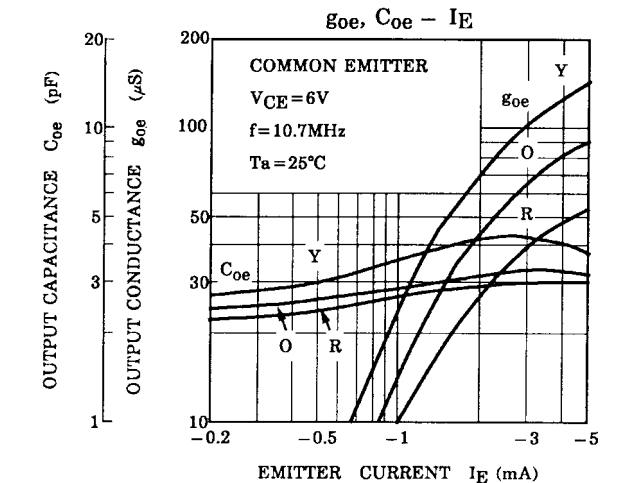
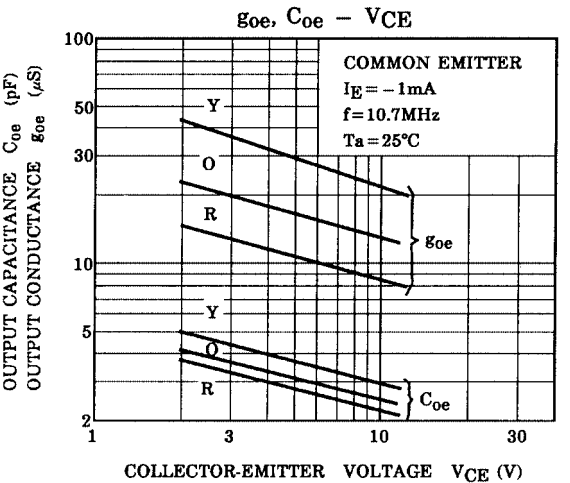
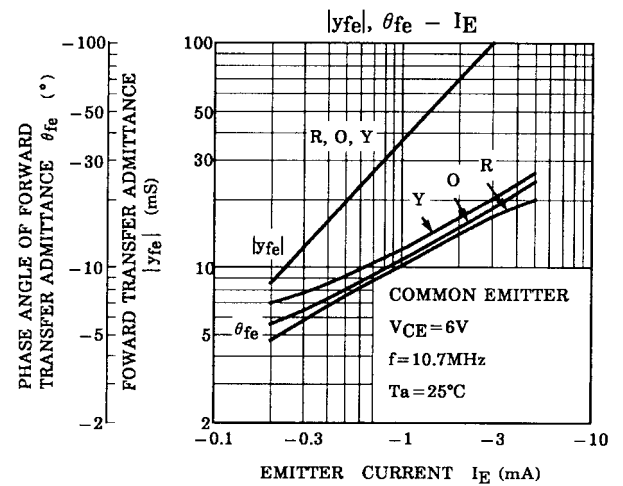
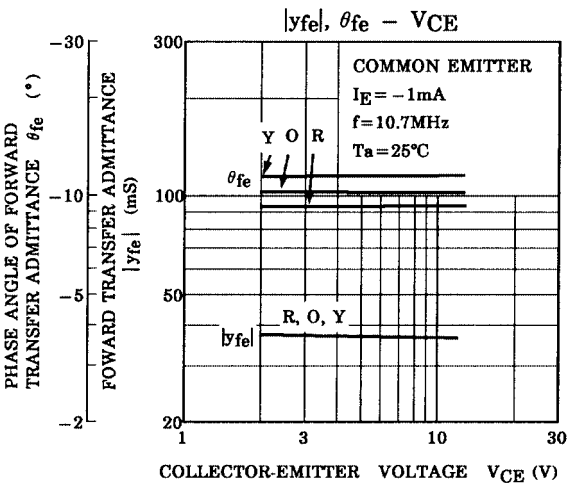
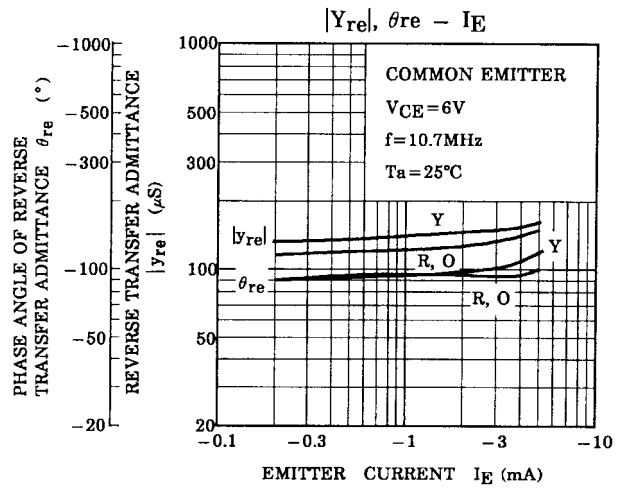
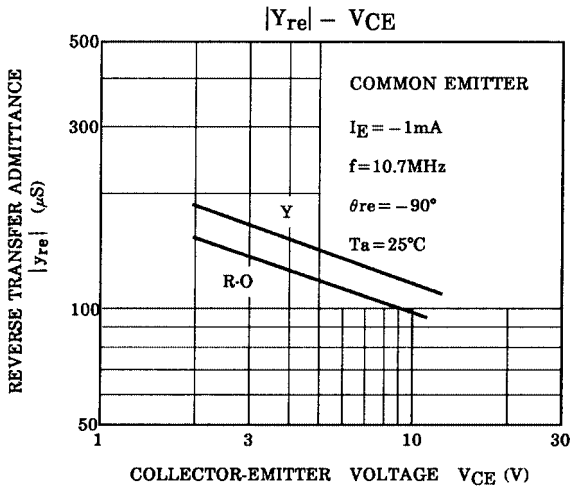

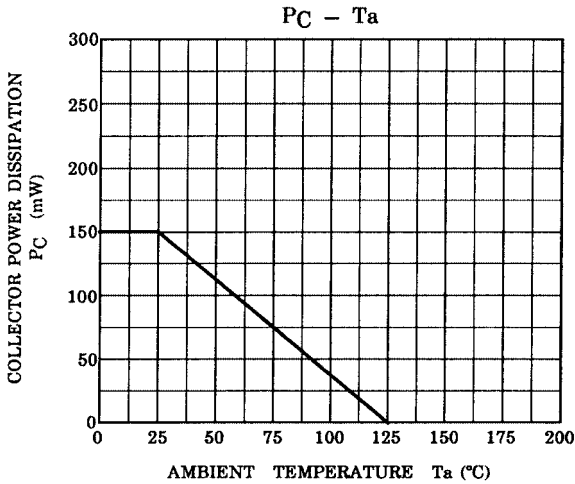

RESTRICTIONS ON PRODUCT USE

000707EAA

- TOSHIBA is continually working to improve the quality and reliability of its products. Nevertheless, semiconductor devices in general can malfunction or fail due to their inherent electrical sensitivity and vulnerability to physical stress. It is the responsibility of the buyer, when utilizing TOSHIBA products, to comply with the standards of safety in making a safe design for the entire system, and to avoid situations in which a malfunction or failure of such TOSHIBA products could cause loss of human life, bodily injury or damage to property.
In developing your designs, please ensure that TOSHIBA products are used within specified operating ranges as set forth in the most recent TOSHIBA products specifications. Also, please keep in mind the precautions and conditions set forth in the "Handling Guide for Semiconductor Devices," or "TOSHIBA Semiconductor Reliability Handbook" etc..
- The TOSHIBA products listed in this document are intended for usage in general electronics applications (computer, personal equipment, office equipment, measuring equipment, industrial robotics, domestic appliances, etc.). These TOSHIBA products are neither intended nor warranted for usage in equipment that requires extraordinarily high quality and/or reliability or a malfunction or failure of which may cause loss of human life or bodily injury ("Unintended Usage"). Unintended Usage include atomic energy control instruments, airplane or spaceship instruments, transportation instruments, traffic signal instruments, combustion control instruments, medical instruments, all types of safety devices, etc.. Unintended Usage of TOSHIBA products listed in this document shall be made at the customer's own risk.
- The information contained herein is presented only as a guide for the applications of our products. No responsibility is assumed by TOSHIBA CORPORATION for any infringements of intellectual property or other rights of the third parties which may result from its use. No license is granted by implication or otherwise under any intellectual property or other rights of TOSHIBA CORPORATION or others.
- The information contained herein is subject to change without notice.